

RESEARCH

Open Access

# Low PAPR space frequency block coding for multiuser MIMO SC-FDMA systems: specific issues for users with different spectral allocations

Cristina Ciochina\*, David Mottier and Damien Castelain

## Abstract

Single-carrier space frequency block coding (SC-SFBC) is an innovative mapping scheme suitable for implementing transmit diversity in single-carrier frequency division multiple access (SC-FDMA) systems. The main advantage of SC-SFBC is that it preserves the low envelope variations of SC-FDMA, which is particularly interesting for the uplink of wireless communications systems. In this article, we apply the SC-SFBC concept in a multiuser multiple-input multiple-output (MU-MIMO) scenario. We introduce a novel algorithm allowing the optimization of the parameters of SC-SFBC to enable low-complexity decoding at the receiver side and to maximize the overall spectral occupancy in MU-MIMO SC-FDMA systems, and we show the good performance of the proposed MU scheme.

**Keywords:** SC-FDMA, transmit diversity, single-carrier space frequency block coding, multi-user MIMO, peak to average power ratio.

## 1. Introduction

Orthogonal frequency division multiple access (OFDMA) and OFDMA-based multi-carrier (MC) transmission schemes have undeniably become one of the main references in modern communications systems. Almost all recent communication standards rely on an OFDMA downlink air interface and implement multiple-input multiple-output (MIMO) techniques [1]. Such is the case in IEEE 802.11n for wireless local area networks, IEEE 802.16e-2005 for mobile WiMAX, Long-Term Evolution (LTE) of Universal Mobile Telecommunications System, and also in the future LTE-advanced standard.

The general acceptance of OFDMA as a good option for the downlink of recent communications systems is motivated by its well-known advantages: good spectral efficiency, good coverage, flexible dynamic frequency allocation, simple equalization at tone level [2]. Even though OFDMA is widely employed in the downlink, its use in the uplink is hampered by the high peak-to-

average power ratio (PAPR) it displays. The PAPR problem, common for all MC transmission schemes, induces numerous performance issues such as reduced power efficiency, spectral regrowth and in-band distortion when using nonlinear high power amplifiers (HPA). Many efforts were directed to efficiently alleviating the PAPR problem [3-6], but because of either some standard-compatibility issues or some practical system limitations the problem is not yet considered as completely solved [7].

While the PAPR problem, inevitable in the downlink, can be coped with by using highly linear (and thus expensive) HPAs for example, this is a much more sensitive issue in the uplink. Mobile users strive for good coverage and good autonomy handsets, but do not neglect the associated costs. On one hand, backing-off the uplink signal level to the linear region of the HPA would reduce the coverage. On the other hand, using highly linear HPAs would increase the handset cost. For these reasons, the uplink physical layer of LTE [8] was chosen to be a precoded OFDMA air interface, called single-carrier frequency division multiple access (SC-FDMA). The precoder is a discrete fourier

\* Correspondence: c.ciochina@fr.merco.mee.com  
Wireless Communications Systems, Mitsubishi Electric R&D Centre Europe,  
Rennes, France

transform (DFT), which restores the low envelope fluctuations of single-carrier (SC) systems [9,10]. But SC-FDMA may lose its low-PAPR property in MIMO systems if no precaution is taken.

A PAPR-preserving transmit diversity technique for SC-FDMA, coined single-carrier space frequency block coding (SC-SFBC), was already introduced for user with two transmit antennas in [11], and some extensions to users with four transmit antennas were also presented in a single-user (SU)-MIMO scenario. SC-SFBC makes use of an innovative subcarrier mapping to apply the well-known Alamouti scheme [12] in an SC-FDMA system at subcarrier level in the frequency domain without degrading the PAPR.

The aim of this article is to extend the SC-SFBC concept to the multiuser (MU)-MIMO SC-FDMA scenario, by notably taking into account the specific issues of users with different spectral allocations. After the introduction in Section 1, we will briefly review the principles of SC-SFBC in Section 2. Section 3 states the problems raised by employing SC-SFBC in an MU-MIMO transmission and explains how the parameters of SC-SFBC can be optimized to allow MU transmission and also gives an algorithm of spectral occupancy optimization. Some results are presented in Section 4. Finally, Section 5 presents the conclusions of this study.

## 2. Low-PAPR MIMO techniques for SC-FDMA

Future mobile terminals will be equipped with typically two or even four transmit antennas and several radiofrequency chains. It is therefore natural to try and apply MIMO techniques for the uplink of future wireless communications systems, since terminals will be able to use their multiple transmit antennas to increase throughput, increase link quality, mitigate interference or perform a trade-off among the above [13]. More particularly, transmit diversity techniques are interesting to be applied for users at cell edge experiencing poor propagation conditions; for high mobility users not having access to reliable channel state information (CSI); or, more generally, for the transmission of sensitive data such as control information, where a good reliability is required despite the absence of feedback information.

### 2.1 Transmit diversity in SC-FDMA

SC-FDMA combines an SC signal with an OFDMA-like multiple access to achieve both the low PAPR specific to SC signals and the flexible dynamic frequency allocation specific to OFDMA. In its frequency domain implementation [8], SC-FDMA is a precoded OFDMA transmission scheme, where precoding is done by means of a DFT. As in all cyclic-prefixed OFDMA-based

systems, the system in the frequency domain [before passing through the inverse DFT (IDFT)] experiences an equivalent diagonal channel [14]. Therefore, it is after the DFT precoding that a transmit diversity precoding module must be inserted, in order to be able to correctly apply at subcarrier level space-time (ST) or space-frequency (SF) block codes (BC) that were originally designed for narrowband channels.

In Figure 1, at time  $t$ , data block vector  $\mathbf{x}^{(t)} = [x_0^{(t)} \dots x_{M-1}^{(t)}]$  composed of  $M$  modulation symbols  $x_k^{(t)}$  ( $k = 0 \dots M - 1$ ), e.g., quadrature phase shift keying (QPSK) symbols, is DFT-precoded by means of a  $M$ -sized DFT  $\mathbf{F}_M$ .  $M$ -sized vectors  $\mathbf{S}^{(t)}$  thus obtained undergo ST/SF precoding, resulting in  $M$ -sized vectors  $\mathbf{s}^{\text{Tx}_n(t)}$ ,  $n = 0 \dots N_{\text{Tx}} - 1$ , where  $N_{\text{Tx}}$  is the number of transmit antennas. These vectors are then mapped on  $M$  out of  $N$  inputs of the IDFT  $\mathbf{F}_N^H$  (the superscript  $(\cdot)^H$  stands for the Hermitian of a vector or matrix) according to the subcarrier mapping strategy to be transmitted on antennas  $\text{Tx}_n$ . In this article, we will consider that the mapping matrix  $\mathbf{Q}$  corresponds to localized subcarrier mapping. To combat the effect of the frequency selective channel, a cyclic prefix (CP) is inserted in front of each  $N$ -sized block thus obtained.

Classically applying transmit diversity in SC-FDMA systems raises several issues. Let us suppose that  $N_{\text{Tx}} = 2$ . The choice of an Alamouti code [12] is natural for a scenario with two transmit antennas, since it has full rate, full diversity and is easily decodable.

If trying to apply an Alamouti-based STBC (i.e., precoding in the time domain between time-consecutive frequency samples  $s_{k_0}^{(t_0)}$  and  $s_{k_0}^{(t_1=t_0+1)}$  carried by the same  $k_0$  th subcarrier), then we coarsen the granularity of the system. All transmission bursts would need to be composed of an even number of SC-FDMA symbols, which is difficult to guarantee into practice.

In the LTE-Advanced system for example, for certain formats of the uplink control channel, only five SC-FDMA symbols will be present in a slot [15]. This renders impossible the use of STBC. The advantage of STBC is that it preserves the SC-like PAPR of SC-FDMA.

On the other hand, if trying to apply an Alamouti-based SFBC (i.e., precoding in the frequency domain between frequency-adjacent frequency samples  $s_{k_0}^{(t_0)}$  and  $s_{k_1=k_0+1}^{(t_0)}$  belonging to the same SC-FDMA symbol), this would increase the PAPR of the resulting signal, as shown in [11,16]. The main advantage of SC-FDMA, which is its SC-like PAPR, would be lost. The advantage of SFBC is its flexibility, since it can be applied to any number of SC-FDMA symbols in a transmission burst.

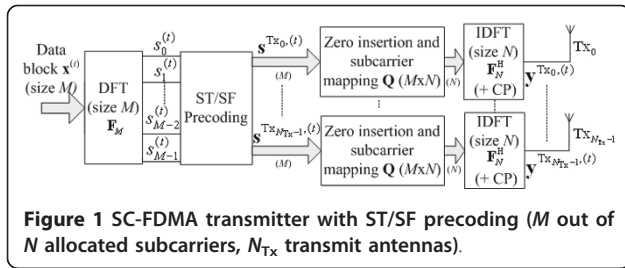

**Figure 1** SC-FDMA transmitter with ST/SF precoding ( $M$  out of  $N$  allocated subcarriers,  $N_{Tx}$  transmit antennas).

### 2.2 The principles of SC-SFBC

SC-SFBC [11] is an innovative mapping scheme, suitable for implementing transmit diversity in SC-FDMA systems. It conserves both the flexibility of SFBC and the good PAPR of STBC. Just as classical SFBC, SC-SFBC performs Alamouti-based precoding in the frequency domain between frequency samples belonging to the same SC-FDMA symbol. The main difference with respect to classical SFBC is that SC-SFBC precodes between non-adjacent frequency samples  $s_{k_0}^{(t_0)}$  and  $s_{k_1=(p-1-k_0) \bmod M}^{(t_0)}$  where  $M$  is the number of subcarriers allocated to a user and  $p$  is an even integer satisfying  $0 \leq p < M - 1$ . In the following, the superscripts  $(t_0)$  will be omitted. SC-SFBC is constructed such as the original SC signal is transmitted on the first transmit antenna  $Tx_0$  and a transformed signal is transmitted on the second transmit antenna  $Tx_1$ :

$$\begin{cases} \mathbf{s}^{Tx_0} = \mathbf{s} \\ \mathbf{s}^{Tx_1} = SC_M^p(\mathbf{s}) \end{cases} \quad (1)$$

The  $SC_M^p(\mathbf{s})$  operation consists in taking the complex conjugates of vector  $\mathbf{s}$  in reversed order, applying alternative sign changes and then cyclically shifting down its elements by  $p$  positions. This is depicted in Figure 2. Alamouti-precoded pairs appear on couples of non-adjacent subcarriers  $(k_0, k_1)$  with:

$$k_1 = (p - 1 - k_0) \bmod M. \quad (2)$$

Intuitively, based on the properties of the Fourier transform, the frequency domain  $SC_M^p$  operation (consisting in spectrum reversal, alternative sign changes and frequency domain shifting by  $p$  positions) does not

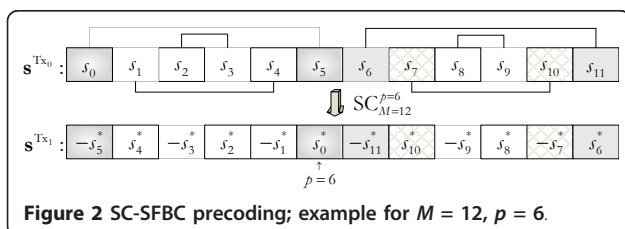

**Figure 2** SC-SFBC precoding; example for  $M = 12$ ,  $p = 6$ .

impact on the SC nature of the signal, since neither spectrum shuffling nor amplitude modifications of the spectral components are performed. Indeed, in the time domain, the  $SC_M^p$  operation is equivalent to complex conjugation and phase shifts, but no amplitude modification is performed. It is fully proven in [11], both analytically and by means of simulation, that SC-SFBC does not increase the PAPR of the resulting signal and that the signal  $\mathbf{y}^{Tx_1}$  on the second transmit antenna  $Tx_1$  has the same PAPR as the original SC-FDMA signal  $\mathbf{y}^{Tx_0}$ , both for localized and for distributed subcarrier mapping. In the case of localized subcarrier mapping for example, in [11] it is proven that

$$|\gamma_n^{Tx_1}| = |\gamma_{n+N/2}^{Tx_0}|, \quad n = 0 \dots N - 1 \quad (3)$$

Equation 3 formally proves that  $\mathbf{y}^{Tx_1}$  has strictly the same PAPR as the original SC-FDMA signal  $\mathbf{y}^{Tx_0}$ , and the simulation results are reproduced in Figure 3.

The maximum separation between subcarriers carrying frequency samples precoded together is  $\max(p, M - p)$  and is thus controlled by the parameter  $p$ . Distant subcarriers might experience different or even uncorrelated channel realizations, which generates some interference within the Alamouti-precoded pair. Some slight performance degradation can therefore occur on very selective channels and/or when the precoding distance is rather large. The optimum value of  $p$ , minimizing the maximum distance between subcarriers carrying Alamouti pairs, is the even integer closest to  $M/2$ :

$$p_{opt} = 2 \cdot \text{floor}(M/4) \quad (4)$$

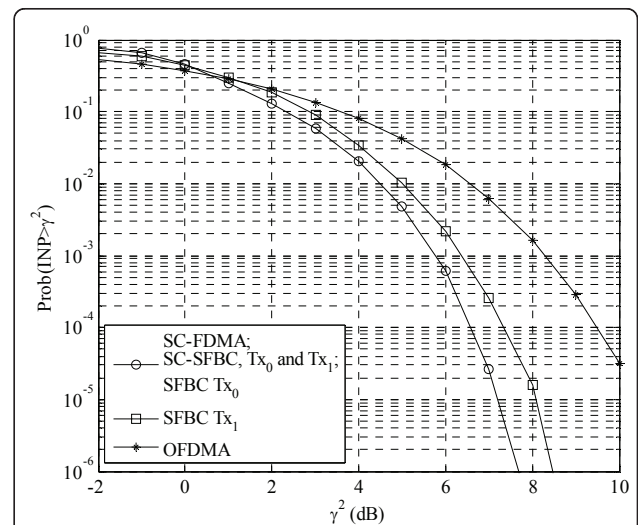

**Figure 3** The distribution of the instantaneous normalized power (INP): SC-FDMA, SC-SFBC, classical SFBC, OFDMA.

SC-SFBC can benefit from low-complexity frequency-domain decoding. Indeed, couples of subcarriers  $(k_0, k_1)$  carrying Alamouti pairs can be identified and separately decoded. To minimize the impact of the interference created within the Alamouti pair by precoding onto distant subcarriers, minimum mean square error (MMSE) is employed instead of the maximum ratio combining usually employed in Alamouti decoding. MMSE decoding remains low-complexity (inversion of one order-2 matrix for each of the  $M/2$  Alamouti pairs in one SC-FDMA symbol).

### 3. Multi-user SC-SFBC

So far, the study reviewed in the previous section concentrated on transmit diversity techniques for SU-MIMO transmission, where each mobile station (MS) uses its transmit antennas to improve the performance at a given throughput, making use of the available spatial diversity. Let us now introduce the principles of SC-SFBC in a MU-MIMO scenario.

#### 3.1 Extending SC-SFBC to MU transmission

We consider that several users, each user having an MS equipped with two transmit antennas, are managed by the same base station (BS). The BS tries to optimally map the uplink signals of these users in a given limited bandwidth. Each such user implements SC-SFBC as a transmit diversity scheme. According to the desired throughput, to the capabilities of each MS and to the corresponding channel quality, the scheduler at the BS will decide the modulation and coding scheme (MCS) and the spectral allocation of each user. To optimize the spectral occupancy and increase the throughput, it is interesting to allow some spectral reuse between users having either the same or different overlapping allocated bandwidths.

Let us assume that the scheduler allows two users ( $MS_0$  and  $MS_1$ ) to share some (or all) of the subcarriers allocated to each user. Each user is employing transmit diversity techniques, e.g., SC-SFBC, and there is some spectral overlapping between users. More clearly, the MU-MIMO scheme used here combines spatial multiplexing with SC-SFBC. This is depicted in Figure 4. The MU-MIMO channel has  $N_{TX} = N_{TX} + N_{TX} = 4$  transmit antennas (two antennas for each of the two user). At least two receive antennas are needed at the BS to separate the two users.

At the scheduler, the number of subcarriers  $M_i$ , as well as the starting position  $n_i$  of the portion of spectrum allocated to each  $MS_i$ , is computed. When SC-SFBC is used, Equation 4 shows that, to minimize the maximum distance between subcarriers coded together, the best strategy is to employ  $SC_{M/2}^{p=2\lfloor M/4 \rfloor}$ . For

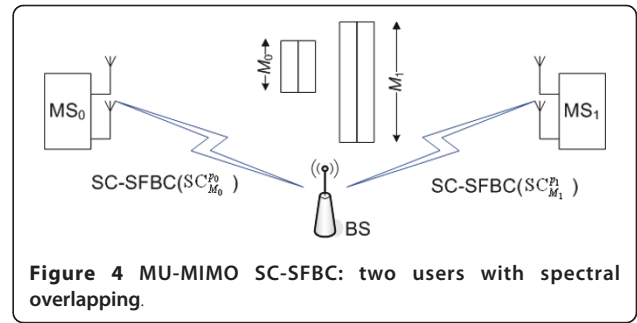

simplification, let us consider in the following that  $M$  is a multiple of 4 and thus  $p_{opt} = M/2$ . In an MU-MIMO context, double SC-SFBC might have some pairing incompatibility problems. Indeed, let us analyze the situation depicted in Figure 5, where  $MS_0$  is allocated  $M_0 = 8$  subcarriers and  $MS_1$  is allocated  $M_1 = 12$  subcarriers. The portions of spectrum occupied by the two MSs start with the same spectral position  $n_0 = n_1 = 0$ , which means that the first occupied subcarrier by each MS is the one with index 0, denoted as  $f_0$  in Figure 5.

Therefore,  $MS_0$  should use  $SC_{4}^4$  and  $MS_1$  should use  $SC_{6}^6$ . Subcarriers with indexes  $(k_0, k_1)$  obtained by applying Equation 2 contain Alamouti pairs. Each MS uses its optimum  $p$  parameter, respectively,  $p_0 = 4$  and  $p_1 = 6$  in this example. On the fifth occupied subcarrier  $f_4$  for example,  $MS_0$  transmits frequency samples  $s_4$  and  $-s_7^*$  onto its two transmit antennas, respectively. Next,  $f_4$  is paired with  $f_7$ , onto which  $MS_0$  transmits frequency samples  $s_7$  and  $s_4^*$ , respectively. On the same subcarrier  $f_4$ ,  $MS_1$  transmits frequency samples  $s'_4$  and  $-s'_{11}$ , respectively, onto

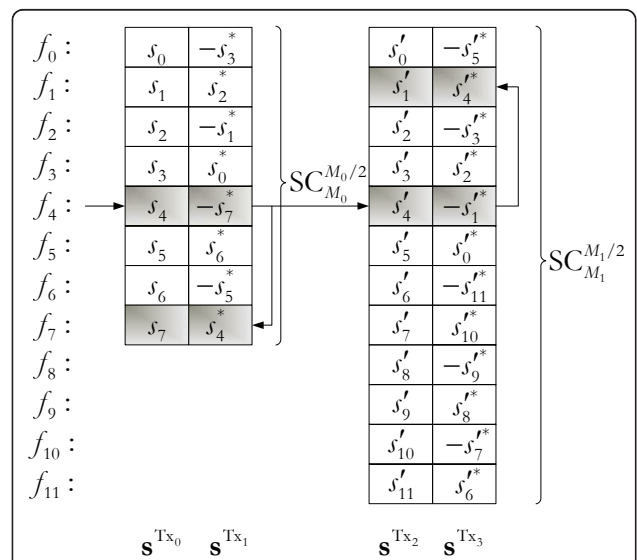

**Figure 5** MU double SC-SFBC with incompatible pairing of subcarriers; example for  $M_0 = 8$ ,  $p_0 = 4$ ,  $M_1 = 12$ ,  $p_1 = 6$ .

its two transmit antennas. Since  $MS_1$  uses  $SC_{12}^6$ ,  $f_4$  is paired with  $f_1$ . As a result, the pairing of subcarriers is not compatible between  $MS_0$  and  $MS_1$ . Because of this incompatibility, this structure does not correspond to a double SC-SFBC construction and the conventional MMSE simplified detector cannot be employed anymore.

A joint MMSE detection over all the bandwidth containing cross-codes subcarriers is necessary in this case. For the example in Figure 5, this would involve inverting a matrix of order  $M_0 + M_1 = 20$  instead of two matrices of order 4 and two matrices of order 2, as it would have been the case if the two MS were correctly aligned to form double Alamouti pairs on the overlapping subcarriers, and simple Alamouti pairs on the remaining subcarriers. The problem becomes even more complex when three or more users have overlapping subcarriers. This complexity issue is a real problem in practice. Since the number of subcarriers allocated to each user is variable, and the number of users having partially overlapping transmission bandwidths with one another may be more than 2, the receiver must be dimensioned for the worst-case scenario and should be able to invert matrices of rank hundreds or thousands. For an LTE transmission in the 5-MHz bandwidth (using 300 data carriers for example), the receiver should be dimensioned so as to be able to invert matrices of order 600.

### 3.2 Parameter optimization

To show how this incompatibility problem can be avoided, let us notice that any  $SC_M^p$  operation can be seen as the concatenation of  $SC_p^0$  and  $SC_{M-p}^0$  operations, applied onto the first  $p$  and, respectively, the last  $M - p$  samples of the input vector:

$$SC_M^p([s_0 \dots s_{M-1}]) = [SC_p^0([s_0 \dots s_{p-1}]), SC_{M-p}^0([s_p \dots s_{M-1}])] \quad (5)$$

This is a direct result of the very structure of SC-SFBC. Indeed, in the example in Figure 2, we notice that  $\mathbf{s}^{Tx_1} = SC_{12}^6(\mathbf{s}^{Tx_0})$  while the first (respectively last) six frequency samples of  $\mathbf{s}^{Tx_1}$  respect the relationship:

$$\begin{cases} [s_0^{Tx_1} \dots s_{p-1}^{Tx_1}] = SC_p^0([s_0^{Tx_0} \dots s_{p-1}^{Tx_0}]) \\ [s_p^{Tx_1} \dots s_{M-1}^{Tx_1}] = SC_{M-p}^0([s_p^{Tx_0} \dots s_{M-1}^{Tx_0}]) \end{cases} \quad (6)$$

Let us denote the number of subcarriers simultaneously used by two MSs by  $M_{\text{overlap}}$ . To avoid any pairing incompatibility, the two MSs need to transmit the same symbol structure over the overlapping spectral portion. Based on the property stated above, when the two MSs have strictly different spectral allocations, the only valid option is to chose  $p$  parameters  $p_i$  and

spectrum positions  $n_i$  such that the overlapping portion has a structure based on  $SC_{M_{\text{overlap}}}^0$ . While an optimization of parameter  $p$  has no direct impact on the allocated set of subcarriers, an optimization of the spectrum positions  $n_i$  limits the flexibility of the frequency scheduler.

The case where the two MSs have the same number of allocated subcarriers  $M_0 = M_1$  and share the same bandwidth is trivial since no pairing incompatibility arises. Pairs of subcarriers  $(k_0, k_1)$  carrying double Alamouti pairs can be identified and low-complexity MMSE decoding can be applied (involving  $M/2$  order-4 matrix inversions). We only treat here of the case of different spectral allocation  $M_0 \neq M_1$ , let us assume for example  $M_0 < M_1$ . The case of users with the same number of allocated subcarriers  $M_0 = M_1$  but different allocated bands  $n_0 \neq n_1$  can be treated in a similar manner.

For  $n_0 = n_1$ , a solution is given in Figure 6. We need to impose  $MS_0$  to use  $SC_{M_0}^{p_0=0}$  and  $MS_1$  to use  $SC_{M_1}^{p_1=M_0}$ . The  $SC_{M_1}^{p_1=M_0}$  can be seen as the concatenation of two SC-like operations

- $SC_{M_0}^0$  to match the configuration of  $MS_0$ ; on this part of the spectrum, double SC-SFBC transmission can thus be employed;
- The remaining  $SC_{M_1-M_0}^0$  corresponds to a simple SC-SFBC transmission and keeps an overall SC-type signal to be transmitted by  $MS_1$ .

Hence, it is no longer possible to use a default value for the  $p$  parameter for all the system (highest even integer inferior to half of the respective number of allocated

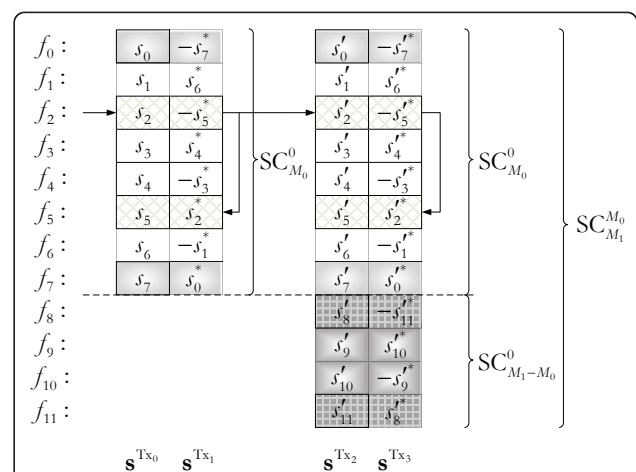

**Figure 6** MU double SC-SFBC  $M_0 < M_1$ , an example for  $M_0 = 8$ ,  $M_1 = 12$ ,  $p_0 = 0$ ,  $p_1 = 8$ ,  $n_0 = n_1$ .

subcarriers), but double SC-SFBC structure is kept at the expense of a modification of the  $p$  parameter, i.e., some performance degradation as the maximum distance between subcarriers that are jointly precoded is increased. But, complexity is strongly reduced: only two matrices of order 4 and two matrices of order 2 need to be inverted during MMSE decoding for the example in Figure 6, while for the structure in Figure 5 an inversion of an order-20 matrix was required. It should also be noted that additional signaling is necessary to indicate the values of  $p$  to be used by each MS in this case.

An alternative solution for the case when the spectral bands allocated to the two MSs do not have the same spectral starting position is to decompose  $SC_{M_1}^{p_1}$  into  $SC_{p_1}^0$  and  $SC_{M_1-p_1}^0$ , and to allocate  $MS_0$  in the middle of the bandwidth occupied by  $SC_{p_1}^0$  if  $p_1 > M_0$ , or in the middle of the bandwidth occupied by  $SC_{M_1-p_1}^0$  otherwise. An example is depicted in Figure 7. Nevertheless, this might lead to a modified double SC-SFBC (there is a sign inversion within the double SC-FDMA pair on antenna  $Tx_3$ ) which needs to be taken into account at the receiver, without any performance loss. In both cases depicted in Figures 6 and 7, it is possible to allow double SC-SFBC; thanks to an optimization of parameter  $p$  only. No constraint is introduced in the frequency scheduler to optimize  $n_0$  and  $n_1$ .

### 3.3 Optimization of spectral occupancy

Let us now extend the particular cases treated in the previous section to a general framework where a BS manages several MS, let their number be  $N_{users}$ . We

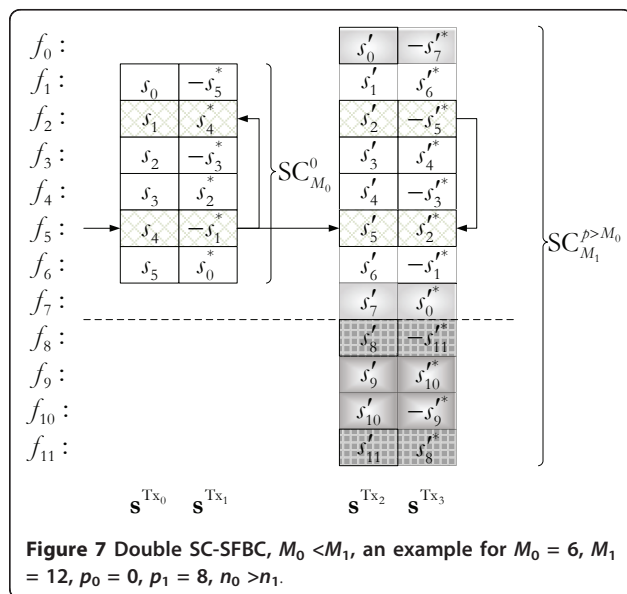

propose here to optimize not only the parameter  $p$  but also the spectrum positions  $n_i$  so as to allow using double SC-SFBC by several terminals having overlapping spectrum allocations.

Depending on the needs and capabilities of uplink communication of each MS, the BS determines the number of subcarriers  $M_i$  allocated to each  $MS_i$ ,  $i = 0 \dots N_{users} - 1$ . Each MS is equipped of at least two transmit antennas. Each MS uses SC-FDMA with SC-SFBC transmit diversity for its uplink communication. Our purpose is to schedule these  $N_{users}$  MSs in such a manner that the occupied bandwidth is minimized and the overall throughput is optimized. The couple  $(p_i, n_i)$ , representing the  $p$  parameter and the first occupied subcarrier, needs to be determined for each  $MS_i$ .

The main idea behind the solution is to determine two groups of users, A and B. Spectral bands allocated to each user do not overlap inside of each group, but each user of each group can have overlapping subcarriers with a maximum of two users from the other group, such as onto the overlapping subcarriers double Alamouti pairs are formed.

Let subcarrier numbering starting at  $n_0^A = 0$ ;  $n_0^B$  can be either null or take another positive value.  $n^A$  and  $n^B$  are auxiliary parameters indicating the index of the first available subcarrier in groups A and B, respectively. We suppose that BS tries to map  $N_{users}$  MSs in a bandwidth that is as compact as possible (alternatively, it could have one given available bandwidth and would try to map as many users as possible; algorithm still stands but the STOP condition needs to be modified). The algorithm presented in the Annex (additional file 1) tries to minimize the number of subcarriers allocated to only one single MS to improve the overall spectral efficiency, while forming double SC-SFBC pairs on the subcarriers simultaneously allocated to two MSs to ensure low-complexity decoding. The principle of this algorithm is to use the fact that the SC operator can be decomposed as shown in Section 3.2, with the purpose of optimizing the spectral occupancy. Users are treated one at a time, and at each step the treated user is allocated a  $p$  parameter such as to share a maximum number of subcarriers with the previous user by forming "double Alamouti" pairs. STOP condition is attained when all the users have been scheduled.

Let us apply the algorithm in Annex (additional file 1) for a BS that schedules four MSs with different communication needs, and decides to allocate them, respectively,  $M_0 = 12$ ,  $M_1 = 8$ ,  $M_2 = 8$ ,  $M_3 = 4$  subcarriers

$$\text{START: } i = 0, n_0^A = 0, n_0^B = 0, N_{users} = 4$$

$$n^A = n_0^A = 0, n^B = n_0^A + n_0^B = 0$$

$i < N_{\text{users}}$ ? YES:

Select  $MS_0$ , determine  $M_0 = 12$

$n^A < n^B$ ? NO:

$n^A = n^B$ ? YES:

Select  $MS_1$ , determine  $M_1 = 8$

$M_0 = M_1$ ? NO:

$n_0 = n_1 = 0, p_0 = M_1 = 8, p_1 = 0$

$n^A = 12, n^B = 8, i = 2$

$i < N_{\text{users}}$ ? YES:

Select  $MS_2$ , determine  $M_2 = 8$

$n^A < n^B$ ? NO:

$n^A = n^B$ ? NO:

$M_2 > n^A - n^B$ ? YES

$n_2 = n^B = 8, p_2 = n^A - n^B = 4$

$n^B = 16, i = 3$

$i < N_{\text{users}}$ ? YES:

Select  $MS_3$ , determine  $M_3 = 4$

$n^A < n^B$ ? YES:

$n^A = n_0^A$ ? NO:

$M_3 > n^B - n^A$ ? NO:

$n_4 = 12, p_4 = 0$

$i = 4$

$i < N_{\text{users}}$ ? NO:

**STOP.**

The results are depicted in Figure 8. In a similar manner, all the cases depicted in Figures 6 and 7 can be deduced based on this algorithm.

Of course, this scheduling strategy directly constrains the frequency scheduler. However, it should be understood that transmit diversity is mainly intended for terminals that cannot benefit from any close-loop processing as CSI-based frequency scheduling. In other words, no frequency scheduling gain can be achieved in this case and the constraint imposed on the frequency scheduler is only a specific ordering of each allocated spectrum, given predetermined spectrum sizes  $M_i$ .

#### 4. Simulation results

Let us consider an SC-FDMA system with  $N = 512$  subcarriers, among which 300 are active data carriers, to fit a bandwidth of 5 MHz. To retrieve frequency diversity, groups of 12 SC-FDMA symbols with QPSK signal mapping are encoded together with a rate-1/2 turbo code using the LTE interleaving pattern [8]. A CP with a length of 36 samples is employed. We consider an uncorrelated Vehicular A MIMO channel with six taps and a maximum delay spread of 2.51  $\mu\text{s}$  [17]. Localized subcarrier mapping and ideal channel estimation are assumed. We employ MMSE detection, with successive interference cancelling to reduce the inter-user interference in the MU-MIMO case.

From the discussion in Section 2.2, we can deduce that not using the individual optimum  $p$  parameter (4) for the schemes proposed in Section 3 might lead to some performance degradation. Let us first evaluate the severity of this degradation in the SU case. Let us consider that  $M = 120$  localized subcarriers (covering around five times the channel coherence bandwidth) are allocated to a user traveling at 3 kmph, and benefiting from perfect channel estimation and MMSE decoding. Figure 9 analyzes how the choice of parameter  $p$  influences the performance of SC-SFBC. Performance is evaluated in terms of frame error rate (FER).  $p = 60$  and  $p = 30$ , corresponding to  $p = M/2$  and  $p = M/4$ , respectively, have similar performance. Employing  $p = 16$  and  $p = 0$  leads to a degradation of 0.2 and 0.4 dB, respectively. For vehicular A channel and for the present simulation parameters, the correlation bandwidth  $B_{\text{coh}}$  corresponds to approximately 26 subcarriers. In these conditions, when employing  $p = 60$  and  $p = 30$ , about 43% of the Alamouti pairs (26 out of 60 pairs) are situated on subcarriers having highly correlated fading. This percentage drops to 35 and 21% when choosing  $p = 16$  and  $p = 0$ , respectively. This is a worst-case scenario, since users needing to employ transmit diversity are usually in bad propagation conditions and are allocated rather small numbers of subcarriers. We can thus conclude that the associated performance degradation due to optimizing the  $p$  parameter as proposed in Sections 3.2 and 3.3 is negligible in practice.

Let us now investigate the performance of the MU double SC-SFBC scheme with low decoding complexity proposed in Section 2.2 with respect to the MU SC-SFBC scheme with incompatible subcarrier pairing (e.g., like in Figure 5). We consider that  $M_0 = 60$  and, respectively,  $M_1 = 20$  localized subcarriers are allocated to two users and four receive antennas are present at the BS. For the MU double SC-SFBC scheme, the  $p$  parameters

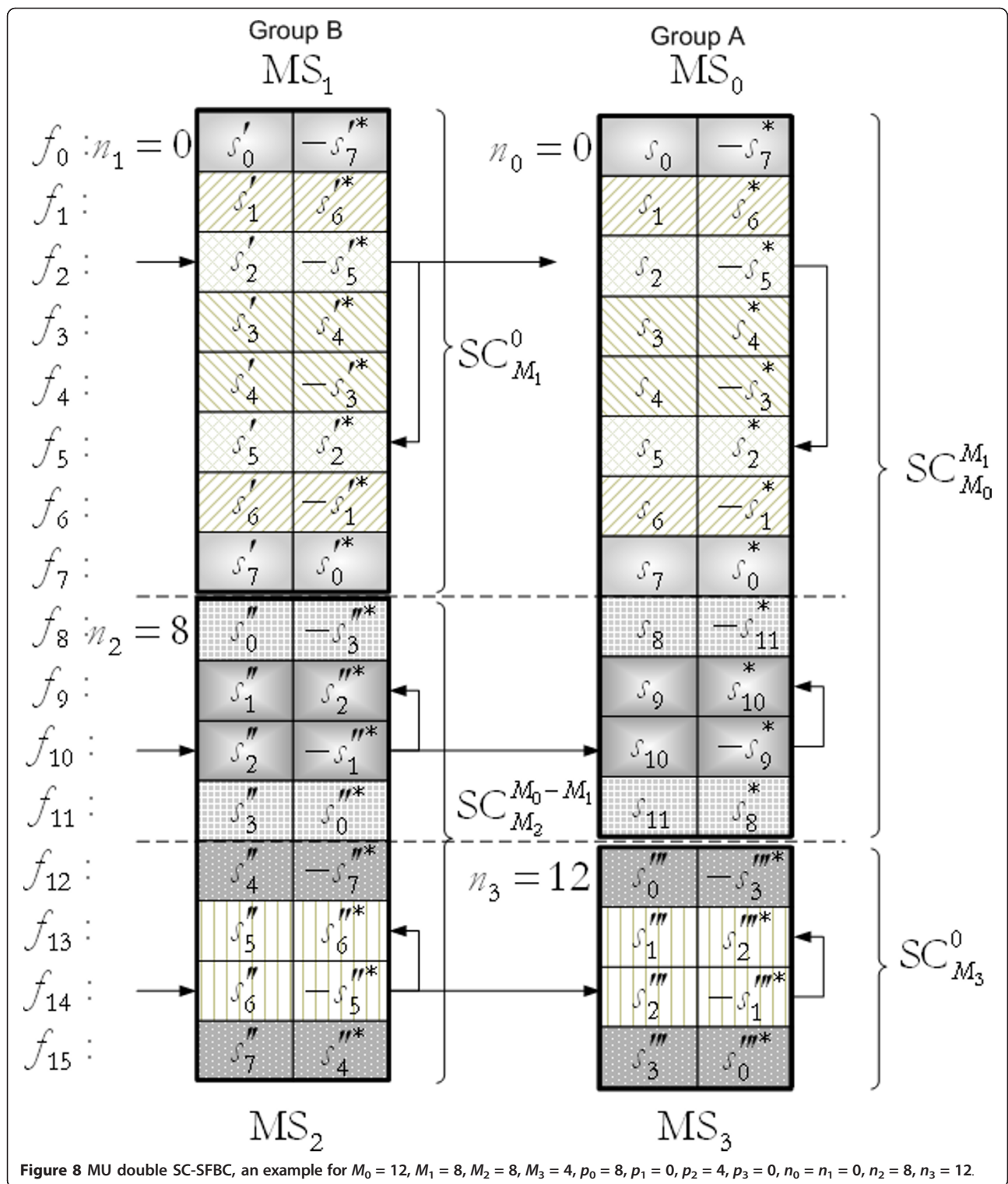



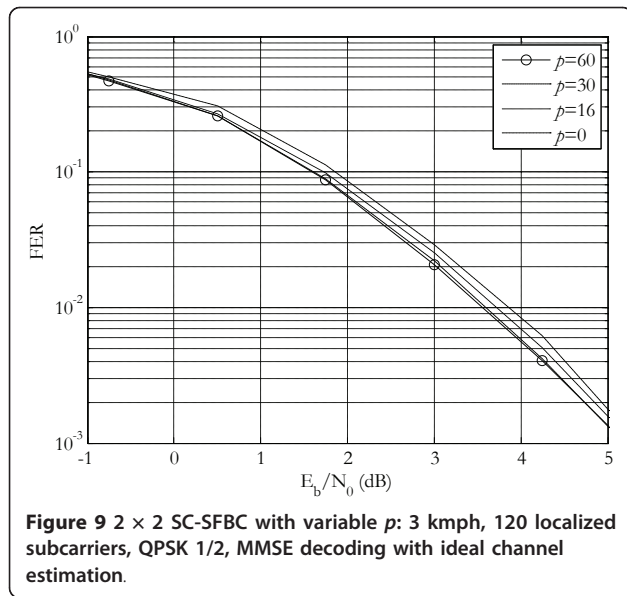

are not optimal from a user-egoistic point of view, since they were optimized with the aim of reducing the decoding complexity. As shown in Figure 9 and 9 discussed in the previous paragraph, this might lead to some performance degradation.

The results of this evaluation are presented in Figure 10. In both cases,  $MS_0$  performs better than  $MS_1$  because of the higher frequency diversity (more allocated subcarriers), and of lower inter-user interference profile ( $MS_0$  only suffers from inter-user interference within 1/5 of its spectrum, while  $MS_1$  is interfered within the totality of its spectrum). At a target FER of  $2 \times 10^{-2}$ , for  $MS_0$ , both schemes exhibit similar performance. For  $MS_1$ , the MU SC-SFBC with incompatible

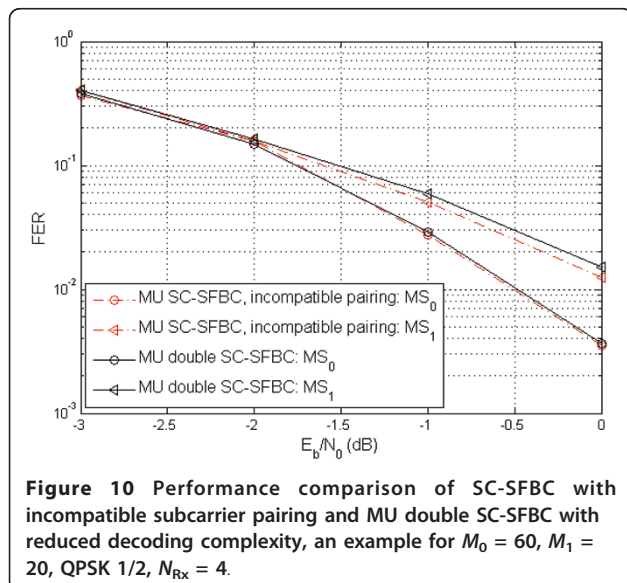

subcarrier pairing has a slight advantage (0.14 dB), due to the use of user-egoistic optimum  $p$  parameters, as explained in Figure 9. Nevertheless, the performance difference between MU SC-SFBC with incompatible pairing and MU double SC-SFBC with low decoding complexity is negligible. This is in favor of the latter scheme, who exhibits a much lower complexity decoding.

## 5. Conclusions and future work

SC-FDMA imposed itself as a good option for the uplink air interface of wireless communications systems. In order to preserve its main advantage, which consists in the low envelope variations it exhibits, special care needs to be taken when applying MIMO techniques in SC-FDMA systems. SC-SFBC has already been proposed as a robust SU-MIMO transmit diversity scheme compatible with SC-FDMA. In this article, we extended the principles of SC-SFBC to MU-MIMO.

A novel algorithm allowing the optimization of the parameters of SC-SFBC to enable low-complexity decoding at the receiver side and to maximize the overall spectral occupancy in MU-MIMO SC-FDMA systems is introduced. We show the good performance of the proposed algorithm. Future study will concentrate in further investigation of the proposed algorithm, including throughput evaluations for several MCSs.

## Additional material

**Additional file 1: Annex A.** PDF file containing Annex A.

## Acknowledgements

Part of the study presented in this article was developed within the framework of the European collaborative research project "Advanced Radio Interface Technologies for 4G SysTems" (ARTIST 4G). The authors would also like to thank Mr. Xiaoran Jiang for his helpful input concerning the evaluation of the techniques presented in this article.

## Competing interests

The authors declare that they have no competing interests.

Received: 15 October 2010 Accepted: 8 September 2011

Published: 8 September 2011

## References

1. WWR Forum (ed.), in *Technologies for the Wireless Future*, vol. 3. (John Wiley, 2008)
2. H Sari, G Karam, I Jeanclaude, Frequency-domain equalization of mobile radio and terrestrial broadcast channels, in *GLOBECOM'94* (December 1994)
3. J Tellado, *Multicarrier Modulation with Low Peak to Average Power Applications to xDSL and Broadband Wireless* (Kluwer Academic Publishers, Boston, 2000)
4. Z Li, X-G Xia, PAPR reduction for repetition space-time-frequency coded MIMO-OFDM systems using Chu sequences. *IEEE Trans Wireless Commun.* 7(4), 1195–1202 (2008)
5. T Jiang, Y Wu, An overview: peak-to-average power ratio reduction techniques for OFDM signals. *IEEE Trans Broadcast.* 54(2), 257–268 (2008)

6. H Ochai, H Imai, Performance of the deliberate clipping with adaptive symbol selection for strictly band-limited OFDM systems. *IEEE J Sel Areas Commun.* **18**(11), 2270–2277 (2000). doi:10.1109/49.895032
7. C Ciochina, F Buda, H Sari, An analysis of OFDM peak power reduction techniques for WIMAX systems, in *ICC'06*, (Istanbul, Turkey, June 2006)
8. 3rd Generation Partnership Project; Technical Specification Group Radio Access Network; Evolved Universal Terrestrial Radio Access (E-UTRA), "Physical Channels and Modulation (Release 9)". 3GPP TS 36.211 V9.1.0 (March 2010)
9. HG Myung, J Lim, DJ Goodman, Single carrier FDMA for uplink wireless transmission. *IEEE Veh Technol Mag.* **3**(1), 30–38 (2006)
10. HG Myung, J Lim, DJ Goodman, Peak-to-average power ratio of single carrier FDMA signals with pulse shaping, in *17th Annual IEEE International Symposium on Personal, Indoor and Mobile Radio Communications (PIMRC'06)*, (Helsinki, Finland, September 2006)
11. C Ciochina, D Castelain, D Mottier, H Sari, New PAPR-preserving mapping methods for single-carrier FDMA with space-frequency block codes. *IEEE Trans Wirel Commun.* **8**(10), 5176–5186 (2009)
12. SM Alamouti, A simple transmit diversity technique for wireless communications. *IEEE J Sel Areas Commun.* **16**(8), 1451–1458 (1998). doi:10.1109/49.730453
13. D Tse, P Viswanath, *Fundamentals of Wireless Communication* (Cambridge University Press, Cambridge, 2005)
14. Z Wang, G Giannakis, Wireless multicarrier communications. *Signal Process Mag IEEE.* **17**(3), 29–48 (2000). doi:10.1109/79.841722
15. 3rd Generation Partnership Project; Technical Specification Group Radio Access Network; Evolved Universal Terrestrial Radio Access (E-UTRA), "Multiplexing and Channel Coding (Release 10)". 3GPP TS 36.212 V10.1.0 (March 2011)
16. 3rd Generation Partnership Project, RAN1, Performance Evaluations of STBC/SFBC Schemes in E-UTRA Uplink, R1-063179, Alcatel
17. 3GPP TR 25.996 V7.0.0 (2007-06), Spatial channel model for Multiple Input Multiple Output (MIMO) simulations

doi:10.1186/1687-6180-2011-54

**Cite this article as:** Ciochina et al.: Low PAPR space frequency block coding for multiuser MIMO SC-FDMA systems: specific issues for users with different spectral allocations. *EURASIP Journal on Advances in Signal Processing* 2011 **2011**:54.

**Submit your manuscript to a SpringerOpen<sup>®</sup> journal and benefit from:**

- Convenient online submission
- Rigorous peer review
- Immediate publication on acceptance
- Open access: articles freely available online
- High visibility within the field
- Retaining the copyright to your article

---

Submit your next manuscript at ► [springeropen.com](http://springeropen.com)

---