

## Natural variants of human p85 $\alpha$ phosphoinositide 3-kinase in severe insulin resistance: a novel variant with impaired insulin-stimulated lipid kinase activity

K. C. R. Baynes<sup>1</sup>, C. A. Beeton<sup>2</sup>, G. Panayotou<sup>3</sup>, R. Stein<sup>3</sup>, M. Soos<sup>1</sup>, T. Hansen<sup>4</sup>, H. Simpson<sup>5</sup>, S. O'Rahilly<sup>1</sup>, P. R. Shepherd<sup>2</sup>, J. P. Whitehead<sup>1</sup>

<sup>1</sup> Departments of Medicine and Clinical Biochemistry, University of Cambridge, UK

<sup>2</sup> Department of Biochemistry, University College London, UK

<sup>3</sup> Ludwig Institute of Cancer Research, London, UK

<sup>4</sup> Steno Diabetes Center, Gentofte, Denmark

<sup>5</sup> Diabetes Centre, Royal Berkshire Hospital, Reading, UK

### Abstract

**Aims/hypothesis.** Phosphoinositide 3-kinase (PI 3K) plays a central part in the mediation of insulin-stimulated glucose disposal. No genetic studies of this enzyme in human syndromes of severe insulin resistance have been previously reported.

**Methods.** Phosphoinositide 3-kinase p85 $\alpha$  regulatory subunit cDNA was examined in 20 subjects with syndromes of severe insulin resistance by single strand conformational polymorphism and restriction fragment length polymorphism analyses. Insulin-stimulated phosphoinositide 3-kinase activity and recruitment into phosphotyrosine complexes of variants of p85 $\alpha$  were studied in transiently transfected HEK293 cells. Phosphopeptide binding characteristics of wild-type and mutant p85 $\alpha$ -GST fusion proteins were examined by surface plasmon resonance.

**Results.** The common p85 $\alpha$  variant, Met<sup>326</sup>Ile, was identified in 9 of the 20 subjects. Functional studies of the Met<sup>326</sup>Ile variant showed it to have equivalent insulin-stimulated lipid kinase activity and phosphotyrosine recruitment as wild-type p85 $\alpha$ . A novel heterozygous mutation, Arg<sup>409</sup>Gln, was detected in

one subject. Within the proband's family, carriers of the mutation had a higher median fasting plasma insulin (218 pmol/l) compared with wild-type relatives (72 mol/l) ( $n = 8$  subjects,  $p = 0.06$ ). The Arg<sup>409</sup>Gln p85 $\alpha$  subunit was associated with lower insulin-stimulated phosphoinositide 3-kinase activity compared with wild-type (mean reduction 15%,  $p < 0.05$ ,  $n = 5$ ). The recruitment of Arg<sup>409</sup>Gln p85 $\alpha$  into phosphotyrosine complexes was not significantly impaired. GST fusion proteins of wild-type and mutant p85 $\alpha$  showed identical binding to phosphopeptides in surface plasmon resonance studies.

**Conclusion/interpretation.** Mutations in p85 $\alpha$  are uncommon in subjects with syndromes of severe insulin resistance. The Met<sup>326</sup>Ile p85 $\alpha$  variant appears to have no functional effect on the insulin-stimulated phosphoinositide 3-kinase activity. The impaired phosphoinositide 3-kinase activity of the Arg<sup>409</sup>Gln mutant suggests that it could contribute to the insulin resistance seen in this family. [Diabetologia (2000) 43: 321–331]

**Keywords** Genetics, insulin signalling, phosphatidylinositol 3-kinase.

Received: 21 July 1999 and in revised form: 19 October 1999

**Corresponding author:** Professor S. O'Rahilly, Department of Medicine, Box 157, Level 5, Addenbrooke's Hospital, Hills Road, Cambridge CB2 2QR, UK

**Abbreviations:** EBVL, Epstein-Barr virus transformed lymphocytes; GST, glutathione S-transferase; IPTG, isopropyl- $\beta$ -D-thiogalactoside; PDK-1, phosphatidylinositol [3, 4, 5] P3-dependent kinase-1; PI 3K phosphoinositide 3-kinase; PI P3, phosphatidylinositol [3,4,5]phosphate; PKB, protein kinase B; SH2 domain, homology domain; SSCP, single-strand conformational polymorphism; TLC thin layer chromatography.

Severe insulin resistance is found in a heterogeneous group of uncommon disorders characterised by acanthosis nigricans, impaired glucose tolerance or diabetes mellitus and in women, features of hyperandrogenism such as oligomenorrhoea and hirsutism [1–3]. The mechanisms underlying severe insulin resistance in human disease remain poorly understood, but mutations in the insulin receptor gene or autoantibodies to the insulin receptor are responsible in only a small minority of cases [4–6]. The increasing knowledge of the complexity of intracellular insulin signalling path-

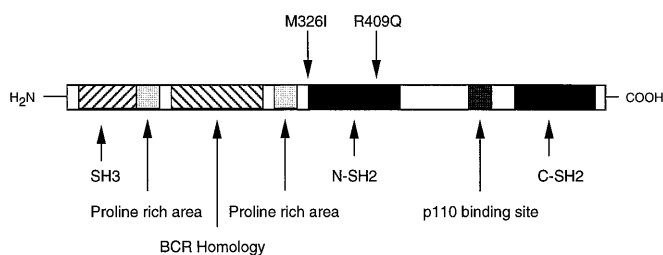

**Fig. 1.** Domain structure of p85 $\alpha$  regulatory subunit of PI 3K showing the positions of the two variants identified

ways has opened up a large number of candidate genes potentially responsible for cases of genetically determined insulin resistance [7].

Insulin activates the intrinsic tyrosine kinase of its receptor which phosphorylates YXXM amino acid sequence motifs in a number of proteins, primarily the insulin receptor substrates (IRS) [8, 9] which then recruit a variety of proteins through their SH2 domains. The class I<sub>a</sub> phosphoinositide 3-kinases (PI 3K) are recruited in this way [10]. Insulin-stimulated activation of PI 3K results in the generation of phosphorylated lipid products from membrane-bound substrates which act as intracellular second messengers [11]. Activation of PI 3K precedes a number of important signalling events including stimulation of phosphatidylinositol [3,4,5] P<sub>3</sub>-dependent kinase-1 (PDK-1) dependent kinase-1 (PDK-1), protein kinase B, p70 s6 kinase, GLUT4 vesicle translocation to the plasma membrane and inhibition of glycogen synthase kinase-3. Moreover, PI 3K is necessary, if not sufficient, for the insulin-stimulated increase in glucose uptake and glycogen synthesis in insulin-sensitive tissues [12, 13].

The involvement of PI 3K in mediating downstream metabolic effects of insulin led us to postulate that defects in insulin-stimulated PI 3K activity might explain severe insulin resistance in some people. To date, no systematic study of the PI 3K genes in the syndromes of severe insulin resistance has been undertaken. Impaired PI 3K activation in cultured dermal fibroblasts in a small number of subjects with the pseudoacromegalic phenotype of severe insulin resistance has, however, recently been described [14–16] indicating the possibility that primary defects in PI 3K genes could be found.

The class I<sub>a</sub> 3K activated by insulin consist of a 110000 M<sub>r</sub> catalytic subunit (p110) tightly linked to an 85000 M<sub>r</sub> regulatory subunit (p85) [11]. A number of forms of the regulatory subunit exist, but all of these contain two SH2 domains, which mediate the recruitment of the PI 3K heterodimer to signalling complexes containing tyrosine phosphorylated YXXM motifs. Two highly homologous full-length class I<sub>a</sub> PI 3K regulatory subunit genes have been identified, these being p85 $\alpha$  and p85 $\beta$  [17–21]. Both p85 $\alpha$  and p85 $\beta$  contain two C-terminal region SH2

domains which are separated by the catalytic subunit binding domain (Fig. 1). Also common to both isoforms and situated in the N-terminal region are an SH3 domain, a BCR (Breakpoint-Cluster Region) homology domain and two short proline-rich domains (Fig. 1). A third regulatory subunit gene termed p55 $\gamma$  has recently been identified which encodes a shorter gene product lacking these N-terminal domains [22]. Additionally, two major splice variants of the p85 $\alpha$  gene have been described which result in truncated proteins also lacking the N-terminal domains [23–26]. We have previously established that p85 $\alpha$  and its splice variants are all expressed and regulated by insulin in human muscle which is a major site of insulin-mediated glucose disposal [27]. The importance of these splice variants has been shown recently in a p85 $\alpha$  gene knockout mouse in which the full-length p85 $\alpha$  gene product is deleted, but the splice variants are still expressed [28]. These p85 $\alpha$  knockout mice show major changes in their profile of glucose metabolism indicating that p85 $\alpha$  and its splice variants play a crucial part in insulin-mediated glucose disposal in vivo. Although sequence variants of p85 $\alpha$  have been described in studies of human cohorts, no functional studies of natural variants have been reported. We describe here the results of a search for genetic variation in the p85 $\alpha$  regulatory subunit in subjects with severe insulin resistance and the biochemical analysis of two amino acid variants of this protein.

## Materials and methods

**Clinical subjects.** Subjects had all been referred to Addenbrooke's hospital with a diagnosis of severe insulin resistance (Table 1) which was confirmed, where possible, by pronounced hyperinsulinaemia during a standard 75-g oral glucose tolerance test. Measurements of specific insulin were made by a chemiluminescent immunoassay (Access Immunoassay System, Beckman Instruments, High Wycombe, UK).

**Total RNA extraction and cDNA synthesis.** Dermal fibroblasts derived from subject skin biopsies were grown to confluence in DMEM (Sigma, Poole, UK) containing 10% fetal bovine serum, 25 mol/l glucose, 2 mol/l glutamine, 100 units penicillin ml and 100 mg streptomycin ml and lysed directly in TRIzol reagent (GibcoBRL, Paisley, UK). Lymphocytes derived from subject wholeblood samples were transformed using Epstein-Barr virus to create independent cell lines (EBVLS). These were grown in RPMI-1640 medium (Sigma) containing additions as above until visibly clumping. Cells in suspension were then pelleted by centrifugation at 2000 g for 5 min and resuspended in TRIzol reagent. Total RNA from subject relatives was extracted from buffy coat preparations of venous blood samples. Total RNA was reverse transcribed into cDNA using random hexamer oligonucleotides as primers (Promega, Southampton, UK).

**Polymerase chain reaction.** We amplified 200 ng cDNA by the polymerase chain reaction (PCR) method using 1 unit of *Taq* DNA polymerase (Biolone, London, UK), 0.3  $\mu$ mol/l primers

**Table 1.** Clinical characteristics of study subjects

Number	Diagnosis	Sex	Fasting insulin pmol/l	2-h insulin pmol/l	Fasting glucose mmol/l
1	PA	F	287	2,555	6.6
2	PA	F	106	NA	14.8
3	PA	M	6,540	NA	6.2
4	VIR DM	F	NA	NA	NA
5	Type A	F	90	6,830	5.4
6	Type A	F	736	NA	5.9
7	Lipoatrophy	M	5,944	8,080	9.9
8	Type A	F	101	6,237	5.4
9	Type A	M	449	3,515	5.4
10	Type A	F	267	1,473	4.2
11	Type A	F	248	NA	4.4
12	Type A	F	525	1,009	4.4
13	Type A	F	202	4,354	5.8
14	Type A	F	259	3,505	4.5
15	Lipoatrophy	F	500	2,000	4.9
16	Type A	F	357	1,330	7.9
17	Type A	F	180	NA	11.6
18	Type A	F	212	2,268	4.7
19	Type A	F	703	NA	4.6
20	Lipoatrophy	F	310	3,105	6.0

PA	Pseudo-acromegaly
Type A	Type A insulin resistance syndrome
VIR DM	Very insulin resistant Type II diabetes mellitus
Lipoatrophy	Lipodystrophic syndromes
NA	Data not available

(Genosys, Cambridge, UK) and 0.75 or 1.5 mol/l using 40 cycles of denaturing 94°C × 60 s, annealing 52°C or 54°C × 60 s and extending 72°C × 60 s with a final extension at 72°C for 7 min.

**Single-strand conformational polymorphism (SSCP) and heteroduplex analysis.** We amplified p85α cDNA by PCR in 12 overlapping segments of approximately 250 bp by using primer pairs specific to the human p85α cDNA sequence (Table 2). Radiolabelled PCR products were generated by including 0.04–0.07 MBq α<sup>32</sup>P dCTP (Amersham Pharmacia Biotech, Little Chalfont, UK) in the PCR mixture. These were diluted in formamide loading buffer to a uniform concentration and run on non-denaturing gels under two conditions: firstly, mutation detection enhancement (MDE) gel (Flowgen, Ashby-de-la-Zouch, UK) run at room temperature at 8 W for 6 h and secondly, 6% polyacrylamide gel run at 80°C at 40 W for 4 h. Gels were dried, exposed to autoradiography film (Biomax MR, Kodak, Anachem, Luton, UK) for 24–48 h and then developed.

**DNA sequencing.** Polymerase chain reaction products of interest were generated using one biotinylated primer and the PCR product isolated using streptavidin-coated magnetic beads (Dynabeads, Dynal, UK). Single-strand DNA was then sequenced directly using <sup>35</sup>S-labelled nucleotides by Sanger dideoxy methodology (USB Sequenase 2.0 kit, Amersham Pharmacia Biotech).

**Expression vector construction.** Plasmids containing the wild-type bovine p85α coding sequence alone (pBS.p85α and pcDNA3.p85α) or with an N-terminal GST tag (pGEX2T.p85α) were a gift from M.D. Waterfield. A C-terminal Myc epitope tag was inserted into p85α by PCR. The Arg<sup>409</sup>Gln (R409Q) variant was introduced into pBS.p85αMyc by PCR

of a *Xho* I/*Sal* I fragment and then sub-cloned into the pGEX2T.p85α GST-fusion protein expression vector (Amersham Pharmacia Biotech) through an *Nsi* I fragment. The Met<sup>326</sup>Ile variant was introduced into pGEX2T.p85α by PCR of a *Pst* I/*Sal* I fragment and then sub-cloned into pcDNA3.p85αMyc. The plasmid pcDNA3.p85αMycR409Q was generated by sub-cloning a *Bam*H I/*Xba* I fragment from pBS.p85αMycR409Q into the pcDNA3 backbone (Invitrogen, Leek, The Netherlands). The human p110α coding sequence (a gift from M.D. Waterfield) was inserted into pcDNA3 and a C-terminal FLAG epitope tag was added using PCR (pcDNA3.p110α.FLAG).

**Transient transfection.** We grew HEK293 cells to 60% confluence in 60 cm<sup>2</sup> dishes and transfected with calcium phosphate using 8 μg pcDNA3.p85αMyc and 6 μg pcDNA3.p110αFLAG or empty vector. Transfection efficiencies by this technique were estimated by transfection with pTracer (Invitrogen) a vector which results in overexpression of green fluorescent protein. Cell counting using a fluorescence microscope (Carl Zeiss microscope, Welwyn Garden City, UK) showed that transfection efficiencies ranged from 20–25%. Cells were harvested 36 h after transfection. All cells were serum-starved for 16 h and then stimulated with 100 nmol/l insulin for 10 min. Cells were lysed in 1 ml PI 3K lysis buffer (137 mmol/l NaCl, 2.7 mmol/l KCl MgCl<sub>2</sub>, 0.5 mmol/l Na<sub>3</sub>VO<sub>4</sub>, 1% v/v Nonidet P40, 10% w/v glycerol, 20 mmol/l TRIS pH 8.0 at 4°C, 21 μmol/l leupeptin, 0.2 mmol phenylmethylsulphonyl fluoride). Insoluble material was removed by centrifugation at 10000 g for 5 min.

**Immunoprecipitation and immunoblotting.** Cleared cell lysate (160 μl) was incubated at 4°C for 90 min on a rotating wheel with 1.5 μl of mouse monoclonal antiphosphotyrosine antibody (PY99, Santa Cruz Biotechnology, Autogen-Biocal, Calne, UK). Then 2.5 mg of rehydrated Protein A-agarose beads (Sigma) were added, incubated for a further 60 min and washed three times. Protein samples were boiled for 5 min in Laemmli sample buffer, resolved by SDS-PAGE and transferred to Immobilon-P polyvinylidene fluoride membranes (Millipore, Bedford, Ma., USA) by semi-dry blotting. The membranes were blocked in 1% bovine serum albumin (BSA) in phosphate-buffered saline (PBS)-Tween 0.1% v/v (Sigma) incubated with primary antibody, washed with PBS-Tween, incubated with secondary antibody and finally washed in PBS-Tween. The Myc epitope was detected with 9E10 primary antibody (a gift from G. Evan) and I<sup>125</sup>-labelled secondary antibody, the membranes were exposed to a phosphorimager screen overnight and quantified using a Fujix BAS 2000 phosphorimager (Raytek Scientific, Sheffield, UK). The FLAG epitope was detected with polyclonal primary antibody (Santa Cruz Biotechnology) and horseradish peroxidase-linked secondary antibody and enhanced chemiluminescence reagent (Amersham Pharmacia Biotech), then membranes were exposed to autoradiography film and bands were quantified.

**Phosphoinositide 3-kinase assays.** The technique for the measurement of PI 3K activity was adapted from a previously published technique [29]. Immunoprecipitates from 160 μl cleared cell lysate were collected and washed three times in PI 3K lysis buffer, two times in buffer 2 (0.5 mol/l LiCl, 0.1 mol/l TRIS-HCl pH 8.0 at 4°C), once in buffer 3 (0.15 mol/l NaCl, 1 mol/l EDTA, 10 mol/l TRIS-HCl pH 7.6 at 4°C) and once in buffer 4 (20 mol/l HEPES, 1 mol/l dithiothreitol, 5 mol/l MgCl<sub>2</sub> pH 7.6 at 4°C). The immunoprecipitates were then resuspended in 40 μl kinase assay buffer (20 mol/l β-glycerophosphate pH

**Table 2.** Sequences of oligonucleotide primers used for PCR amplification of human p85 $\alpha$  PI 3K cDNA for SSCP

Primer pair	Forward primer 5' to 3'	Reverse primer 5' to 3'	PCR product size (bp)
1	CAACCAGGCTCAACTGTTGC	ACCAGCCAATTTCTTCAGGC	205
2	GCTCTGGATTCAAGTGATGG	TGATAAGAAGAGGGCGGGGC	286
3	GATCTTGCAGAGCAGTTTGC	GGTAAGTCCAGGAGATAGCG	232
4	GTGCACGTTTTGGCTGACGC	TGCTGGAGGTTTGAGAGAGC	231
5	TCATCAGTATTGGCTTACGC	GTTATTCATACCGTTGTTGGC	273
6	CCTCTAAACCACAAAACC	GGTTAATGGGTCAGAGAAGC	269
7	CTCTTACACTAAGGAAAGGGG	TGACAACCTGATCCTGTTGG	206
8	CTCTAGCTCAGTATAATCCC	AAATGCTTCAATAGCTGTCC	226
9	GAAGAATATACCCGCACATCC	ATTTCTCGATACTCAGCTGC	284
10	GACAGTAGAAGAAGATTGGAAG	TGCTTCCAACATTCCATGTC	267
11	GAAGACCAATATTCAGTGGTGG	CACCAGTTCTTTCAGAGAGC	275
12	AACTGGCTATGGCTTTGCCG	GATGGCTTCGTTTCTGCAGC	259
p55 $\alpha$	ATGTACAATACTGTTTGGAAATATGG	GTTATTCATACCGTTGTTGGC	171

7.2 at 4°C, 5 mol/l sodium pyrophosphate, 30 mmol/l NaCl, 1 mmol/l dithiothreitol), 20  $\mu$ l lipid mix [freshly prepared by vortexing a 1.67 mg aliquot of phosphatidylinositol (Lipid Products, South Nutfield, UK) in 560  $\mu$ l kinase assay buffer containing 1% w/v cholic acid] and added and samples incubated at 37°C for 5 min 0.02 MBq <sup>32</sup>P-ATP in 40  $\mu$ l reaction mix (3 mol/l cold ATP, 7.6 mol/l MgCl<sub>2</sub> in kinase assay buffer) were then added and incubated for a further 15 min before terminating the lipid kinase reaction with 0.45 ml CHCl<sub>3</sub>/MeOH 1:2 v/v. The phospholipids were extracted by two washes in CHCl<sub>3</sub>/0.1 mol/l HCl 1:1 v/v, dried in a vacuum centrifuge at 1000 g for 30 min and the residue dissolved in 35  $\mu$ l CHCl<sub>3</sub>/MeOH/0.1 mol/l HCl 200:100:1 v/v and separated by thin layer chromatography (TLC) as described elsewhere [30]. The dried TLC plates were exposed on a phosphorimager screen for 30 min and the amount of phosphatidylinositol 3-phosphate produced was quantified using a Fujix BAS 2000 phosphorimager.

**Glutathione-S-transferase-fusion protein expression.** Glutathione-S-transferase (GST)-fusion proteins were induced by isopropyl- $\beta$ -D-thiogalactoside (IPTG) in *E. coli* and purified from bacterial lysates by glutathione sepharose columns (Amersham Pharmacia Biotech).

**Phosphopeptide binding studies.** A biotinylated-tyrosine-phosphorylated 17mer peptide corresponding to the PDGF  $\beta$  receptor Y751 SH2 domain binding site (DMSKDESV-D\*YVPMLDMK) was immobilised on an avidin-coated surface plasmon resonance biosensor chip (BIAcore, Uppsala, Sweden). Binding of the p85 $\alpha$  GST fusion proteins to this biosensor surface was completed by the addition of either monophosphorylated non-biotinylated 17mer peptide or a diphosphorylated non-biotinylated 19mer peptide (GG\*YMDMSKDESSVD\*YVPML) containing 2 YXXM motifs corresponding to the Y740 and Y751 SH2 domain binding sites of the PDGF  $\beta$  receptor [31].

## Results

**Molecular scanning.** The p85 $\alpha$  coding sequence was examined in 20 subjects (17 female, 3 male) with features of severe insulin resistance using reverse-transcription-PCR-single-strand conformational polymorphism (RT-PCR-SSCP) and heteroduplex analy-

sis. All SSCP and heteroduplex variants were further studied by direct nucleotide sequencing. Three variants were detected in this cohort which on DNA sequencing showed two silent polymorphisms (TAC $\rightarrow$ TAT at nucleotide 261 in seven subjects, ATT $\rightarrow$ ATC at nucleotide 663 in two subjects) and a single-point mutation (CGG $\rightarrow$ CAG at codon 409) which resulted in a novel heterozygous missense amino acid change Arg<sup>409</sup>Gln in one person (Fig. 1). Analysis of the p55 $\alpha$  splice variant of p85 $\alpha$ , which contains a unique 32 amino acid N-terminal extension, showed no additional SSCP variants. In agreement with others we also found that all cDNA samples sequenced at amino acid residue 330 coded for Asp suggesting that there is an error in the published sequence of p85 $\alpha$  [32]. Also of note was the absence of mutations in the p85 $\alpha$  gene in the pseudoacromegalic patients whom we have previously reported to have impaired insulin-stimulated PI 3K activity in their cultured dermal fibroblasts [15].

The subject carrying the Arg<sup>409</sup>Gln missense variant was a 23-year-old Caucasian female with features of the Type A syndrome who began to develop hirsutism, oligomenorrhoea and impaired glucose tolerance in her late teenage years (subject 14 in Table 1). She had a history of acanthosis nigricans since infancy. Biochemical evaluation during 2-h 75-g OGTT showed increased plasma specific insulin both fasting 259 pmol/l (95% reference range < 80 pmol/l) and at 2 h 3505 pmol/l with corresponding plasma glucoses 4.5 and 10.3 mmol/l. This subject had previously been studied for the presence of insulin receptor gene mutations and none were found.

**Family and population genetic studies.** Because the Arg<sup>409</sup>Gln variant causes the loss of an *Msp I* restriction site, available members of the proband's family were genotyped by restriction fragment length polymorphism (RFLP) analysis and evaluated biochemically by fasting plasma insulin and glucose measurements. Genotype results obtained from RT-PCR of

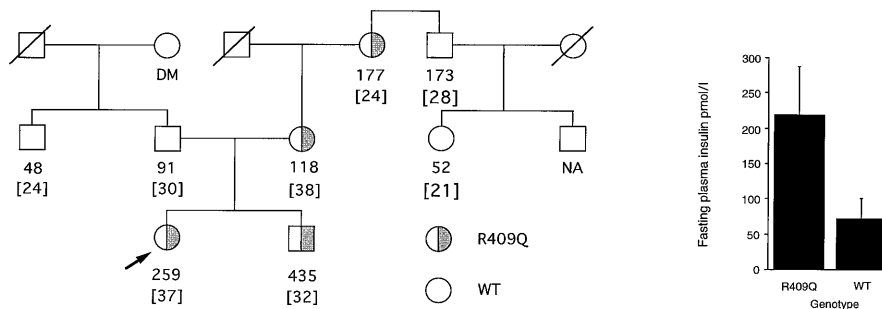

**Fig. 2.** Family tree of Arg<sup>409</sup>Gln proband. Upper numerals indicate fasting insulin (pmol/l) and lower numerals body mass index [kg/m<sup>2</sup>], where information is available. DM, Type II diabetes mellitus; NA, not available. Inset graph shows median fasting insulin values  $\pm$  SEM for Arg<sup>409</sup>Gln carriers vs wild-type subjects (Arg<sup>409</sup>Gln 218 pmol/l  $\pm$  69; WT 72 pmol/l  $\pm$  29;  $p = 0.06$ , Mann-Whitney, two-tailed)

total RNA extracted from buffy coat preparations were confirmed by an independent PCR using genomic DNA and a different set of primers. The heterozygous Arg<sup>409</sup>Gln variant was inherited through the maternal line (Fig. 2). The proband's brother, who was also heterozygous for the Arg<sup>409</sup>Gln variant, was known to have had acanthosis nigricans since childhood. Individual fasting plasma insulin concentrations in all four carriers were above the normal range with a median plasma insulin in Arg<sup>409</sup>Gln heterozygotes of 218 pmol/l  $\pm$  69 ( $n = 4$ , medians  $\pm$  SEM) compared with 72 pmol/l  $\pm$  29 ( $n = 4$ ) in relatives who were wild-type at that site ( $p = 0.06$ , Mann-Whitney: two-tailed). All the relatives studied had normal fasting plasma glucose values (range 4.5–5.6 mmol/l).

The RFLP analysis of 271 Danish subjects (136 with Type II (non-insulin-dependant) diabetes mellitus, 135 non-diabetic) found no subjects carrying the Arg<sup>409</sup>Gln variant. Similarly this variant was not found in 50 non-diabetic middle-aged UK Caucasians with fasting hyperinsulinaemia (range 91–316 pmol/l) from the Isle of Ely study [33] thus confirming that this is not a common variant.

Our SSCP study did not detect the common p85 $\alpha$  polymorphism Met<sup>326</sup>Ile previously reported in a Danish cohort. A specific RFLP assay for this variant [34] showed that the Met<sup>326</sup>Ile polymorphism was present in our severe insulin-resistant cohort at an allelic frequency of 25% (30 WT alleles, 10 Met<sup>326</sup>Ile alleles) representing eight heterozygotes and one homozygote. This reflects the less than 100% sensitivity of the SSCP technique for mutation detection. Pertinently, the person heterozygous for the Arg<sup>409</sup>Gln variant did not carry the Met<sup>326</sup>Ile variant.

### Functional studies

*Effects of p85 $\alpha$  variants on insulin-stimulated PI 3K enzymatic activity.* To examine the effects of the variant p85 $\alpha$  sequences on insulin-stimulated PI 3K activity HEK293 cells were transfected with wild-type or variant Myc-tagged p85 $\alpha$  constructs and FLAG-tagged wild-type p110 $\alpha$ . Cells were stimulated with 100 nmol/l insulin for 10 min and the PI 3K enzymatic activity present in antiphosphotyrosine immunoprecipitates was measured. Insulin-stimulated PI 3K activity in antiphosphotyrosine immunoprecipitates from mock transfected cells were approximately 20% of that in cells transfected with wild-type p85 $\alpha$  and p110 $\alpha$  (data not shown). Phosphoinositide 3-kinase activity was consistently and significantly lower in Arg<sup>409</sup>Gln than in wild-type transfections (76  $\pm$  4% vs 100  $\pm$  5%,  $p < 0.01$ ,  $n = 5$  experiments) (Fig. 3). In contrast, cells transfected with the Met<sup>326</sup>Ile adaptor subunit were indistinguishable from wild type (95  $\pm$  11% vs 100  $\pm$  5%) (Fig. 3). The presence of a Myc tag on the p85 $\alpha$  constructs allowed variability in the expression of the p85 $\alpha$  variants to be taken into account. A significant difference in PI 3K activation remained after correcting the PI 3K activities for the amount of Myc tag detected in the antiphosphotyrosine immunoprecipitates by western blotting (WT 100%  $\pm$  5 vs Arg<sup>409</sup>Gln 85%  $\pm$  4,  $n = 5$ ,  $p < 0.05$ ) (Fig. 3). Correction for p85 $\alpha$  expression in the immunoprecipitates did not alter the results with the Met<sup>326</sup>Ile variant which remained similar to wild type (Fig. 3).

The major role of p85 $\alpha$  is to facilitate recruitment of p110 $\alpha$  into signalling complexes so we also analysed the amount of p110 $\alpha$ -FLAG present in the antiphosphotyrosine immunoprecipitates. This showed a similar pattern to that observed for p85 $\alpha$  with the PI 3K activity corrected for FLAG tag being significantly lower for Arg<sup>409</sup>Gln (WT 100%  $\pm$  5 vs Arg<sup>409</sup>Gln 84%  $\pm$  5,  $p < 0.05$ ; WT 100% vs, Met<sup>326</sup>Ile 114%  $\pm$  10,  $p = \text{NS}$ ; (Fig. 3).

*Effects of p85 $\alpha$  variants on intrinsic activity of PI 3K complexes.* To examine whether the variants affected the intrinsic PI 3K activity associated with the regulatory subunits HEK293 cells were cotransfected with wild-type and variant Myc-tagged p85 $\alpha$  constructs

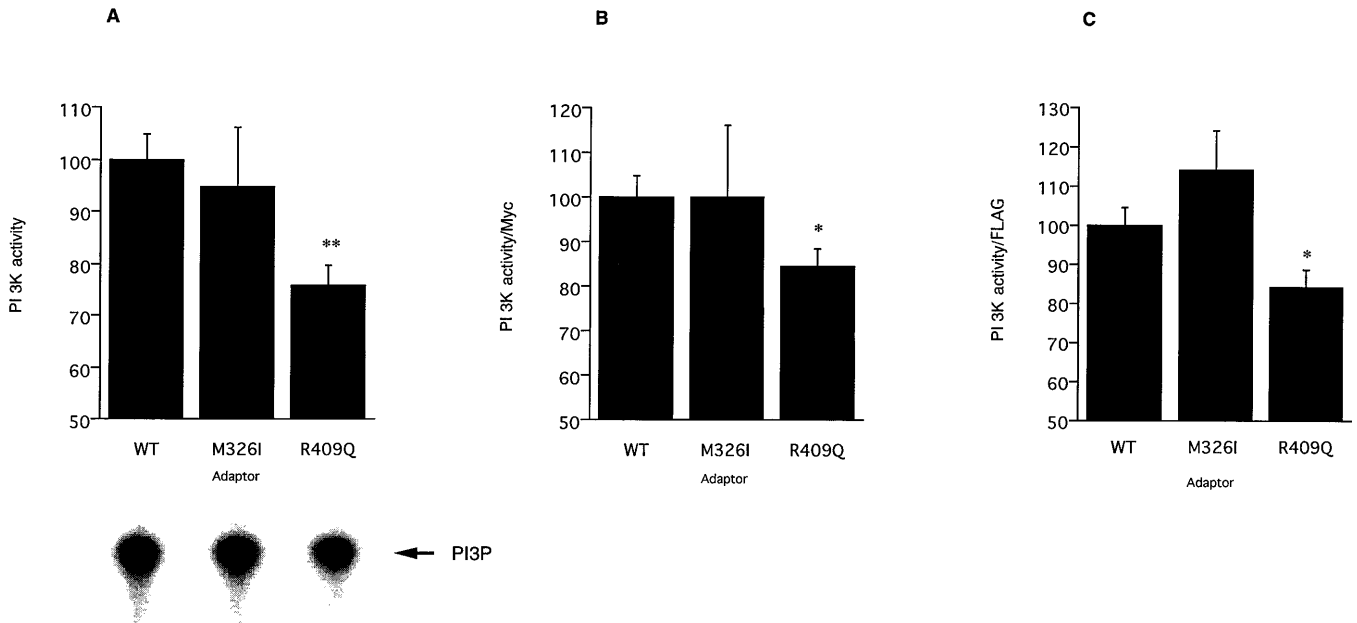

**Fig. 3 A–C.** Phosphoinositide 3-kinase activity in anti-phosphotyrosine immunoprecipitates from HEK293 cells transiently transfected with Myc-tagged p85 $\alpha$  and FLAG-tagged p110 $\alpha$  subunits of PI 3K, serum-starved overnight and then stimulated with 100 nmol/l insulin for 10 min. **A** Uncorrected PI 3K activity expressed as percentage of control. WT 100%  $\pm$  5, Met<sup>326</sup>Ile 95%  $\pm$  11, Arg<sup>409</sup>Gln 76  $\pm$  4. Data are from five independent experiments. \*\* $p$  < 0.01. **B** Phosphoinositide 3-kinase activity after correction for Myc in immunoprecipitates. WT 100%  $\pm$  5, Met<sup>326</sup>Ile 97%  $\pm$  14, Arg<sup>409</sup>Gln 85%  $\pm$  4. Data are from five independent experiments. \* $p$  < 0.05. **C** Phosphoinositide 3-kinase activity after correction for FLAG in immunoprecipitates. WT 100%  $\pm$  5, Met<sup>326</sup>Ile 114%  $\pm$  10, Arg<sup>409</sup>Gln 84%  $\pm$  5. Data are from three independent experiments. \* $p$  < 0.05

and FLAG-tagged p110 $\alpha$ . We did PI 3K assays on Myc immunoprecipitates from serum-starved cells and intrinsic activity of the expressed forms of PI 3K was calculated by correcting the PI 3K activity for the amount of Myc in the immunoprecipitates, as assessed by western blotting. These studies showed that the intrinsic activity of the Met<sup>326</sup>Ile and Arg<sup>409</sup>Gln adaptor subunits were both equivalent to wild-type p85 $\alpha$  (WT 100%  $\pm$  12, Met<sup>326</sup>Ile 101%  $\pm$  8.3, Arg<sup>409</sup>Gln 98%  $\pm$  7;  $n$  = 3,  $p$  = NS) (Fig. 4).

*Effects of p85 $\alpha$  variants on recruitment to tyrosine phosphorylated signalling intermediates.* Because amino acid residue 409 lies within the N-terminal SH2 domain of p85 $\alpha$ , variants at this position have the potential to affect binding to phosphotyrosine residues on signalling intermediates. Recruitment of transfected PI 3K subunits into antiphosphotyrosine complexes was assessed by western blotting for Myc-tagged p85 $\alpha$  and FLAG-tagged p110 $\alpha$  in antiphosp-

hotyrosine immunoprecipitates. Insulin-stimulated recruitment of both regulatory and catalytic subunits into phosphotyrosine complexes (Fig. 5). The recruitment of Met<sup>326</sup>Ile and Arg<sup>409</sup>Gln regulatory subunits was not significantly different to wild-type p85 $\alpha$  (WT 100%  $\pm$  4.7, Met<sup>326</sup>Ile 97%  $\pm$  13.8, Arg<sup>409</sup>Gln 83%  $\pm$  7.1;  $n$  = 5,  $p$  = NS) (Fig. 5). Likewise, recruitment of the FLAG-tagged p110 $\alpha$  catalytic subunit of PI 3K into phosphotyrosine complexes was similar for each of the p85 $\alpha$  variants (WT 100%  $\pm$  2.5, Met<sup>326</sup>Ile 98%  $\pm$  7, Arg<sup>409</sup>Gln 97%  $\pm$  4,  $n$  = 3,  $p$  = NS) (Fig. 5). To rule out the possibility that the reduced PI 3K activity was due to the Arg<sup>409</sup>Gln mutant associating less tightly with the catalytic subunit we calculated the ratio of FLAG tag:Myc tag in each of the anti-phosphotyrosine immunoprecipitates and found the ratio was not significantly different between the three regulatory subunit variants (data not shown) suggesting that the adaptor variants did not have altered binding to the p110 $\alpha$  catalytic subunit of PI 3K.

*In vitro binding of Arg409Gln p85 $\alpha$  to tyrosine phosphorylated proteins.* To more closely analyse the binding characteristics of the p85 $\alpha$  variant the binding of wild-type and Arg<sup>409</sup>Gln p85 $\alpha$ -GST fusion proteins was compared using a surface plasmon resonance biosensor device. The sensor surface was coated with a tyrosine phosphorylated 17mer peptide (DMSKDESVD\*YVPMLDMK) corresponding to the Y751 site of the PDGF  $\beta$  receptor. Binding of the p85 $\alpha$ -GST fusion proteins to this sensor surface was completed by the addition of either monophosphorylated 17mer peptide or a diphosphorylated 19mer peptide (GG\*YMDMSKDESSVD\*YVPML) corresponding to both the Y740 and Y751 of the PDGF  $\beta$  receptor. The half-maximum inhibitory concentrations (IC<sub>50</sub>) derived from the binding curves

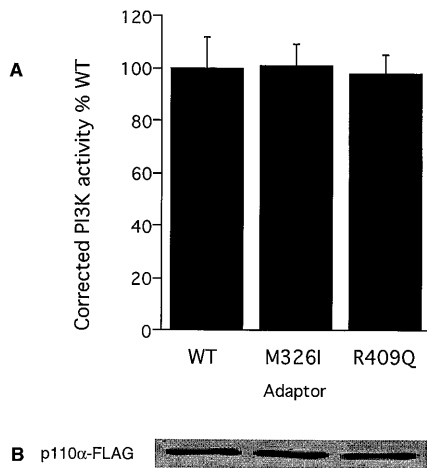

**Fig. 4A, B.** Basal PI 3K activity in anti-Myc immunoprecipitates from HEK293 cells transiently transfected with Myc-tagged p85 $\alpha$  and FLAG-tagged p110 $\alpha$  subunits of PI 3K. Cells were serum-starved for 16 h. **A** Phosphoinositide 3-kinase activity of p85 $\alpha$  variants in Myc immunoprecipitates corrected for amount of Myc present expressed as percentage of control. Data are from three independent experiments. WT 100%  $\pm$  12, Met<sup>326</sup>Ile 101%  $\pm$  8, Arg<sup>409</sup>Gln 98%  $\pm$  7,  $p = \text{NS}$ . **B** Western blot of p110 $\alpha$ -FLAG in Myc immunoprecipitates

(Fig. 6) were equivalent for both wild-type and Arg<sup>409</sup>Gln variant p85 $\alpha$  (monophosphorylated peptide IC<sub>50</sub> WT 14 nmol/l, Arg<sup>409</sup>Gln 12 nmol/l; diphosphorylated peptide IC<sub>50</sub> WT 2 nmol/l, Arg<sup>409</sup>Gln 2 nmol/l).

## Discussion

A substantial body of biochemical data attests to the importance of PI 3K in the mediation of the effects of insulin on cellular glucose metabolism [12, 13]. Evidence directly implicating dysfunction of this enzyme in human disorders of insulin action has been less readily provable. A reduction in insulin-stimulated PI 3K activity in muscle and adipose tissue from insulin-resistant subjects with Type II diabetes or obesity has been reported in a number of studies [35–37]. Impaired insulin-stimulated PI 3K activity in cultured dermal fibroblasts has been reported from subjects with the pseudoacromegalic form of severe insulin resistance suggesting the presence of an intrinsic cellular defect in the PI 3K pathway in that rare subtype of severe insulin resistance [15, 16].

Until recently there has been little genetic evidence available to confirm the action of this enzyme in the control of whole-body insulin sensitivity in mammals. It was recently reported that mice rendered null for p85 $\alpha$  are, surprisingly, more insulin sensitive than wild-type littermates and have a tendency to develop hypoglycaemia [28]. The experimental strategy employed did not, however, delete the alternatively spliced product of the p85 $\alpha$  gene,

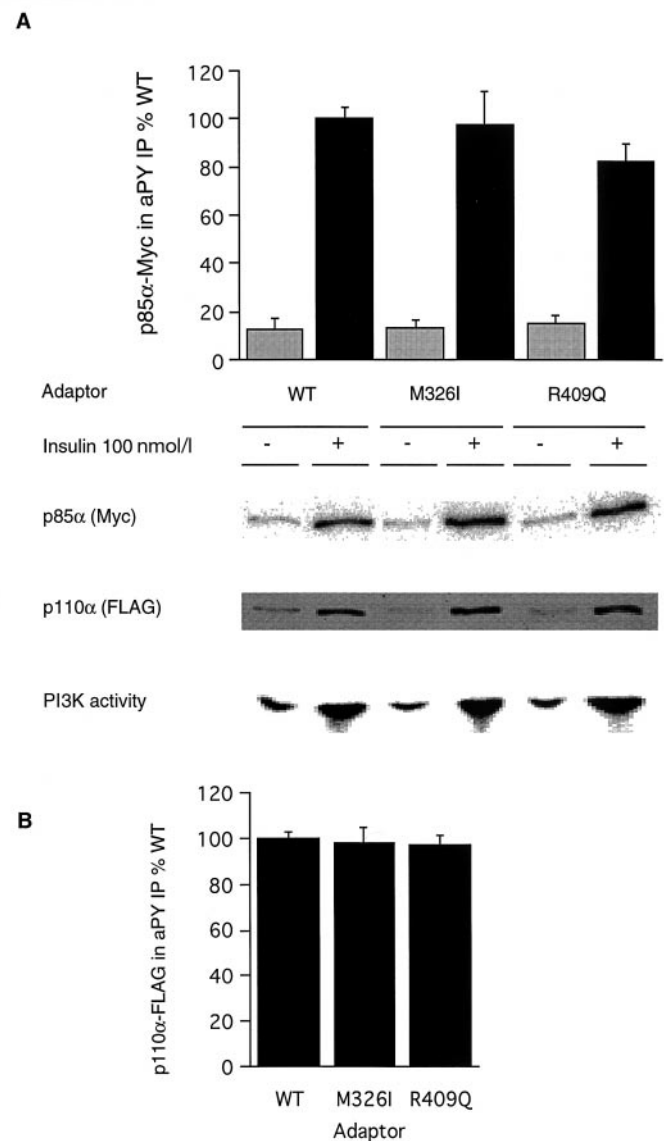
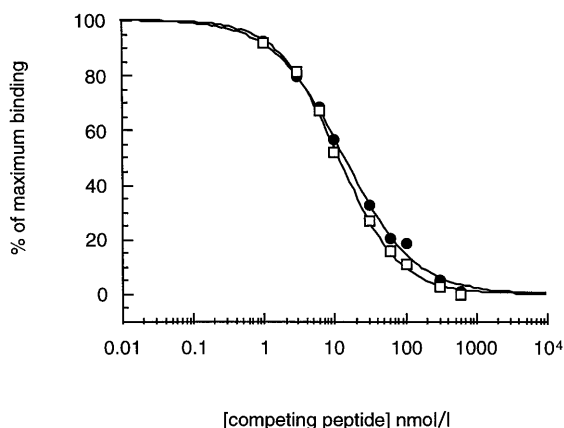

**Fig. 5A, B.** Insulin-stimulated recruitment of p85 $\alpha$  variants and p110 $\alpha$ -FLAG into phosphotyrosine complexes. HEK293 cells were transfected with Myc-tagged variant p85 $\alpha$  and FLAG-tagged, p110 $\alpha$  subunits of PI 3K, serum-starved overnight and stimulated with 100 nmol/l insulin for 10 min. **A** Amounts of Myc-tagged p85 $\alpha$  in anti-phosphotyrosine immunoprecipitates expressed as percentage of control. Data are from five independent experiments. WT 100%  $\pm$  5, Met<sup>326</sup>Ile 97%  $\pm$  14, Arg<sup>409</sup>Gln 83%  $\pm$  7,  $p = \text{NS}$ . **B** Amounts of p110 $\alpha$ -FLAG in phosphotyrosine complexes after insulin treatment. Data are from three independent experiments. WT 100%  $\pm$  3, Met<sup>326</sup>Ile 98%  $\pm$  7, Arg<sup>409</sup>Gln 97%  $\pm$  4,  $p = \text{NS}$

p55 $\alpha$ , which was noticeably up-regulated in metabolically active tissues from the knockout mice. As p55 $\alpha$  appears to be capable of coupling to p110 with similar, if not greater, efficiency than p85 $\alpha$ , this could explain the enhanced insulin sensitivity seen in these mice.

Several studies examining the p85 $\alpha$  gene for mutations in people with Type II diabetes have been re-

A



B

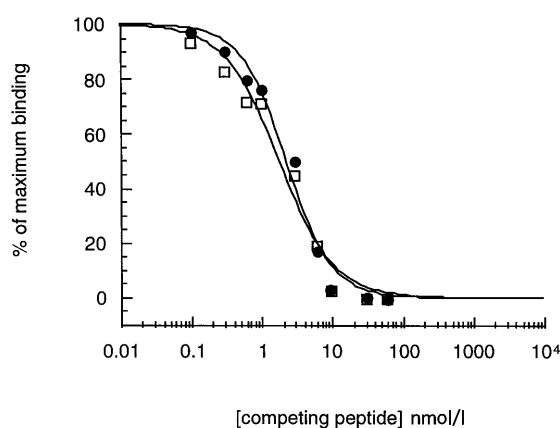

**Fig. 6A,B.** Binding studies with an optical biosensor. Biotinylated phosphopeptide DMSKDESVD\*YVPMLDMK (where \* Y indicates phosphotyrosol residues) was captured on immobilised avidin BIAcore sensor chip and binding of wild-type p85 $\alpha$  ● and Arg<sup>409</sup>Gln p85 $\alpha$  □ competed with phosphopeptides in free solution. **A** Competing with monophosphorylated peptide DMSKDESVD\*YVPMLDMK. Half-maximum inhibitory concentrations (IC<sub>50</sub>) WT p85 $\alpha$  14 nmol/l, Arg<sup>409</sup>Gln p85 $\alpha$  12 nmol/l. **B** Competing with diphosphorylated peptide GG\*YMDMSKDESSVD\*YVPML. IC<sub>50</sub> WT p85 $\alpha$  2 nmol/l, Arg<sup>409</sup>Gln p85 $\alpha$  2 nmol/l

ported. The missense polymorphism Met<sup>326</sup>Ile and two common silent polymorphisms [38], which have been previously described, were also found in our patient cohort. Association studies examining the consequences of the Met<sup>326</sup>Ile polymorphism have resulted in variable findings; one study has reported that in the homozygous form it is associated with a reduced insulin sensitivity index, glucose disappearance constant and glucose effectiveness [38] whereas another report showed no association with insulin sensitivity [32]. Two reports suggest that the Met<sup>326</sup>Ile variant is not associated with Type II diabetes [34, 38], whereas another has reported that in female Pima Indians it is

associated with a lower prevalence of Type II diabetes and a higher early phase insulin response [32]. In our group of people with severe insulin resistance we found a similar allelic frequency for the Met<sup>326</sup>Ile allele to that reported for Pima Indians (25%) [32]. The small sample size, however, and mixed racial origin of our group precludes any definite conclusions being drawn from this observation. None of the previous studies have investigated the functional activity of the Met<sup>326</sup>Ile variant. In detailed functional studies we were not able to discern any functional difference between the Met<sup>326</sup>Ile variant and wild type in insulin-stimulated PI 3K activity, association with p110 $\alpha$ , intrinsic activity of p85 $\alpha$ -p110 $\alpha$  complexes or recruitment to tyrosine phosphorylated proteins. Given the variable results of the population association studies and the consistency of our biochemical observations we conclude that this common variant is unlikely to have any major functional relevance.

In one person with severe insulin resistance, we identified the novel heterozygous missense mutation Arg<sup>409</sup>Gln. We have established by the study of two separate European populations that this is a rare variant. The possibility that the Arg<sup>409</sup>Gln mutation could have functional relevance is suggested by its location in the N-terminal SH2 domain. Recent studies have shown that the N-terminal SH2 domain has the highest affinity for tyrosine phosphorylated peptides, especially in the context of the truncated p85 $\alpha$  splice variants [31, 39]. The potential functional importance of arginine 409 is suggested by the finding that this residue is conserved between the four published mammalian species (human, bovine, murine, rat); additionally it is conserved between the different adaptor subunits p85 $\alpha$  and p85 $\beta$ , whereas in p55 $\gamma$  it is replaced by histidine, a conservative change. Residue 409 is not directly in the phosphotyrosine-binding pocket of p85 $\alpha$  [40] so any effect on binding to phosphotyrosine would be by effect on overall conformation. Structural modelling has suggested that the position of the non-conservative variant Arg<sup>409</sup>Gln within the N-terminal SH2 domain might affect the folding of p85 $\alpha$  domains (M. Zvelebil, personal communication).

The proband of our family is a severely insulin-resistant young woman with acanthosis nigricans and hyperandrogenism. Her younger brother is also severely hyperinsulinaemic with acanthosis nigricans developing at a young age. The mutation is present in both subjects. Although the size of the available extended family is too small to provide formal genetic proof of linkage, of particular note is the proband's maternal grandmother whom despite a low body mass index has a greatly increased plasma insulin of 177 pmol/l. The multiple genetic and environmental influences on insulin sensitivity are reflected by the fact that even in families with pathogenic insulin receptor mutations there is enormous interindividual



variability in severity of hyperinsulinaemia [2]. Accordingly, it is perhaps not surprising that full penetrance of the complete syndrome of severe insulin resistance is not seen in this pedigree.

In transfection studies the Arg<sup>409</sup>Gln mutation was consistently associated with a reduction in insulin-stimulated PI 3K activity in anti-phosphotyrosine immunoprecipitates. Further experiments were undertaken to examine possible molecular mechanisms underlying this defect in signal transduction. Recruitment of the mutant p85 $\alpha$  into phosphotyrosine-containing signalling complexes such as the insulin receptor substrates was examined. The expression of epitope-tagged forms of wild-type p85 $\alpha$  and the Arg<sup>409</sup>Gln mutant confirm that within intact cells the mutation has no effect on the level of recruitment of the adapter subunit into insulin-induced signalling complexes. In addition, *in vitro* binding data using the BIAcore surface plasmon resonance system also showed that the Arg<sup>409</sup>Gln mutation had no effect on the binding of p85 $\alpha$  to tyrosine phosphorylated peptides. The use of both monophosphorylated and diphosphorylated peptides in this study excludes the possibility of impaired binding at one or both SH2 domains due to an effect on the conformation of p85 $\alpha$ . It could be argued that the use of phosphopeptides derived from the PDGF  $\beta$  receptor rather than from IRS-1 makes this observation less relevant to insulin signalling; it is known, however, that the main determinants of phosphopeptide binding to SH2 domains in this system are the presence of YXXM motifs which are present in both IRS-1 and PDGF  $\beta$  receptors [31].

This leaves two further ways in which the mutant could be affecting insulin's stimulation of PI 3K activity. The simplest of these is that the catalytic activity of the p85/p110 might be lower when the mutant forms of p85 $\alpha$  are present in the heterodimer. This is clearly not the case, however, as the epitope tagging has allowed us to directly compare the intrinsic PI 3K activity between wild-type and mutant p85 $\alpha$  while controlling for the expression of p85 $\alpha$  and p110 $\alpha$  present in the immunoprecipitates and these are very similar.

The third possibility relates to the reports that full activation of PI 3K catalytic activity requires the binding of phosphotyrosyl residues to both SH2 domains of p85 $\alpha$  [41–43]. The molecular basis of this increase in the activity of the catalytic subunit is not known, but could involve a conformational change in the SH2 domains being transferred by the inter-SH2 domain to the p110 catalytic subunit. It is therefore possible that mutations in p85 $\alpha$  could affect insulin's ability to activate PI 3K through the phosphotyrosine interactions with the SH2 domains. Indeed, this appears to be the most likely mechanism for the adverse effect of the Arg<sup>409</sup>Gln mutation as its associated enzymatic activity is reduced in the

face of similar recruitment to phosphotyrosine-containing signalling intermediates even though the stoichiometry of its physical interaction with p110 $\alpha$  seems unimpaired.

How might such an apparently subtle mutation in PI 3K contribute to such a pronounced clinical phenotype? It seems implausible that heterozygosity for a mutant protein that shows only a modest decrease in its *in vitro* function could result in severe insulin resistance. We have recently discussed how subtle inherited defects in insulin action could lead to a progressive perturbation of glucose homeostasis through the adverse effects on insulin sensitivity of compensatory hyperinsulinaemia [44]. This phenomenon is clearly shown by the progressive development of insulin resistance and diabetes in mice rendered heterozygous null for the insulin-sensitive glucose transporter GLUT4 [45]. Alternatively, the p85 $\alpha$  variant might only result in severe insulin resistance if it is co-inherited with other genetic factors predisposing to insulin resistance. Thus, although heterozygous knock out mice for either the insulin receptor or IRS-1 locus are largely normal, doubly heterozygous mice develop progressive severe insulin resistance and diabetes [46]. Finally, it is probable that we have underestimated the functional defect in PI 3K activation in our cellular system as endogenous PI 3K is contributing to the overall measured enzymatic activity. Insulin-stimulated PI 3K activity from mock transfected cells was approximately 20% of cells transfected with wild-type p85 $\alpha$  and p110 $\alpha$  (data not shown).

Establishing the underlying basis for defective insulin action in people with clinical syndromes of extreme insulin resistance remains a challenging problem. Apart from insulin receptor gene mutations, monogenic causes of severe insulin resistance have been elusive. Mutations in IRS-1 are uncommon in severe insulin resistance, although one person with a missense mutation in IRS-1 has been described [47]. The Gly<sup>972</sup>Arg IRS-1 polymorphism has been associated with Type II diabetes [48, 49] as have mutations in the PTB domain of IRS-1 [50]. The evidence implicating the Arg<sup>409</sup>Gln mutation in the p85 $\alpha$  subunit of PI 3K as a causative factor in the severe insulin resistance of the family described in this report is, however, arguably the strongest for the existence of an inherited post-receptor defect in human insulin action.

*Acknowledgements.* K.C.R. Baynes is supported by a Wellcome Trust Research Training Fellowship and a Sackler Research Studentship. P.R. Shepherd is partly supported by funding from the UK Medical Research Council. We wish to thank Professor M. Waterfield (Ludwig Institute for Cancer Research, London) for generous provision of p85 $\alpha$  and p110 $\alpha$  vectors, Professor K. Siddle and Dr. B. Ursø (University of Cambridge) for helpful discussions, Professor N. Hales and Dr. N. Wareham (University of Cambridge) for provision of UK control DNA samples, Dr. O. Pedersen (Steno Diabetes Center, Gentofte, Denmark) for provision of Danish DNA samples and the families involved, for their helpful cooperation.

## References

1. Tritos NA, Mantzoros CS (1998) Clinical review 97 – Syndromes of severe insulin resistance. *J Clin Endocrinol Metab* 83: 3025–3030
2. Moller DE, Flier JS (1991) Insulin resistance – mechanisms, syndromes, and implications. *N Eng J Med* 325: 938–948
3. Moller DE, O'Rahilly S (1993) Syndromes of severe insulin resistance: clinical and pathophysiological features. In: Moller DE (ed) *Insulin resistance*. Wiley, Chichester, pp 49–81
4. Taylor SI, Moller DE (1993) Mutations of the insulin receptor gene. In: Moller DE (ed) *Insulin resistance*. Wiley, Chichester, pp 83–113
5. Krook A, Kumar S, Laing I et al. (1994) Molecular scanning of the insulin receptor gene in syndromes of insulin resistance. *Diabetes* 43: 357–366
6. Moller DE, Cohen O, Yamaguchi Y et al. (1994) Prevalence of mutations of the insulin receptor gene in subjects with features of the type A syndrome of insulin resistance. *Diabetes* 43: 247–255
7. Moller DE, Bjorbaek C, Vidal-Puig A (1996) Candidate genes for insulin resistance. *Diabetes Care* 19: 396–400
8. White W, Kahn CR (1994) The insulin signaling system. *J Biol Chem* 269: 1–4
9. White MF (1998) The IRS-signalling system: a network of docking proteins that mediate insulin action. *Mol Cell Biochem* 182: 3–11
10. Ogawa W, Matozaki T, Kasuga M (1998) Role of binding proteins to IRS-1 in insulin signalling. *Mol Cell Biochem* 182: 13–22
11. Vanhaesbroeck B, Leegers SJ, Panayotou G, Waterfield MD (1997) Phosphoinositide 3-kinases: a conserved family of signal transducers. *Trends Biochem Sci* 22: 267–272
12. Shepherd PR, Withers DJ, Siddle K (1998) Phosphoinositide 3-kinase: the key switch mechanism in insulin signalling. *Biochem J* 333: 471–490
13. Holman GD, Kasuga M (1997) From receptor to transporter: insulin signalling to glucose transport. *Diabetologia* 40: 991–1003
14. Flier JS, Young J, Landsberg L (1980) Familial insulin resistance with acanthosis nigricans, acral hypertrophy, and muscle cramps. *N Engl J Med* 970–973
15. Dib K, Whitehead JP, Humphreys PJ et al. (1998) Impaired activation of phosphoinositide 3-kinase by insulin in fibroblasts from patients with severe insulin resistance and pseudoacromegaly – A disorder characterized by selective postreceptor insulin resistance. *J Clin Invest* 101: 1111–1120
16. Kausch C, Bergemann C, Hamann A, Matthaes S (1999) Insulin-mediated pseudoacromegaly in a patient with severe insulin resistance: association of defective insulin-stimulated glucose transport with impaired phosphatidylinositol 3-kinase activity in fibroblasts. *Exp Clin Endocrinol Diabetes* 107: 148–154
17. Otsu M, Hiles I, Gout I et al. (1991) Characterization of 2 85kd proteins that associate with receptor tyrosine kinases, middle-T/pp60c-*Src* complexes, and PI 3-kinase. *Cell* 65: 91–104
18. Escobedo JA, Navankasattusas S, Kavanaugh WM et al. (1991) cDNA cloning of a novel 85 kd protein that has SH2 domains and regulates binding of PI 3-kinase to the PDGF  $\beta$ -receptor. *Cell* 65: 75–82
19. Skolnik EY, Margolis B, Mohammadi M et al. (1991) Cloning of PI 3 kinase-associated p85 utilizing a novel method for expression/cloning of target proteins for receptor tyrosine kinases. *Cell* 65: 83–90
20. Fry MJ, Panayotou G, Dhand R et al. (1992) Purification and characterization of a phosphatidylinositol 3-kinase complex from bovine brain by using phosphopeptide affinity columns. *Biochem J* 288: 383–393
21. Gout I, Dhand R, Panayotou G et al. (1992) Expression and characterization of the p85 subunit of the phosphatidylinositol 3-kinase complex and a related p85-Beta protein by using the Baculovirus expression system. *Biochem J* 288: 395–405
22. Pons S, Asano T, Glasheen E et al. (1995) The structure and function of p55<sup>PIK</sup> reveal a new regulatory subunit for phosphatidylinositol 3-kinase. *Mol Cell Biol* 15: 4453–4465
23. Inukai K, Anai M, Vanbreda E et al. (1996) A novel 55-kDa regulatory subunit for phosphatidylinositol 3-kinase structurally similar to p55PIK is generated by alternative splicing of the p85-alpha gene. *J Biol Chem* 271: 5317–5320
24. Inukai K, Funaki M, Ogihara T et al. (1997) p85 $\alpha$  gene generates three isoforms of regulatory subunit for phosphatidylinositol 3-kinase (PI 3-kinase), p50 $\alpha$ , p55 $\alpha$  and p85 $\alpha$ , with different PI 3-kinase activity elevating responses to insulin. *J Biol Chem* 272: 7873–7882
25. Antonetti DA, Algenstaedt P, Kahn CR (1996) Insulin receptor substrate-1 binds two novel splice variants of the regulatory subunit of phosphatidylinositol 3-kinase in muscle and brain. *Mol Cell Biol* 16: 2195–2203
26. Fruman DA, Cantley LC, Carpenter CL (1996) Structural organization and alternative splicing of the murine phosphoinositide 3-kinase p85 $\alpha$  gene. *Genomics* 37: 113–121
27. Shepherd PR, Nave BT, Rincon J et al. (1997) Differential regulation of phosphoinositide 3-kinase adapter subunit variants by insulin in human skeletal muscle. *J Biol Chem* 272: 19000–19007
28. Terauchi Y, Tsuji Y, Satoh S et al. (1999) Increased insulin sensitivity and hypoglycaemia in mice lacking the p85 $\alpha$  subunit of phosphoinositide 3-kinase. *Nat Genet* 21: 230–235
29. Jackson TR, Stephens LR, Hawkins PT (1992) Receptor specificity of growth factor-stimulated synthesis of 3-phosphorylated inositol lipids in Swiss 3T3 cells. *J Biol Chem* 267: 16627–16636
30. Vadnal RE, Parthasarathy R (1989) The identification of a novel inositol lipid, phosphatidylinositol trisphosphate (PIP<sub>3</sub>), in rat cerebrum using in vivo techniques. *Biochem Biophys Res Commun* 163: 995–1001
31. Panayotou G, Gish G, Truong O et al. (1993) Interactions between SH2 domains and tyrosine-phosphorylated platelet-derived growth factor  $\beta$ -receptor sequences: analysis of kinetic parameters by a novel biosensor-based approach. *Mol Cell Biol* 13: 3567–3576
32. Baier LJ, Wiedrich C, Hanson R, Bogardus C (1998) Variant in the regulatory subunit of phosphatidylinositol 3-kinase (p85 $\alpha$ )-preliminary evidence indicates a potential role of this variant in the acute insulin response and type 2 diabetes in Pima women. *Diabetes* 47: 973–975
33. Williams DRR, Wareham NJ, Brown DC et al. (1995) Undiagnosed glucose intolerance in the community – the Isle of Ely Diabetes Project. *Diabet Med* 12: 30–35
34. Kawanishi M, Tamori Y, Masugi J et al. (1997) Prevalence of a polymorphism of the phosphatidylinositol 3-kinase p85 $\alpha$  regulatory subunit (codon 326(Met→Ile)) in Japanese NIDDM patients. *Diabetes Care* 20: 1043
35. Bjornholm M, Kawano Y, Lehtihet M, Zierath JR (1997) Insulin receptor substrate-1 phosphorylation and phosphatidylinositol 3-kinase activity in skeletal muscle from NIDDM subjects after in vivo insulin stimulation. *Diabetes* 46: 524–527

36. Goodyear LJ, Giorgino F, Sherman LA et al. (1995) Insulin receptor phosphorylation, insulin receptor substrate-phosphorylation, and phosphatidylinositol 3-kinase activity are decreased in intact skeletal muscle strips from obese subjects. *J Clin Invest* 95: 2195–2204
37. Rondinone CM, Wang LM, Lonroth P et al. (1997) Insulin receptor substrate (IRS) 1 is reduced and IRS-2 is the main docking protein for phosphatidylinositol 3-kinase in adipocytes from subjects with non-insulin-dependent diabetes mellitus. *Proc Natl Acad Sci USA* 94: 4171–4175
38. Hansen T, Andersen CB, Echwald SM et al. (1997) Identification of a amino acid polymorphism in the p85 $\alpha$  regulatory subunit of phosphatidylinositol 3-kinase. *Diabetes* 46: 494–501
39. Yu JH, Wjasow C, Backer JM (1998) Regulation of the p85/p110 $\alpha$  phosphatidylinositol 3'-kinase – Distinct roles for the N-terminal and C-terminal SH2 domains. *J Biol Chem* 273: 30199–30203
40. Nolte R, Eck M, Schlessinger J, Shoelson S, Harrison S (1996) Crystal structure of the PI 3-kinase p85 amino-terminal SH2 domain and its phosphopeptide complexes. *Nat Struct Biol* 3: 364–373
41. Herbst A, Andrews G, Contillo L et al. (1994) Potent activation of phosphatidylinositol 3'-kinase by simple phosphotyrosine peptides derived from insulin receptor substrate-1 containing 2 YMXM motifs for binding SH2 domains. *Biochemistry* 33: 9376–9381
42. Carpenter CL, Auger KR, Chanudhuri M et al. (1993) Phosphoinositide 3-kinase is activated by phosphopeptides that bind to the SH2 domains of the 85-kDa subunit. *J Biol Chem* 268: 9478–9483
43. Rordorf-Nikolic T, Van Horn DJ, Chen DX, White MF, Backer JM (1995) Regulation of phosphatidylinositol 3'-kinase by tyrosyl phosphoproteins – full activation requires occupancy of both SH2 domains in the 85-kDa regulatory subunit. *J Biol Chem* 270: 3662–3666
44. O'Rahilly S (1997) Diabetes in midlife: planting genetic time bombs. *Nat Med* 3: 1080–1081
45. Stenbit AE, Tsao TS, Li J et al. (1997) GLUT4 heterozygous knockout mice develop muscle insulin resistance and diabetes. *Nat Med* 3: 1096–1101
46. Bruning JC, Winnay J, Bonner-Weir S et al. (1997) Development of a novel polygenic model of NIDDM in mice heterozygous for IR and IRS-1 null alleles. *Cell* 88: 561–572
47. Whitehead JP, Humphreys P, Krook A et al. (1998) Molecular scanning of the insulin receptor substrate 1 gene in subjects with severe insulin resistance – detection and functional analysis of a naturally occurring mutation in a YMXM motif. *Diabetes* 47: 837–839
48. Almind K, Bjorbaek C, Vestergaard H, Hansen T, Pedersen O (1993) Amino acid polymorphisms of insulin receptor substrate-1 in non-insulin dependent diabetes mellitus. *Lancet* 342: 828–832
49. Almind K, Inoue G, Pedersen O, Kahn CR (1996) A common amino acid polymorphism in insulin receptor substrate-1 causes impaired insulin signalling. *J Clin Invest* 97: 2569–2575
50. Yoshimura R, Araki E, Ura S et al. (1997) Impact of natural IRS-1 mutations on insulin signals – mutations of IRS-1 in the PTB domain and near SH2 protein binding sites result in impaired function at different steps of IRS-1 signalling. *Diabetes* 46: 929–936