



3. Distribution of present-day biodiversity

Biodiversity is unevenly distributed across the planet. A range of factors contribute to this distribution, including the global climatic gradient, the current and historical distribution of land masses, and geographical barriers, such as mountains.

In addition, our perception of the diversity of life is further influenced by the results of biodiversity surveys and the choice of suitable measurement units, as well as by the species concept used in each study.

This introductory chapter covers the basic principles behind the measurement of biodiversity, including concepts and indices relevant for the description of biodiversity as well as the theoretical and practical foundations for the description of species. For some organismal groups, the species concept is problematic. These groups will be briefly presented here, including viruses, which are subject to Darwinian evolution but are not able to replicate autonomously. To that end, the concept of the 'sub-species' was established for the description of molecular diversity within a host. Lichens are symbioses of a fungal and one or several algal species. A lichen is thus composed of several other species.

The second chapter introduces the biogeographic regions and deals with the climatic and geographical factors contributing to the differentiation of these areas. This includes a discussion about the generalisability to other organisms of key biogeographic concepts derived primarily from plant and animal case studies, as well as of anthropogenically influenced global biodiversity trends.

The regions of the world can be grouped ecologically and biogeographically on the one hand into biomes (or ecozones)

and, on the other, into faunal and floral kingdoms. In contrast with the ecologically-defined biomes, faunal and floral kingdoms are characterised by phylogenetically related taxa.

Faunal and floral kingdoms are defined by the occurrence of many plant and animal taxa within the particular area. This distinction is aimed at phylogenetic relationships, *i.e.* endemic species, genera and families, and not the adaptation of these organisms to specific environmental conditions.

The biome was originally understood as a basic unit of biocenosis, and thus used as a synonym for the formation of a climax community. Indeed, the term 'biome' is derived from the term bioformation, which refers to biocenosis across a vast area of the Earth and is defined in terms of the climax vegetation found in this area.

The term 'biome' is now used more specifically in an ecological sense for ecosystems bearing vegetation which appears to be the same or is constructed in the same way. Biomes are strongly tied to climatic factors; their distribution is, therefore, not a chance occurrence but, rather, occurs in parallel with global climate zones and climate-driven soil types.

The biome concept was previously used as a synonym for bioformation; today, however, it is viewed as more closely related to the geoscientific 'ecozone' term. Ecozones are vast areas on Earth containing largely similar climate, vegetation, soil, and agricultural land. Ecozones closely correspond to biomes, though their definition is more strongly driven by abiotic factors.



3.1 Basics of biodiversity

This chapter introduces concepts in the measurement and description of biodiversity. This includes an explanation of the most frequently used biodiversity indices. This chapter also introduces practical implications and challenges around species description, especially related to exclusively molecular approaches



3.2 Biodiversity distribution

This chapter covers the distribution of Earth's extant biodiversity, including estimates of total species counts and the factors responsible for species biogeography. This chapter also introduces trends in global biodiversity and the formation of biogeographical habitats



Basics of the biogeographical distribution of taxa

■ Biogeography is concerned with the distribution of species, which range from the punctiform to the global. A rat, for example, is globally distributed. Most species ranges lie in between these extremes.

Species distributions depend on ecological tolerance (the range of tolerated environmental conditions), competition levels, geographical factors (mountain ranges or oceans), and historical circumstances. Historical factors influencing species distribution are related, in part, to the historical development of the natural habitat, including plate tectonics and climatic history, as well as to the 'age' of the individual species. To that end, 'young' species, which only recently evolved, often have a narrower distribution than do the 'older' ones since they have only had the chance to colonise potential natural habitats close to their region of origin.

The distribution of organisms is also linked to the taxonomic resolution of the observation: individuals, for example, have a defined, localised distribution. Groups containing

■ Considering the relationship between the taxonomic resolution and the species distribution patterns is of practical relevance in a number of ways.

Many conservation measures depend on both the number of individuals in question and the size of their distribution area. Both the number of individuals and the distribution area depend on the study's taxonomic resolution and the particular species concept used. Molecular analyses show that many morphological species, for example, are actually distinct species complexes comprised of a number of biological species. Although the actual distribution remains the same, the distribution range of the morphological species is broken up into several different distribution areas of the biological species. As a consequence, common and widespread morphological species may actually be a species complex comprising rare, endemic taxa. In these cases, the knowledge or use of a different species concept would be highly relevant for planning future conservation strategies.

The complexities of species definitions are even more pronounced in the case of microorganisms, where it remains

several individuals, by definition, exist over a wider distribution known as their range.

Species often have local or regional distributions. Integrating range of several species, as is the case when considering genera and other higher-level taxonomic units, results in more extensive distribution areas. This type of analysis would simultaneously consider the ranges of all of the species. This relationship appears trivial at first, but it is of fundamental importance for the understanding of biodiversity patterns. This is especially true for comparative analyses examining the range of different species: both the species concept itself and the definition of the individual species are fraught with problems. As a result, the species boundaries of many organisms are not completely clarified.

Furthermore, the definition of 'species' differs with the taxonomic group. As a consequence, species with broad definitions should be expected to have a wider distribution range as compared to species that are narrowly defined.

unknown to what extent species correspond to the understanding of species in higher organisms. Species in microorganisms are possibly more comparable with the higher taxonomic units in metazoan and land plants. In addition, relatively few microorganisms have been characterised taxonomically, and their distribution patterns remain largely unknown.

Depending on the interpretation and on the species concept used, microorganisms can be understood to have very wide or very narrow distributions. A popular viewpoint regarding the distribution of microorganisms is the 'Everything is Everywhere' hypothesis, which claims that species under a certain size are found globally and that only the ecological conditions of the habitat in question determine whether a species occurs locally. Opponents of this view posit that microorganisms and higher organisms are both largely comprised of endemic organisms and therefore have similar distribution patterns.

endemic: occurrence of organisms within a defined geographical area

punctiform distribution: only in one place or at a point, little spatial distribution

■ **See also:** Biogeography of microorganisms: 3.2.1.6



At the family level, distribution patterns span almost the entire planet. Corvids (Corvidae) are commonly found across Earth, with the exception of southern South America and some tundra areas. The following representative species are shown here: *Pica pica* (maggie, top-left), *Corvus monedula* (daws, top-centre), *Corvus cornix* (or *Corvus corone cornix*, hooded crows, top-right), *Garrulus glandarius* (jays, bottom-left), *Corvus corax* (raven, bottom-middle), *Corvus corone* (or *Corvus corone corone*, carrion crow, bottom-right)



At the genus level, distribution patterns are often extensive. The magpies (*Pica* spp.), comprised of the *Pica pica* (left), *Pica hudsonia* (black-billed magpie, top-right), and *Pica nuttalli* (yellow-billed magpie, bottom-right), inhabit a large part of the temperate zone of the Northern Hemisphere



Species have limited distribution areas. The range of the yellow-billed magpie (*Pica nuttalli*) extends across a small strip along the west coast of the United States



Individuals exist at a precise location and time



Species descriptions

■ The description of a species relies upon a number of disciplines within biology, including systematics, taxonomy, and nomenclature. Systematics includes the determination and reconstruction of the phylogenies, or trees of life, of living organisms. Taxonomy, on the other hand, aims to provide a hierarchical classification system for species. Finally, nomenclature pertains to the naming of organisms. Species description is carried out differently across organismal groups.

However, certain elements of the description are present in all species: the genus and species name should be unique and chosen according to the described organism in question. References to a particular distinctive feature of the location the species was first observed are common. New species descriptions are regulated by a recognised, corresponding nomenclatural code.

■ Species description methodologies change with the development of novel scientific methods. For example, the rise of PCR and sequence analyses increasingly led to the use of molecular data within species descriptions. To that end, new species are sometimes even designated based on molecular features alone, though such an approach is problematic specifically in light of taxonomic revisions due to the lack of data to compare with other similar species. Therefore, it is helpful when all of the underlying theoretical underpinnings of the species delimitation – specifically the applied species concept – are stated for the comparative assessment of different species descriptions.

As a result of new findings, many species have been shifted into other or novel genera. Though the ‘old’ species

Central to the description of any species is a species diagnosis; that is, the exact description of the new species, especially in light of its distinguishing features compared to closely related species. The species diagnosis commonly contains a morphological description and, in more recent work, a DNA sequence description. The initial species description is commonly carried out on an individual specimen with species-specific characteristics, which is ideally subsequently archived as a holotype in research collections of museums or other scientific institutions. A picture or a drawing of characteristic features of the holotype should accompany the species diagnosis within the initial publication. A DNA sample is often also deposited in a DNA bank.

assignment has been invalidated, species may remain in the literature under a number of names, specifically if the names have become popular and are in common use.

A large number of species have, therefore, been independently described two or more times for a number of reasons, including the existence of intraspecific variants, sexual dimorphism, or clear generational change within a species. Even ignorance of an existing description can lead to double descriptions. Species descriptions may also be considered invalid because they do not apply rules specific to a particular discipline.

As a result of all of these factors, it is vital to make a distinction between the number of published species names and the number of valid species that may exist in nature.

DNA bank: institution in which DNA samples extracted from organisms can be stored for future testing

holotype: a single individual organism which was used as the name-bearing type when a species or sub-species was first described

intraspecific: occurring or existing within a species or between individuals of the same species

Polymerase Chain Reaction (PCR): laboratory technique used to make multiple copies of a segment of DNA

sexual dimorphism: (Lat.: *sexus* = gender; Grk.: *dimorphos* = having two forms) differences in appearance between male and female individuals of the same species



Chlorella pulchelloides C. Bock, Krienitz et Pröschold, sp. nov. 2011

Diagnosis. Cells colonial, planktonic, with mucilaginous envelope. Colonies 4–32 celled, diameter of colonies 25–35 µm. Adult cells spherical 4.5–6.5 µm, connected via mucilaginous stalks. Young cell oval to ovoid, 3.5–4.5 × 4–6 µm, attached to the stalks at their broader side. Chloroplast single, parietal, cup- or saucer-shaped with ellipsoid to spherical pyrenoid, covered by two starch grains. Reproduction by 2–4 autospores. Release of autospores after rupture of mother cell wall horizontally or slightly obliquely. Differs from other species of this genus by the order of nucleotides in ITS-1 and ITS-2 and the barcoding signatures



Holotype: Material of the authentic strain CCAP 211/118 is cryopreserved at the Culture Collection of Algae and Protozoa, Oban, Scotland.

Isotype: An air-dried as well as a formaldehyde-fixed sample of strain CCAP 211/118 was deposited at the Botanical Museum at Berlin-Dahlem under the designation B40 0040664.

Type locality: Lake Feldberger Haussee, Brandenburg, Germany (53°20'27,35''N; 13°26'10,89''E).

Etymology: from Latin: *pulchella* = nice

Authentic strain: CCAP 211/118

Scientific names are comprised of the genus and species epitheton put together. The complete name also comprises the surname of the describing authors and the year of publication

The species diagnosis should include all of the distinguishing characteristics of the type species and, in particular, how they differ from related species. In the field of plant science, the species diagnosis must be in English or Latin, whereas in zoology it must be written in an established language of science

Species descriptions increasingly also contain sequence data, *i.e.* the sequenced sections of specific marker genes. Often, these sequences code for DNA segments coding for ribosomal RNA, or for other DNA 'barcode' regions established for the respective group of organisms

Species descriptions often include drawings or photographs of the new species, especially for smaller organisms. The diagnosis must, where applicable, define which image or which individual determines the type

As a rule, newly described type species must be deposited. They may be stored as herbarium sheets, as a live culture or as a cryopreserved sample, depending on the organism in question

Species descriptions also include locality information, *i.e.* where the sample was taken

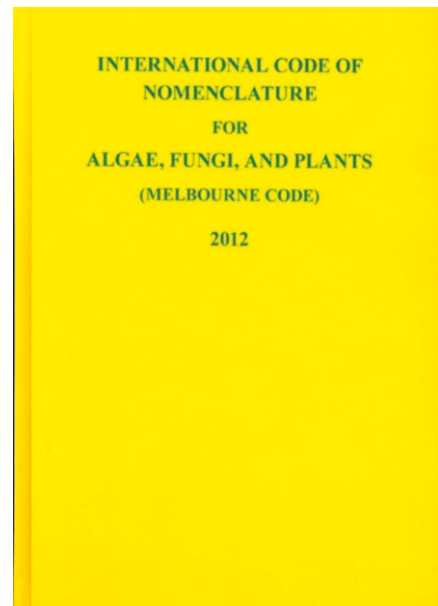
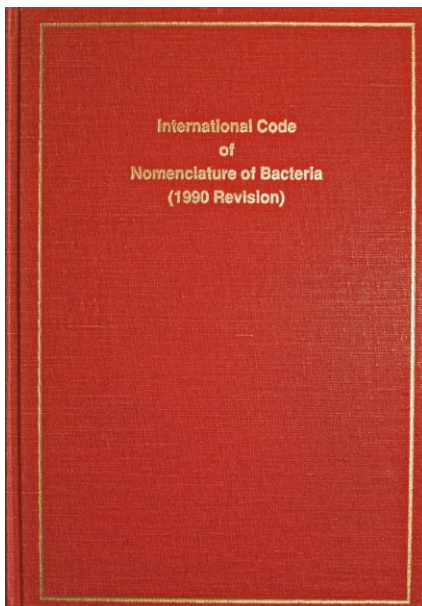
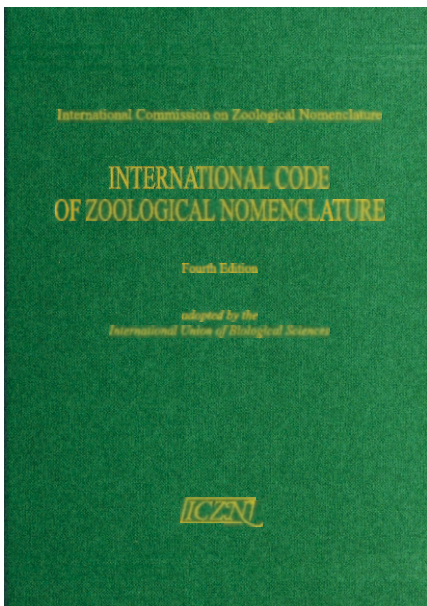



The species concept

■ Delimitating species is different from defining the concept of species, though the two are often mistakenly taken as the same thing. For example, according to the biological species concept, species are defined by their reproductive isolation. In practice, however, the examination of this criterion is complicated, and the recognition of different species is mostly on morphological and molecular dissimilarity.

Biology most commonly uses the biological species concept, where species are groups of actual or possibly compatible natural populations isolated from other such groups by reproductive isolation. Since hybrids may occur after the mating of two different species, a refined definition requires that only descendants within a species are fertile but descendants of two different species are not.

On the other hand, the 'recognition' species concept is based on species that are defined as sex partners – be it at the level of gametes, sex apparatus, or of individuals – that can recognise each other as sex partners.

■ A number of species concepts have thus far been proposed. Common to all of these is the demarcation of independently evolving populations within a larger metapopulation. Yet, different species concepts vary in their reliance on particular features.

Typological species concepts use morphological, physiological, or ethological properties to classify organisms. The morphological and chronological (historical) species concepts are both typological, as is the physiological species concept, as applied in prokaryotes.

In contrast, the biological species concept hinges on fertility, a property that can only be observed in living species.

In contrast with biology, which considers only extant (living) species, palaeontology also accounts for the change of species over time. Palaeontologists only have the morphological features of fossils at their disposal, whereas biologists can examine the molecular, behavioural, and phylogenetic features. Therefore, palaeontology almost always uses a 'morphological' species concept, delimiting species based on physical differences. The often-applied 'chronological' species concept is basically a morphological species concept, but it allows for the variation of species over geological time periods. Strictly speaking, it is not an alternative concept but, rather, it is a differential practice of species delimitation.

The different practices of species delimitation in biology and palaeontology are, therefore, largely a matter of the possibilities of species identification and delimitation rather than a matter of deviating species concepts.

In addition to the biological and typological concepts are the evolutionary and phylogenetic definitions of the species: the evolutionary species concept is based on a common evolutionary fate with common evolutionary roles and developments. Similarly, a phylogenetic species concept defines monophyletic lineages as separate entities. Finally, the genotypic cluster concept, which hinges on a low frequency of clusters of intermediate forms (not their complete absence), is sometimes also used.

The ecological species concept can be seen as a variant of the evolutionary species concept, defining species according to their occurrence in the same ecological niche or adaptive zone.

adaptive zone: the combination of environmental conditions and ecological niches respectively, which are occupied by species that exploit the same resources in a similar way

Horizontal Gene Transfer (HGT): the transfer of genes between organisms without reproduction; also between species

metapopulation: group of several individual populations between which gene flow is restricted

reproductive isolation: a set of barriers impeding the gene flow between two populations; examples of such barriers might be geographical separation, genital incompatibility, or behavioural differences

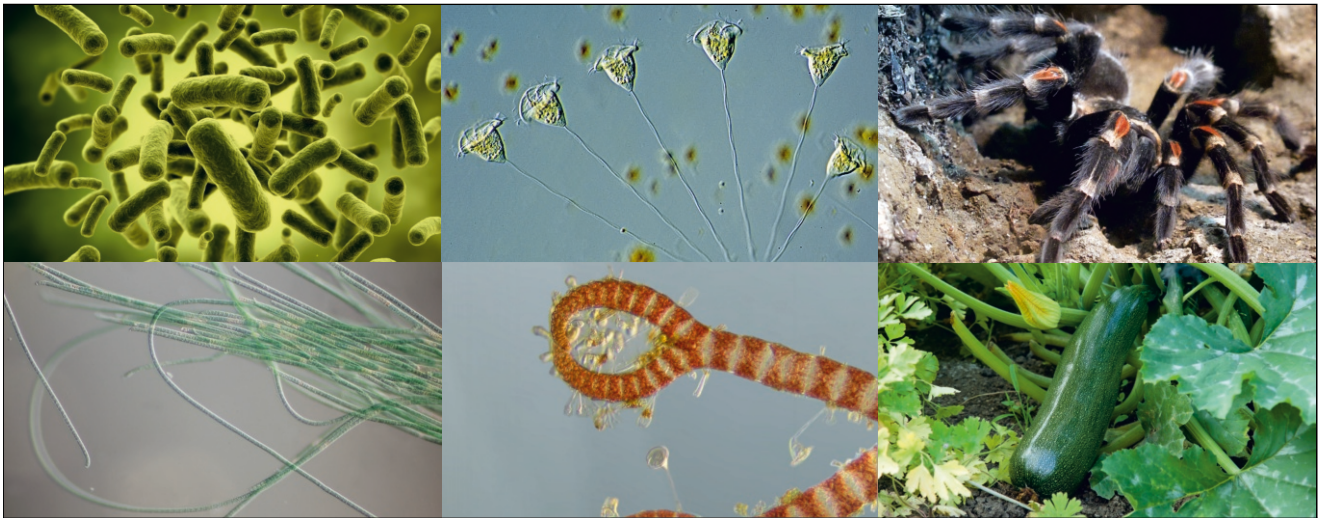

Species are defined differently between major organismal groups and by the different species concepts used. Microorganism species are often defined based on genetic variations that may already indicate genus or family level in higher animals and plants

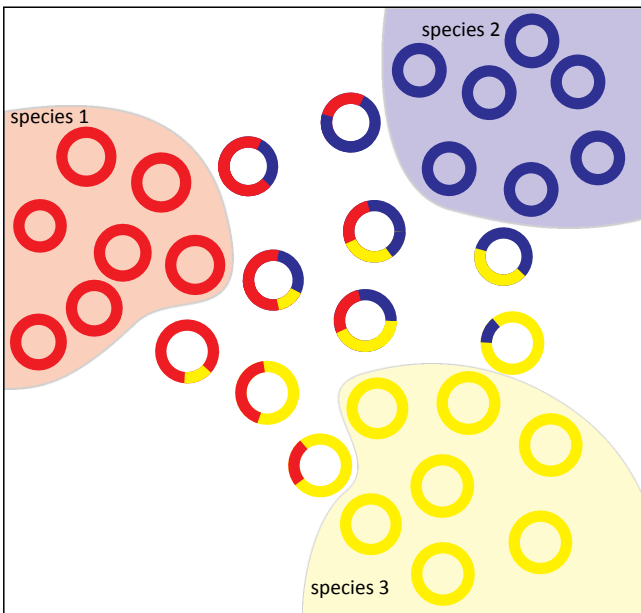

Prokaryotes pose a major challenge in delineating species, since different species can show similarities to each other as a result of lateral gene transfer across large parts of their genome. As a result, distinct organisms would belong to different species at the same time. In this figure, the single-coloured rings represent the genome of the individuals. Multi-coloured rings represent genomes where lateral gene transfer has created a 'mixed' genome

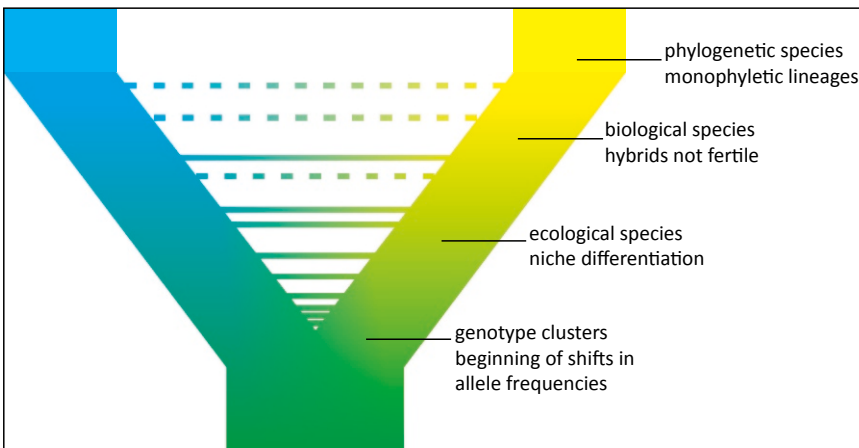

Speciation is usually a continuous process occurring over a longer period of time. Various species concepts apply different criteria for the definition of species, represented at different points within the speciation process. Thus, genotypic clusters are often observed when gene flow between two sub-populations is still high. The ecological species concept, which is based on niche differentiation, requires a stronger restriction of genetic exchange, despite niche differentiation. However, genetic exchange is minimal between biological species and non-existent between monophyletic lines



Molecular diversity and OTUs

The determination and identification of species requires expert knowledge and is very time consuming. In addition, it is increasingly clear that a vast majority of existing species will not be described in the near future. As a result, DNA sequencing methods have been developed to allow for the relatively quick identification of organisms based on snippets of their genetic code, a strategy superficially resembling the barcoding of products by way of scanners in a supermarket. This is known as DNA barcoding.

DNA barcoding is a taxonomic method of species determination based on the DNA sequence of a specific target marker gene. For many organisms, and especially for metazoans, DNA barcoding targets the cytochrome c oxidase subunit 1, often referred to as COI or *cox1*.

A fundamentally different way of detecting biodiversity using molecular techniques is to group sequences into operational taxonomic units, or OTUs. In most molecular di-

Finding a uniformly applicable concept of a single barcode, in other words, a unique sequence section for the identification of species is both difficult and controversial. For one, the portions of sequences selected for barcoding are themselves subject to evolution. Mutations and intraspecific variation are also common within such barcode regions. Therefore, a 'barcoding gap' is often applied, a standard sequence threshold used to differentiate species, where intraspecific variability (within one species) of a genetic sequence should be much smaller than the sequence divergence between different species.

A second problem is that the extent of sequence variability of a distinct gene differs between organismal groups. As a result, the original idea of creating a single barcode that is applicable to all groups is therefore not feasible. Most metazoan cells are targeted at the mitochondrial DNA regions. Plastid DNA is targeted in plants, whereas, in fungi, the internal transcribed spacer 1 (ITS1) region of the ribosomal DNA is often used as a barcode. There is still great debate about the feasibility and potential target regions for barcoding in protists.

versity studies, the majority of sequences obtained from the environment do not belong to the known species that are genetically characterised. It is, therefore, difficult to determine how different these sequences are from those of related species and how big the intraspecific diversity is, in other words, how much genetic diversity there is within a known species.

Ideally, using OTUs should contribute to the accuracy of estimations of species richness by broadening the threshold of sequence variability within a species. OTUs should not be formed based on variation as a result of sequencing error, yet this often contributes to selection of OTU cut-off-levels in practice. OTUs determined through an environmental sequencing study often have little to do with the precise species in nature. Still, they can be useful for measuring diversity by allowing for an approximate assignment of organisms to a kinship group.

DNA barcoding elicits further problems, most importantly because its purpose clashes with the requirements of other molecular diversity studies.

In many studies, DNA sequence segments are used as phylogenetic markers, *i.e.* as sequences that will allow for the phylogenetic classification of organisms via the calculation of phylogenetic trees. However, the requirements for such markers are different from those of a barcode. Highly conserved sequence segments should flank phylogenetic marker genes used in diversity studies in order to make sure that PCR primers target a broad variety of organisms. The requirement for sequence variability within the marker region itself also differs between the different applications. For phylogenetic studies, they need to allow for phylogenetic assignment across the whole target group, *e.g.* for eukaryotes. These sequences are usually too conserved to reliably differentiate between closely related species. The ribosomal RNA of the small ribosomal subunit, known as the SSU rRNA (hereafter referred to as the 16S rRNA in prokaryotes and the 18S rRNA in eukaryotes), are frequently used as markers for such molecular phylogenetic studies.

16S: the small subunit of prokaryotic ribosomes, as well as plastids and mitochondria with a sedimentation coefficient of 16 Svedberg (S) units

18S: the small subunit of eukaryotic ribosomes with a sedimentation coefficient of 18 Svedberg (S) units

primers: primers are short strands of nucleic acid with complementary reverse sequences directed at a target sector which they

bind onto, thereby serving as the starting point for polymerase enzymes to catalyse the polymerase chain reaction (PCR)

Small Subunit (SSU): the small subunit of ribosomes; the term refers to both the 16S subunit of prokaryotic ribosomes as well as the 18S subunit of eukaryotic ribosomes



The term 'barcode of life' (BOL) is based on the idea of barcodes for goods. Barcodes are designed to allow for the clear identification of organisms based on DNA sequence segments. Barcodes should enable non-specialists to identify species and, ideally, at the same time, allow for phylogenetic placement in molecular diversity studies. On the one hand, the requirements of taxonomic distinctiveness and on the other, as phylogenetic markers in diversity studies of known groups are usually not compatible

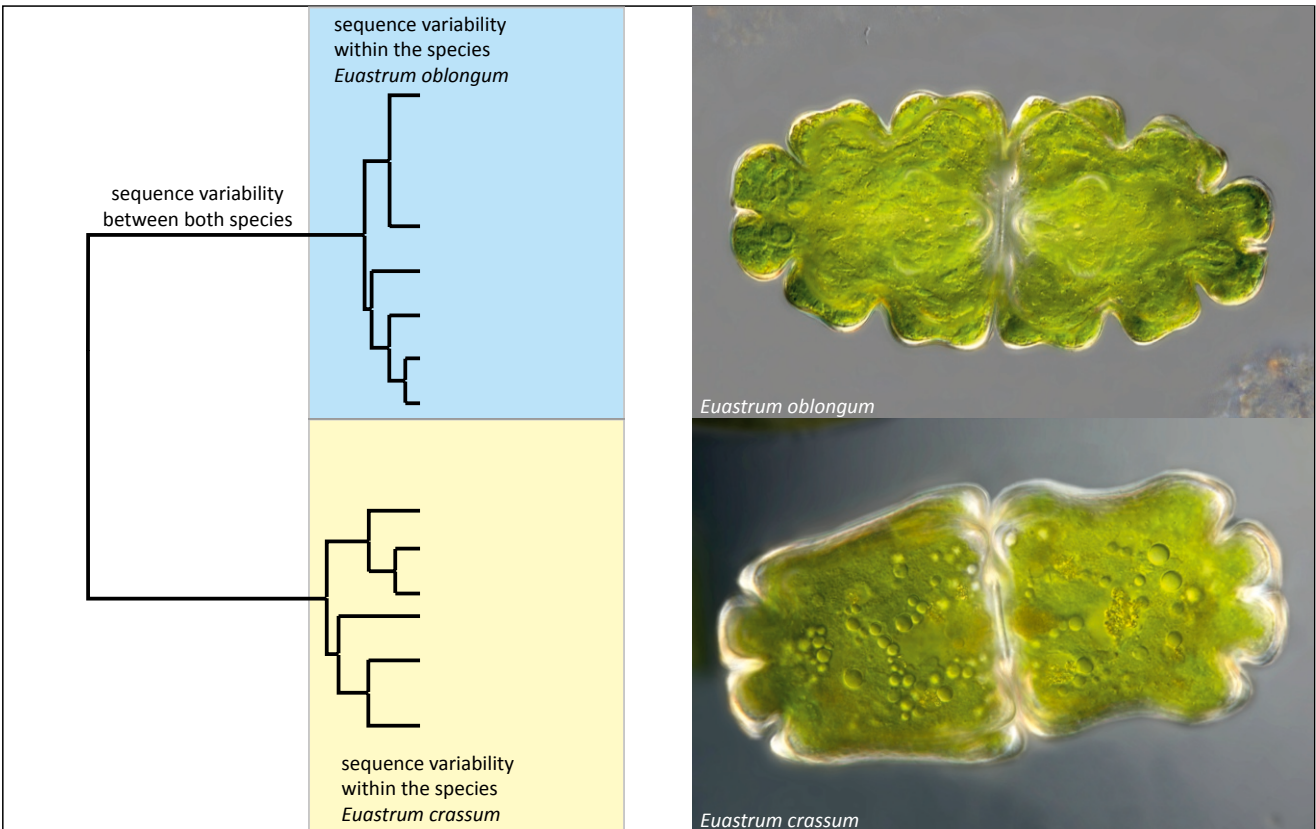

A 'barcode gap' is used to define the difference between intraspecific and interspecific variability, where the difference in sequence variation should be significantly less within a species compared to variation between species that are closely related. As a result, effective barcodes have only been established for organismal groups where the majority of species have already been described, in particular, in higher plants and animals



Biodiversity indices

■ Biodiversity is complex. In research, and perhaps even more so for the communication of science to the public, it is often necessary to break down biodiversity information to one or a few key numbers, or indices.

The term biodiversity is often taken as a synonym for species richness, though these terms are subtly different. Species richness denotes the number of species found in a particular habitat. It is not comprised of information about structural dominance or the distribution of species within that habitat.

The term biodiversity, on the other hand, includes both the number of species present in a habitat (species diversity, or species richness [S]) and the degree of uniformity of their distribution (evenness [E]). A variety of measurements and indices has been developed to describe biodiversity on the basis of these two dimensions. Both do not consider the absolute abundance of species or the total biomass within an area.

■ Each diversity index characterises diversity in a different manner by variations in how they integrate the number of species present and the degree of evenness of their distribution (the uncertainty, similar to the concept of entropy from physics). Most indices consider species richness as well as the evenness of their distribution.

Most diversity indices are proportionate to the sums of the power functions of the relative abundances ($\sum p^q$) of the distinct species (p : relative abundance of the species; q : exponent, different for the different indices).

For the special case of $q = 0$, the formula returns the species richness ($p^0 = 1$, therefore $\sum p^0 =$ number of species). For the case $q = 2$, the formula returns the Simpson-index ($\sum p^2$).

While species richness ($q = 0$) does not consider the relative abundances of species – species are simply summed up – high values of q (as for the Simpson index with $q = 2$) will result in a disproportionately high weight of the relative abundance. Thus, the different indices mainly differ in the weight of these two measures, *i.e.* species richness and evenness. As a result, rare species are overweighted for low

The most widely used diversity index, the Shannon index (H), is comprised of both the species richness and the uniformity of the species distribution within an area. It is sometimes mistakenly referred to as the Shannon-Weaver or Shannon-Wiener index. The Shannon index of uniformly distributed species is equal to the logarithm of natural species diversity (or $H = \ln S$). This index is unlimited and, therefore, can even take large values.

The Simpson index (D), similar to species evenness, provides information about species dominance within a habitat. This index ranges from 0 to 1 and offers the probability that two randomly sampled individuals in a population belong to the same species. Conversely, the Gini-Simpson index ($1-D$) refers to the probability that two randomly selected individuals do not belong to the same species. Compared with the Shannon, the Simpson index is less prone to shifts in biodiversity.

exponents and underweighted for high exponents (e.g. Simpson index).

In a biological context, the species number is usually intuitively considered as the basis for measuring biodiversity: when two communities show the same distribution, for instance, when all species have the same abundance, diversity should be proportionate to the number of entities (*i.e.* species). A community with eight species would be considered twice as diverse as a community with four species. This relationship is reflected by the species richness. In contrast, both the Shannon index and the Simpson index, as the most common diversity indices, do not increase proportionately to the number of species. If, for instance, a meteor causes half of an area's 200,000 species to go extinct (*i.e.* 100,000 species), these two indices would hardly change. For evenly distributed species, the Shannon index would decrease from 12.2 to 11.5, corresponding to 5.6%, and the Gini-Simpson-Index would decrease from 0.999995 to 0.99999, corresponding to 0.0005%. This negligible decrease does not correspond to the intuitive expectations for measures of biodiversity.

dominance structure: frequency distribution (dominance) of the various species in a habitat

relative frequency: the number of individuals in a given species relative to all the individuals of all species living in that habitat

■ See also: α -, β -, γ -diversity: 3.1.5



| species | p | ln (p) | p*ln(p) | p ² |
|-----------------|----------------------|------------------|---------|----------------|
| magpie | 3 / 15 = 0.20 (20 %) | ln (0.20) = -1.6 | -0.32 | 0.040 |
| pheasant | 2 / 15 = 0.13 (13 %) | ln (0.13) = -2.0 | -0.27 | 0.017 |
| bee-eater | 2 / 15 = 0.13 (13 %) | ln (0.13) = -2.0 | -0.27 | 0.017 |
| hoopoe | 2 / 15 = 0.13 (13 %) | ln (0.13) = -2.0 | -0.27 | 0.017 |
| oriole | 2 / 15 = 0.13 (13 %) | ln (0.13) = -2.0 | -0.27 | 0.017 |
| woodchat shrike | 1 / 15 = 0.07 (7 %) | ln (0.07) = -2.7 | -0.19 | 0.005 |
| daw | 1 / 15 = 0.07 (7 %) | ln (0.07) = -2.7 | -0.19 | 0.005 |
| nutcracker | 1 / 15 = 0.07 (7 %) | ln (0.07) = -2.7 | -0.19 | 0.005 |
| jay | 1 / 15 = 0.07 (7 %) | ln (0.07) = -2.7 | -0.19 | 0.005 |
| sum | 1 (100 %) | | -2.16 | 0.128 |

The Shannon index (H) is the negative sum of the product of the proportion of individual taxa in a community and the natural logarithm of this value (here 2.16)

The Simpson index (D) is the sum of the square of relative abundances of individual taxa (in this case, 0.128). The inverse Simpson index (1/D, here 1/0.128 = 7.8) and the Gini-Simpson index (1-D, here 0.872) are most commonly used

Calculation of common diversity indices: the community shown here is comprised of 15 individuals belonging to nine different species. The species richness is therefore nine. The Shannon index is calculated, as shown above, to be 2.16. Likewise, the Simpson index is 0.128

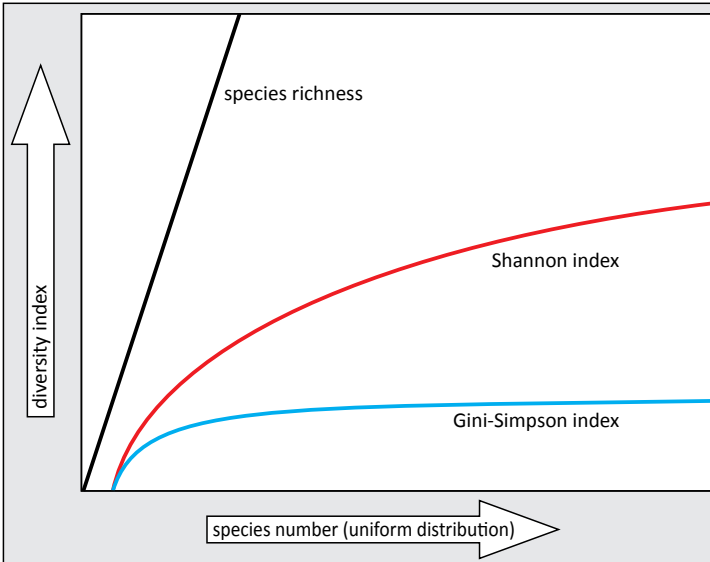

The trend of diversity indices along a gradient of an increasing number of uniformly distributed species: species richness is (linearly) proportional to the number of species present. The Simpson and derived indices (inverse Simpson and Gini-Simpson) as well as the Shannon index are not proportional to the number of species. For uniformly distributed species within a community, the Shannon index corresponds to the logarithm of species richness (ln S), whereas for unevenly distributed communities that value is less. While species richness and the Shannon index increase with increasing diversity, the Simpson index decreases. Therefore the inverse Simpson index or the Gini-Simpson index is more commonly used

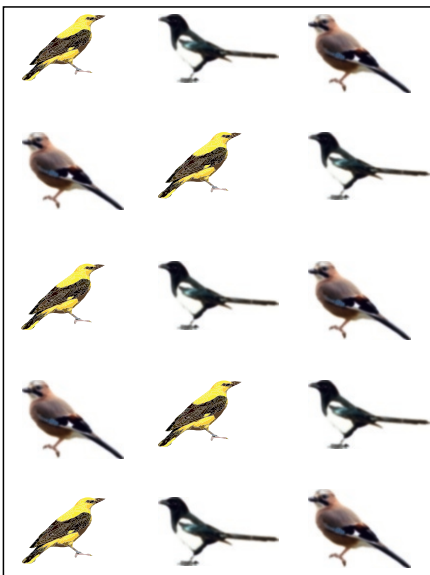

The influence of uneven distribution on biodiversity indices: both communities here consist of 15 individuals, each belonging to one of three species. Here the number of different species (species richness) or, more generally, the number of different types or units (richness), is three in each case. Aside from species richness, the extent of uniformity of the distribution of the units (evenness) is usually part of the diversity indices. In this example, the left panel shows the three species as being evenly distributed, so evenness is high, whereas the right panel shows the magpie individuals outnumbering their counterparts, illustrating a low evenness. The distribution of species is taken into account by the Shannon and Simpson indices

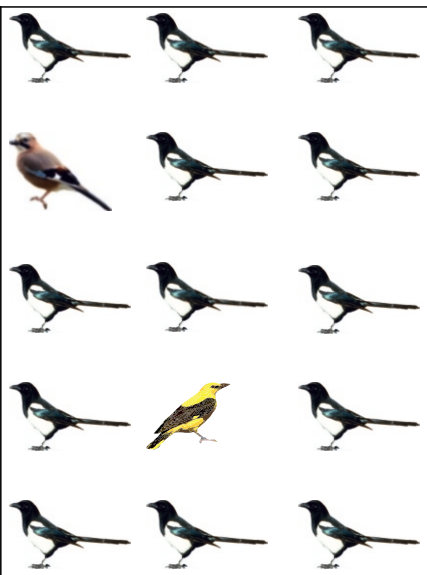



Spatial distribution of biodiversity

■ Assessing of biodiversity always targets a specific spatial area (habitat, region) or the comparison between two areas.

α -diversity (Alpha diversity) describes the diversity of a habitat and is therefore referred to as 'local' diversity. In contrast, γ -diversity describes the diversity of a landscape, or an area. It is therefore similar to α -diversity but at a larger spatial scale. α - and γ -diversity are qualitatively identical and can both, therefore, produce a species richness value for a particular area.

β -diversity describes the difference between α - and γ -diversity, characterising the difference between the diversity of a single habitat (α -diversity) and an entire landscape (γ -diversity). Therefore, β -diversity is a qualitatively different measurement compared with α - and γ -diversity; it describes

■ Diversity indices do not always reflect the intuitive basic assumptions regarding biodiversity. These assumptions include, for example, that diversity should be proportional to the number of species, if the species are evenly distributed; for example, if half of the species go extinct, the diversity in a habitat with uniformly distributed species should drop by half. In addition, the different levels of diversity should relate to each other – depending on the scientific viewpoint – either by addition (α -diversity + β -diversity = γ -diversity) or multiplication (α -diversity x β -diversity = γ -diversity). However, most diversity indices display a limited compliance to these relationships. Particularly in species-rich communities, both the Shannon and Gini-Simpson indices only minimally comply with these assumptions. Thus, calculated changes in

the variability of comparisons between a single entity within a greater whole. While α - and γ -diversity can be directly measured by counting species and their relative abundances, the β -diversity is always calculated.

The Jaccard index is commonly used for the direct comparison of diversity between two habitats. It compares how closely the species composition of two habitats matches an inventory of species. The Jaccard index is therefore similar to species richness indices, though it only takes species presence into account and does not incorporate species distribution or dominance. In addition to comparing spatially separated habitats, the Jaccard index and β -diversity may also be used to analyse the development of habitats over time.

β -diversity would be minimal, even in a mass extinction situation.

A useful tool for the comparison of different diversity indices is the number of taxa (assuming an evenly distributed community) corresponding to the respective index value, *i.e.* the number of taxa that would, given that all taxa have the same abundance, result in the respective index value. This equivalent number of species is also known as the 'true diversity'. It is not the diversity indices themselves, but rather, it is their equivalent number (true diversity), which follows the intuitive assumptions for diversity measures. Both the equivalent numbers for the Shannon index and for the Gini-Simpson-index would correctly reflect the above described fictitious extinction event.

α -diversity: punctual diversity, diversity in a habitat

β -diversity: difference between α - and γ -diversity, that part of γ -diversity (*i.e.* the diversity in a region) which is not part of α -diversity (*i.e.* the diversity of a certain habitat)

γ -diversity: regional diversity; diversity of a landscape

habitat: area inhabited by a particular species

true diversity: term describing the number of species that accord with a certain value of a biodiversity index when all species are distributed equally (*i.e.* when all species are equally abundant)

■ **See also:** Biodiversity indices: 3.1.4

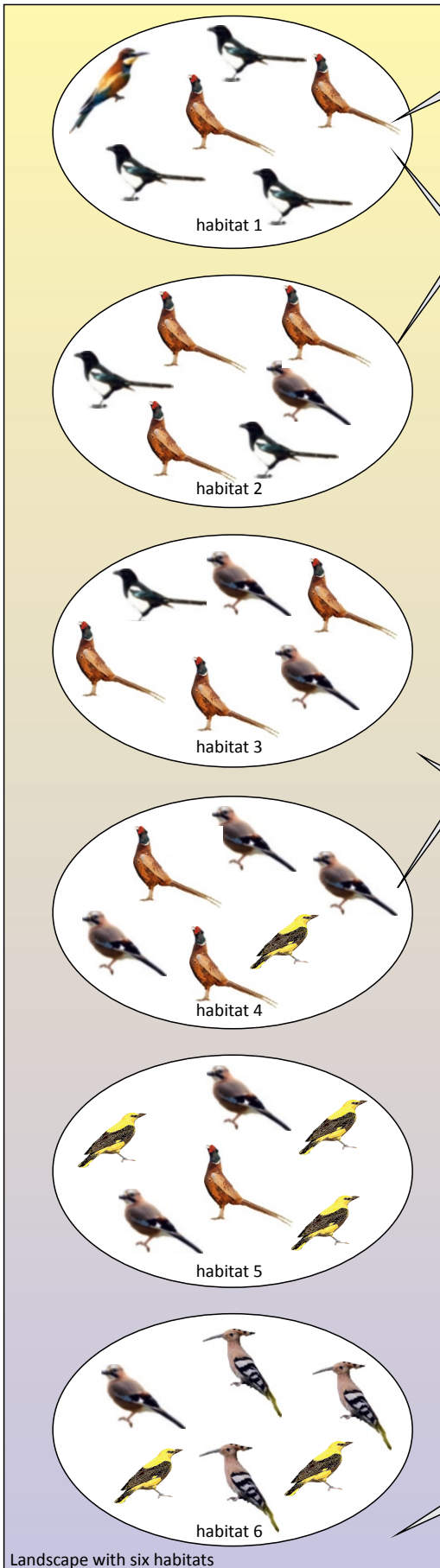

α -diversity describes biodiversity within a habitat. The most common index for α -diversity is the Shannon index, which incorporates the species richness and evenness of distribution of species. The α -diversity of this and other habitats represented here is the same (three species in an abundance ratio of 3:2:1). For each of the habitats the Shannon index is therefore 1.0 whereas the Gini-Simpson index is 0.61

Different indices are in use to compare the diversity between two habitats. The most commonly used indices relate species richness of discrete habitats (in this case, 3) to species common to both habitats (in this case, magpies and pheasants), and to species only occurring in one habitat (here bee-eaters in habitat 1 and jays in habitat 2). The Sørensen index (QS) is calculated as $QS = 2C/(A+B)$, where A represents the number of species in Habitat 1, B the number of species in Habitat 2, and C the number of species common to both habitats. In this example, $QS = 2 \times 2 / (3+3) = 4/6 = 0.66$. Similarly, the Jaccard index (J) is calculated as $J = C/(A+B-C)$. Here, $J = 2/(3+3-2) = 2/4 = 0.5$. Both indices only reflect presence-absence data, whereby the Sørensen index gives weight to species common to both habitats more heavily than does the Jaccard index. The Renkonen index, on the other hand, refers to species dominance between samples. For both samples, it adds together the lowest relative frequency value for all species. In this example, the Renkonen index can be calculated as $R_e = 0.33$ (at least 33 % magpies in both habitats) + 0.33 (at least 33 % pheasants in both habitats) + 0 (bee-eaters in only one habitat) + 0 (nutcrackers in only one habitat) = 0.66. Both of these measurements are taken into account by the Wainstein index (K_w), which measures the product of the Jaccard and Renkonen indices: $K_w = 0.5 \times 0.66 = 0.33$

β -diversity describes biodiversity between habitats. When habitats share a low number of species, β -diversity is high. In its original sense, β -diversity describes the ratio of species in a habitat (in this case, 3) to the total number of species across all habitats (here, 6). According to this definition, β -diversity is calculated as $(6/3=2)$ and represents the theoretical measure for how many habitats, with a mean species richness and without overlapping species, are needed in order to reach the total number of species across a landscape. In this example, two habitats each with three species were sufficient to uncover the total species richness of the landscape, i.e. pheasant, magpie, bee-eaters (corresponding to habitat 1) and hoopoe, oriole, and jay (corresponding to habitat 6). If one calculates the β -diversity as the difference between γ -diversity a α -diversity, the result for the Shannon index is a β -diversity of 0.6 ($H_\beta = H_\gamma - H_\alpha$, therefore $H_\beta = 1.6 - 1.0 = 0.6$; equivalent to 37 % of the γ -diversity) and for the Gini-Simpson index a β -diversity of 0.03 ($D_\beta = D_\gamma - D_\alpha$, therefore $D_\beta = 0.78 - 0.61 = 0.17$; equivalent to 21 % of the γ -diversity). In both cases, the β -diversity indices calculated here are a distorted measure of diversity. In contrast, if one calculates the β -diversity from true diversities (in other words, from the respective indices according to the corresponding number of uniformly distributed taxa), a different picture emerges: The true diversity is calculated for the Shannon index (H) as e^H , for the Gini-Simpson index (D) as $1/(1-D)$. Based on the Shannon index, the β -diversity is therefore $(e^{H_\gamma} - e^{H_\alpha})/e^{H_\gamma} = (5 - 2.7)/5 = 0.45$ (corresponding to 45 % of the γ -diversity). Based on the Gini-Simpson index, β -diversity is $[1/(1-D_\gamma) - 1/(1-D_\alpha)]/[1/(1-D_\gamma)] = (4.6 - 2.6)/4.6 = 0.44$ (corresponding to 44 % of γ -diversity). The results based on true diversity offer more realistic estimates of shifts in diversity compared to the respective underlying indices

The γ -diversity describes diversity within a landscape, integrating the α -diversities of the landscape's individual habitats. The spatial scale of relevant landscapes remains undefined and therefore a comparison of γ -diversities is often difficult. In general, the total species count (in this case, 6) serves as a basis, with common and rare species weighted differently depending on the approach. For the γ -diversity, the Shannon index is 1.6 and the Gini Simpson index is 0.78

Landscape with six habitats



Species concept limitations: viruses

■ Viruses are organic structures existing on the fringes of what constitutes life. They are non-cellular particles that multiply by infecting a host cell. Although viruses contain all of the necessary genetic information to code for their structure, they do not have their own metabolism and are unable to replicate independently without the metabolism of the host cell.

In their free form, viruses exist as virions after being discharged by host cells and spread into the environment. The envelope (capsid) of virions is mostly made of proteins or, as is the case with the influenza virus, of ribonucleic proteins. Capsids contain either RNA or DNA. Upon infection, virions either completely enter or release their nucleic acids into the host cell. The infected cell usually dies as soon as newly formed virions are released.

Viruses infecting bacteria or archaea are known as bacteriophages. Double-stranded DNA (DS-DNA) bacteriophages are usually larger than the mostly small and spherical

■ Viruses are the smallest known reproductive units, ranging from between 15 and several hundred nanometres in size. Although they display several characteristics of life, they are usually not considered to be alive including within NASA's official definition. Although viruses themselves do not metabolise, they are subjected to Darwinian evolution. Therefore, they share evolutionary properties with other forms of life, including splitting into independent phylogenetic lineages, and can be classified in the same way species can, though not in the traditional biological sense. The term

single-stranded DNA (ss-DNA) bacteriophages. RNA phages are among the smallest known bacteriophages, measuring only around 25 nm in size and usually consisting of a protein coat containing single-stranded RNA.

Around 3,000 types of viruses have been described so far, and likely several millions have yet to be discovered. It is assumed that each eukaryotic organism carries one or several host-specific viruses. The diversity of viruses and their ecological significance is potentially enormous. Aquatic habitats contain 10–100 times more viruses than they do bacteria, *i.e.* more than 100 million virions per ml. In sediment, the viral load can even be one or two orders of magnitude higher. A significant portion of the primary production in the sea is directly converted to viral biomass through viral infections of phytoplankton, or set free through cell lysis as dissolved carbon and then subsequently fed through the microbial food web.

'quasi-species' is often used for describing phylogenetically related virus populations.

Infectious genomes without capsids are called viroids. They often consist of an autocatalytic single-stranded RNA molecule (ribozyme). Unlike viruses, viroids, which exist predominantly in land plants such as potato, tomato, grapes, and citrus crops, have no additional proteins or lipids within the capsid.

The biology of infectious proteins, known as prions, remains virtually unknown, though these are important triggers of certain illnesses, such as Creutzfeldt-Jacob disease.

quasispecies (viral): a group of virus genotypes which have resulted from the same viral genome in a host

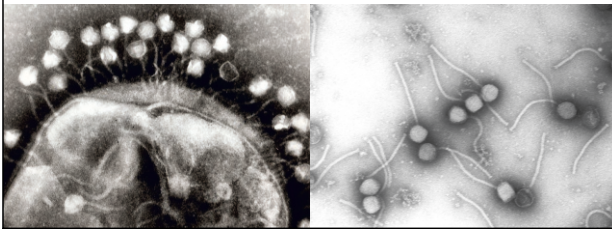
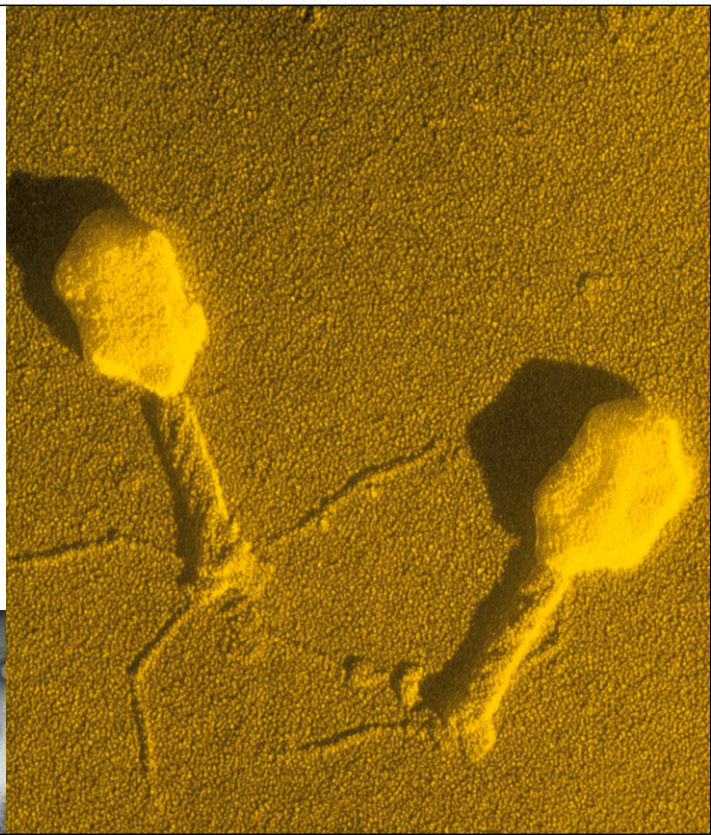
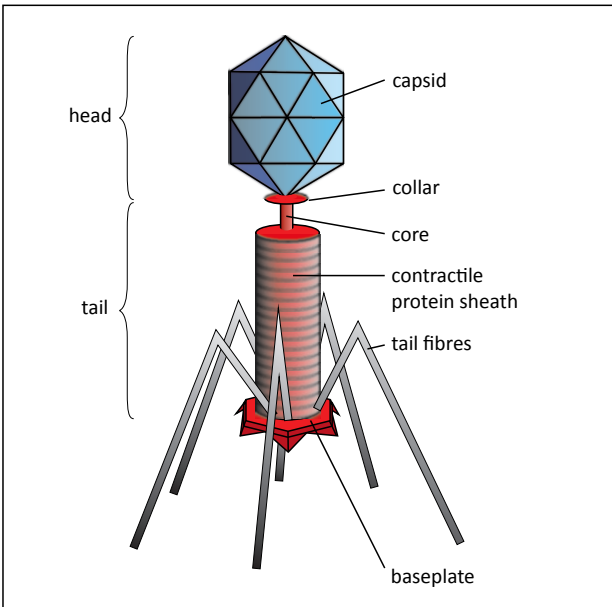

Bacteriophages: diagram and electron micrograph of different phages

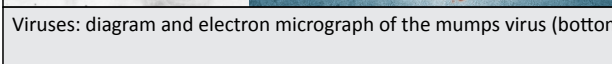
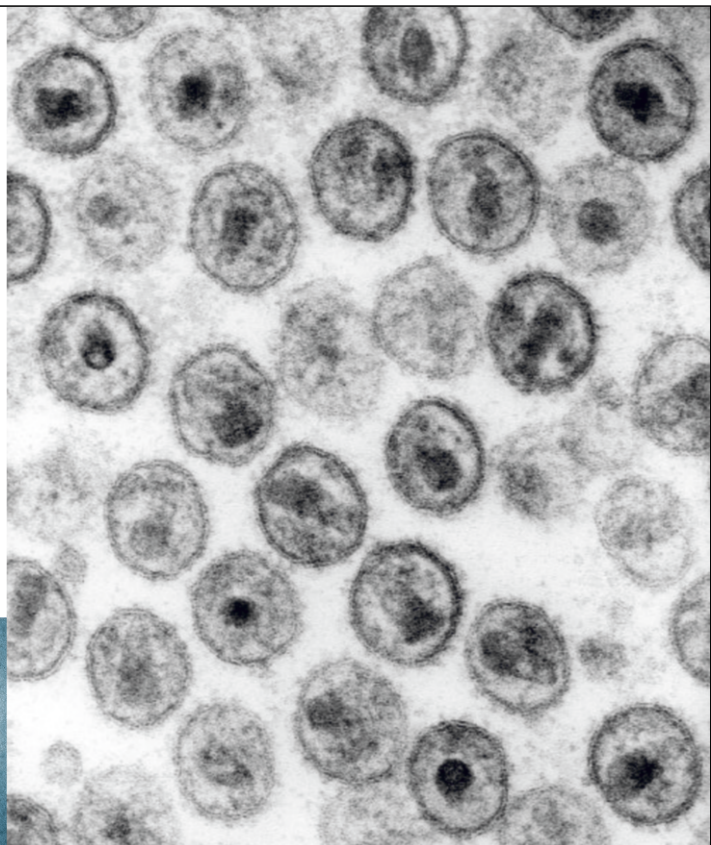
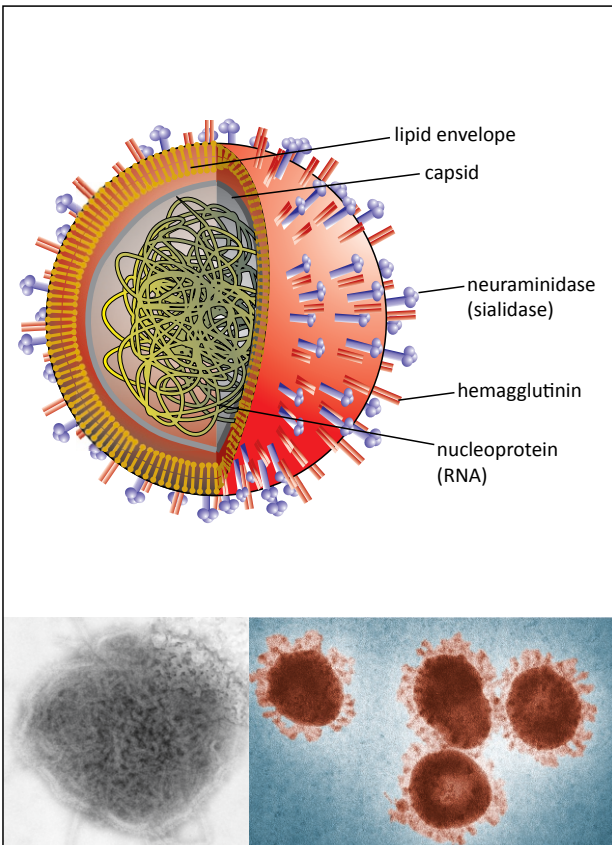

Viruses: diagram and electron micrograph of the mumps virus (bottom-left), coronavirus (bottom-middle), and HIV (right)



Species concept limitations: lichen

■ Lichens are the product of a symbiosis between mycobionts (fungi) and a photobiont. The fungal component is usually a member of the Basidiomycota or sometimes of the Ascomycota. The photobiont is either a green algae (Chlorophyta), referred to as a phytobiont, or a cyanobacterium, known as a cyanobiont. There are around 25,000 known lichen species.

Although lichens are comprised of one fungal species, they can be made up of several phytobionts or cyanobionts, though these rarely co-occur within the same lichen. Algae may be grouped either in one layer (heteromeric) or may be evenly distributed (homomeric).

Lichens are named according to the mycobiont they contain. The mycobiont is often reliant on the symbiosis for life, whereas phytobionts or cyanobionts are typically able to sustain themselves outside the partnership. Carbohydrates and other nutrients supplied from the photobiont power the mycobiont. The symbiotic advantage for algae is less clear, however, though as a result of the mycobionts, the algae are protected from UV-radiation and desiccation. In any case, as the mycobionts seem to gain more from the symbiotic

■ Lichens face an exceptional reproductive challenge, since both symbiotic partners must be simultaneously distributed into the environment. For the most part, propagation is vegetative, in other words, asexual and with only one plant involved and the offspring resulting from just one parent. Either the fragments of the thallus or special structures, the isidia or soredies, are distributed.

Isidia are growths emanating from the thallus (often as needles or scales) that break off and then are passively disseminated. Within the isidia are photobionts surrounded by a shell of hyphae.

relationship, the mycobiont-photobiont interaction is often known as 'controlled parasitism'.

Basic properties of lichens, such as growth patterns and the formation of characteristic acids, differ so widely from those of their constituent partners that they appear as distinctive organisms. Lichens are distinguished from each other according to their shape and surface patterns: fruticose, foliose, crustose, leprose and gelatinose. This subdivision does not correspond, to phylogenetic relations.

Crustose lichens are firmly anchored to the substrate by their underside. Fruticose lichens have narrow ramifications and specific stabilising elements. Gelatinous lichens swell when they absorb water and shrink together when under dry circumstances. The lichen leaf or leaves are often only loosely attached to the base of the organism, or with adhesive organs (rhizines). Their thallus is lobed and erect.

Lichens colonise different locations and materials, including tree bark, soil, and the surface of rocks. Since they are highly tolerant to cold, heat, and desiccation, they are also found in extreme environments, including in Antarctica.

Soredia are small structures consisting of one to several photobionts, closely surrounded by hyphae. They are formed in soralia and are actively emitted by the thallus and spread by wind.

Within the lichen, only the mycobiont can reproduce independently by forming characteristic fruiting bodies (apothecia) containing sporangia. The sporangia release the meiospores on their upper surface or on the edge of the thallus. Conidia, which are non-motile spores, make lichens capable of asexual reproduction. However, new lichens can only arise when new hyphae are combined with the appropriate photobionts, a process known as lichenification.

thallus: multicellular undifferentiated vegetative tissue in plants, algae and fungi without the organisation of a cormus (sections incl. stem, root, and leaf)



Rocella fuciformis is a fruticose lichen with a shaggy thallus. It grows from the tips of individual branches. *Rocella* is the source of the blue-violet dye litmus



Rhizocarpon geographicum is a crustose lichen. Its thallus grows close to the ground, or it can grow through the ground. This type of lichen can live to over 1,000 years of age, and can therefore be used for dating the retreat of the ice cover (glaciers)

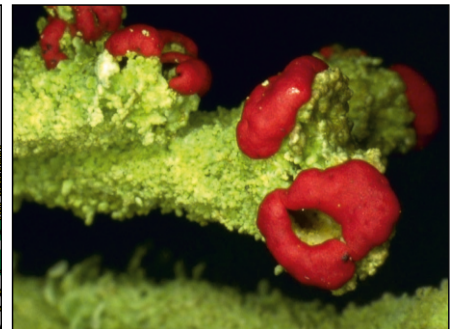
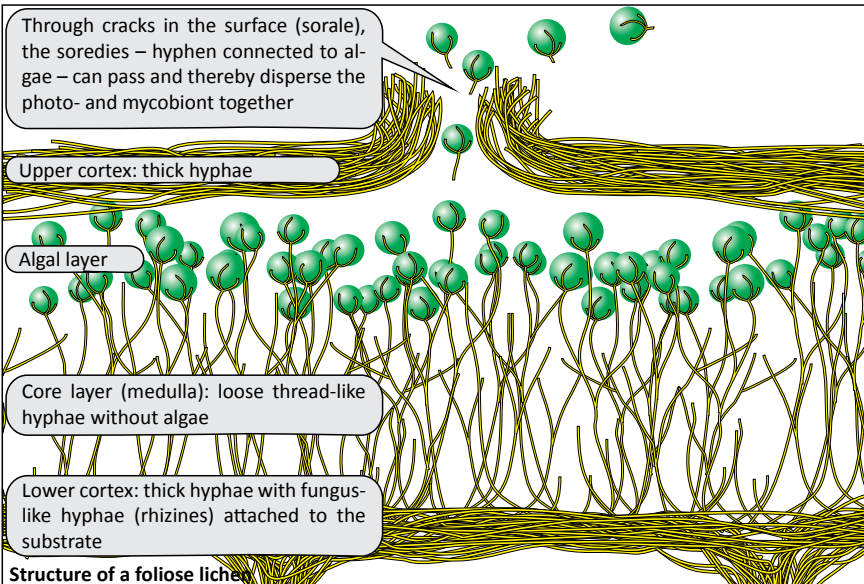

Photobionts reproduce only asexually by division, while mycobionts can also reproduce sexually, forming apothecia or perithecia where fungal spores form (apothecia of *Cladonia* sp., top). During the germination of the spores, the fungi again form a symbiosis with a suitable photobiont (phytobiont or cyanobiont)



Collema nigrescens is a gelatinous lichen, and the photobiont of gelatinous lichens are cyanobacteria. Upon humidification, the lichens swell, like gelatine. They are usually blackish or dark olive green



Xanthoria ectaneoides is a foliose lichen with flat leaves that lies along the substrate. The sheet-like shape of the leaves optimises photosynthesis of the photobiont



Biodiversity distribution

Life is unevenly distributed, primarily as a result of climate as well as Earth history, specifically plate tectonics. Biodiversity generally increases nearer the tropics, since temperature and precipitation play key roles. The distribution of the predominant life forms is particularly apparent when one compares different biogeographical, or ecological

The historical drivers of present-day biodiversity relate primarily to the physical connections between continents. These explain distribution patterns mostly at the level of phylogenetic groups (genera, families, orders).

Climatic factors, on the other hand, explain current distribution patterns and the dominant life forms within a region. For example, the availability of water allows for the development of rich vegetation: Forests dominate in areas of normal-to-high precipitation in both tropical (tropical rain forests) and temperate (deciduous and boreal coniferous forests) climatic zones, whereas grasslands dominate regions of lower water availability.

In subtropical and tropical regions, water availability is linked to overall precipitation and to seasonal fluctuations. Savannas are found in the transition zones between the humid tropics and arid, subtropical deserts.

regions. Various phylogenetic groups are generally limited to particular ranges of distribution, determined by recent and historical barriers.

These patterns are particularly striking in land plants and animals; their applicability to other organisms, especially microorganisms, remains unclear.

Precipitation is a central factor in determining species distributions in temperate areas as well, for example in inland areas or in the wind shadow zones of mountains. In cooler regions, temperature is also an important climatic factor determining the distribution of species. For example, water is unavailable during periods of frost, even when precipitation is high.

Similarly, deserts prevail in areas of even lower water availability, leaving them with little or no vegetation cover.

Climatic conditions and their effect on vegetation are also of central importance to the distribution of animals. For example, large migratory herds of herbivores and small ground-dwellers tend to dominate seasonally dry grasslands. The former migrate large distances to avoid adverse climatic conditions, whereas the latter have either seasonal resting phases and/or stockpile food, in response to these seasons.

biodiversity: (definition given by the UN Convention on Biological Diversity) the variability among living organisms from all sources including, inter alia, terrestrial, marine and other aquatic ecosystems and the ecological complexes of which they are a part; this includes diversity within species (genetic diversity), between species (diversity of species) and of ecosystems (and the interactions contained within them)

ecoregion: a relatively large area of the earth's surface 'containing a geographically distinct assemblage of species, natural com-

munities, and environmental conditions' (WWF definition); the term 'ecoregion' was originally used in the context of geographical scholarship (meaning a 'recurring pattern of ecosystems associated with characteristic combinations of soil and landform that characterize that region')

life form: integrates organisms with a similar morphological structure and way of life; term most frequently used in botany

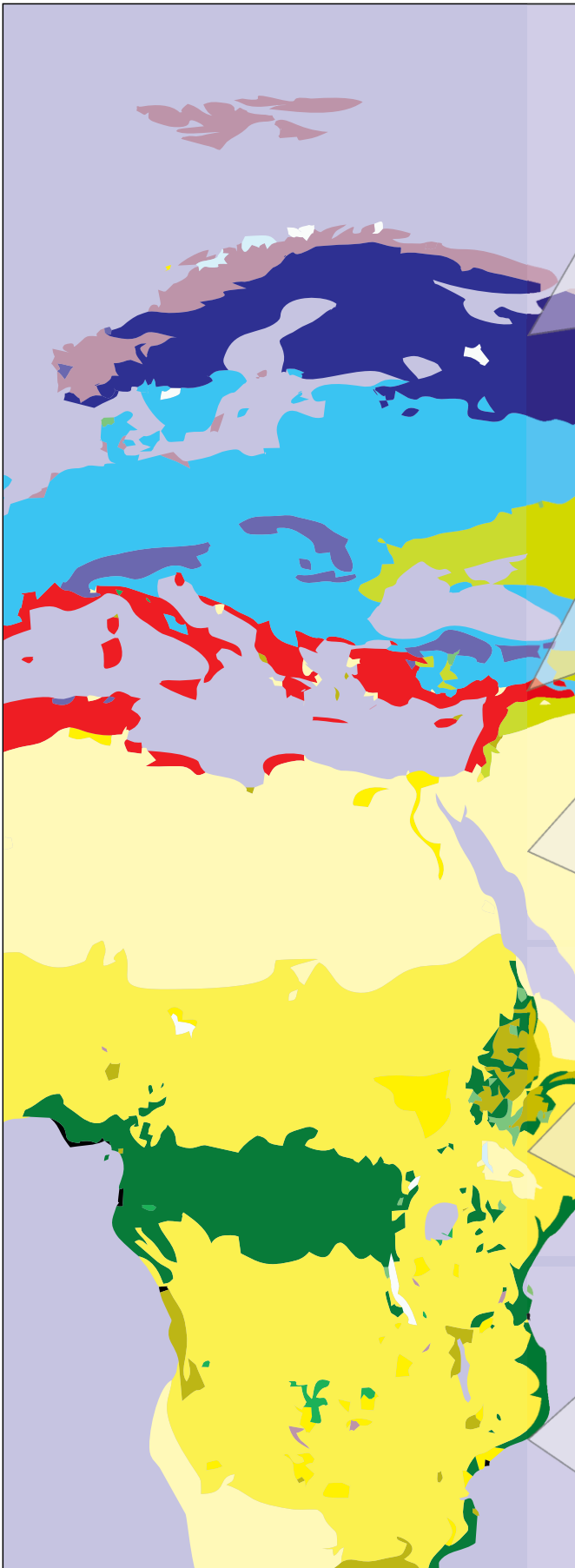

Taiga



Mediterranean biome



Desert



Savannah



Rainforest and mangrove





Patterns and mechanisms

Two million different species have been described so far, of which roughly 80% are terrestrial and the remaining 20% are aquatic.

There are approximately 61,000 described vertebrates (of which half are fish), 1,260,000 invertebrates and 290,000 land plants. Far fewer fungal (72,000), protist (78,000), and prokaryotic (8,000) species have been described.

The vast majority of Earth's species are thought to be still unknown or uncharacterised. To that end, it is assumed that

Estimates for global biodiversity range from around 3.5 million to more than 100 million species. These predictions are based on extrapolations of known biodiversity, making use of a number of different calculations.

For example, based on the number of extant insect species found on any given host plant, the total number of insects can be estimated based on the number of known plant species. However, such estimates rely on a profound knowledge of host specificity; since knowledge in this field is not precise, strongly diverging estimates can be found.

Other approaches estimate global biodiversity on the basis of regional diversity in well-studied regions; for example, can be estimated a global number of fungal species based on the relatively well-known number of fungal species found on the British Isles.

Other approaches are founded on the assumption that the ratio of species richness between different groups of organisms is similar across different geographic regions. Based on this assumption, the global biodiversity of various groups of organisms can be extrapolated from the relative diversity of these organisms at one location. Total diversity can be estimated starting from a well-studied region and at thus one globally studied organismal group.

A very different approach attempts to estimate total species diversity using the rate at which new species are described. Decreasing numbers of new taxa discoveries, for example, would indicate that most of these groups of organisms have already been described. By extrapolating the num-

around 85% of vertebrates, 65% of land plants and 25% of invertebrates have been described. Moreover, under 10% of planet's microorganism groups are thought to have been described.

Based on what is known so far, the estimated number of total species on Earth is thus around 71,000 vertebrates, 5.5 million invertebrates, 440,000 land plants, 1.5 million fungi, 800,000 protists, and over a million prokaryotes.

ber of newly described species, the total number of species could be estimated.

The number of higher eukaryotes in the wild is probably 5–10 million, although this estimate could double if it included parasites which remain under-studied. Similarly, it is not possible to make a plausible estimate of the total diversity of eukaryotic and prokaryotic microorganisms.

For a number of reasons, even the total number of described species can only be estimated: firstly, many species have been described multiple times, leading to the simultaneous usage of synonymous names until taxonomic revisions eliminate all but one of them. Secondly, many species descriptions are taxonomically invalid. Thirdly, particularly older descriptions were based on poor methodology in comparison to modern techniques; it is often difficult to clarify to which type species these descriptions refer. Furthermore, some 'species' are in fact species complexes rather than individuals, comprising morphologically similar but inaccurately delineated species.

Finally, the uncertainty behind the estimation of the number of known species stems from differences in rules for species description between relevant disciplines (zoology, botany, microbiology, etc.). For example, several protist species have been independently characterized both using the zoological and botanical codes. The variety of species concepts existing between disciplines results in widely different species definitions and, ultimately, in a variety of often conflicting species descriptions.

extrapolation: process of estimating variables outside a given interval based on the known variables inside the interval



| Taxon | Described species | Estimated number of total species | |
|-----------------------|-------------------|-----------------------------------|--|
| vertebrates | 60,979 | 71,000 | The diversity of vertebrates is well known. To date, over 85% of species are estimated to have been described |
| mammals | 5,416 | 5,500 | |
| birds | 9,917 | 10,000 | |
| reptiles | 8,300 | 10,000 | |
| amphibians | 5,743 | 7,500 | |
| fish | 28,900 | 35,000 | |
| invertebrates | 1,263,700 | 5,500,000 | The number of existing invertebrate species, especially insects, is very high. Although more species of insects have been described than of any other group of organisms, only about a quarter of insects are thought to have been recorded thus far |
| insects | 950,000 | 4,000,000 | |
| other arthropods | 150,000 | 635,000 | |
| molluscs | 70,000 | 120,000 | |
| nematodes | 25,000 | 500,000 | |
| platyhelminths | 20,000 | 80,000 | |
| land plants | 289,000 | 444,000 | The diversity of land plants is well known. An estimated two-thirds of land plant species have been described thus far |
| bryophytes | 16,600 | 22,000 | |
| ferns and club mosses | 12,838 | 15,000 | |
| gymnosperms | 930 | 1,000 | |
| angiosperms | 258,650 | 320,000 | |
| lichen | 17,000 | 25,000 | Fungi, protists (including algae), prokaryotes and viruses are relatively poorly understood. Only a few percent of estimated totals have been described, and the current estimated number of microorganism species many even be too low by several orders of magnitude. Analyses of molecular diversity, based on high-throughput sequences of environmental samples, indicate a potentially enormous diversity of these organisms |
| fungi | 72,000 | 1,500,000 | |
| protists | 77,540 | 800,000 | |
| prokaryotes | 7,793 | 1,000,000 | |
| viruses | 2,000 | 400,000 | |
| | | | |

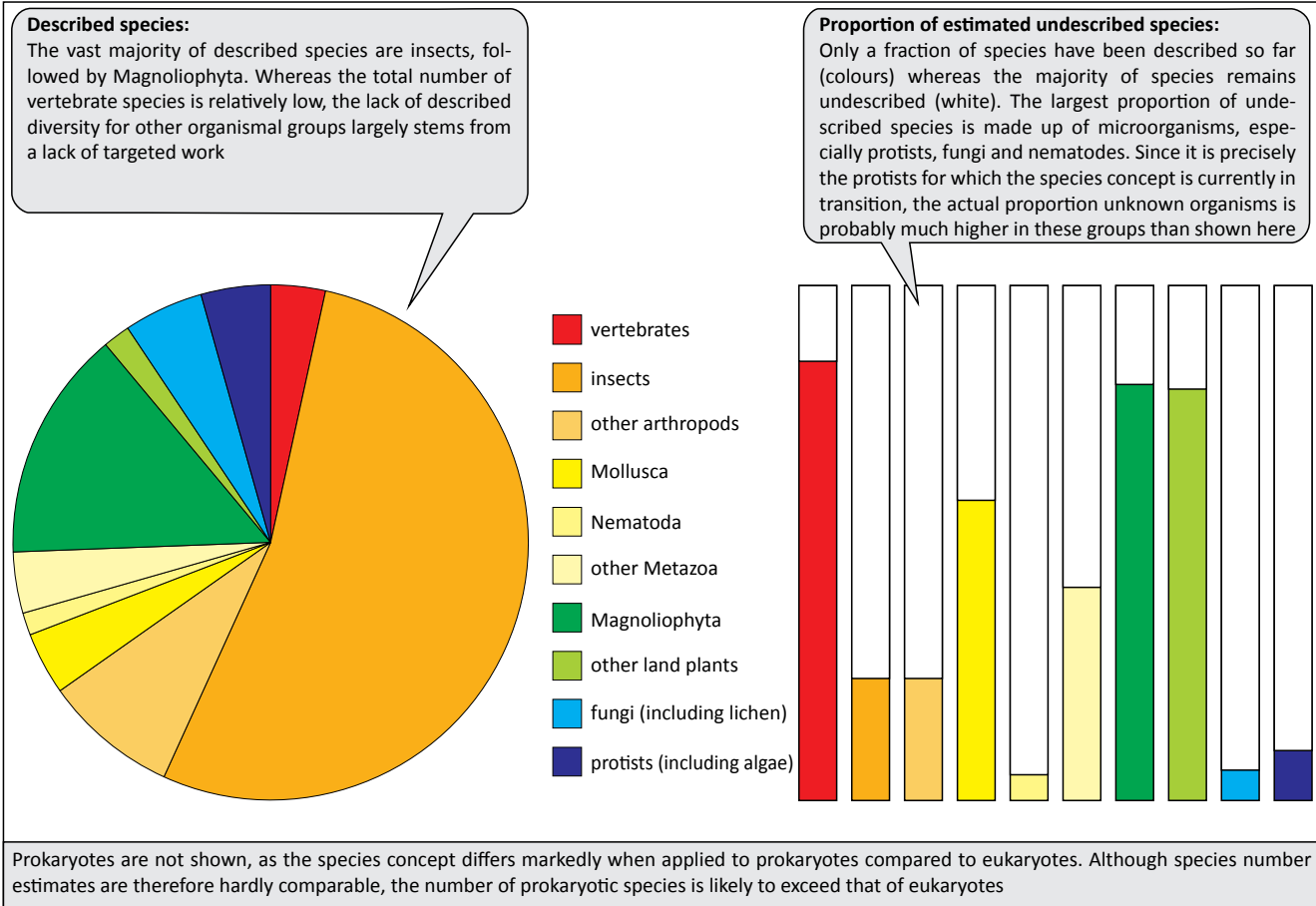



Biodiversity hotspots

■ Biodiversity on Earth is unevenly distributed: Some areas are particularly species-rich ('hotspots') whereas other areas are populated by relatively few species ('coldspots').

The estimate of biodiversity in a region usually hinges on one or a few organismal groups, often land plants or vertebrates. Plants and vertebrates often have a higher biodiversity in tropical or subtropical regions. For plants, the southern tip of Africa is particularly rich in endemic species, anchoring the biodiversity of the wider region. Biodiversity hotspots

■ According to the original definition, biodiversity hotspots are regions in which large numbers of endemic plant species can be found and whose habitats are particularly vulnerable. Specifically, a hotspot was defined as an area where at least 1,500 endemic vascular plant species (*i.e.* at least 0.5% of total described species) could be found and where a loss of at least 70% of the primary vegetation is known to have taken place. Most regions that meet these criteria are tropical or subtropical habitats, together comprising less than 2.5% of the total land area on Earth yet accommodating over half of all known vascular plant species.

It is notable that, in this definition of the term, the level of threat to organisms plays a central role; in other words,

and coldspots are not necessarily the same across organismal groups: for example, the southern tip of Africa, rich in plant diversity, does not contain particularly many vertebrate species.

Most organisms are not included when hotspots are being considered; it is thus unknown whether or not the areas which have been determined to be plant or vertebrate hotspots are also particularly rich in fungal, protist, or prokaryotic diversity.

biodiversity hotspots are not just areas of high biodiversity, but are also home to particularly endangered organisms. The idea behind this definition had to do with species conservation, *i.e.* the aim of protecting as many organisms as possible at the lowest possible cost.

This approach is controversial for a number of reasons, not least that it presents a biodiversity analysis with the (political) goal of cost-effective species protection rather than strategic conservation of the most ecologically important species. In addition, it also defines target regions for protection based only on a few organismal groups, thought to be indicators of general biodiversity health.

endemic: occurrence of organisms within a defined restricted geographical area

floristic kingdom: biogeographical region that differs markedly from other regions due to its endemic floristic taxa

■ **See also:** Mediterranean biome: 3.2.2.8; Rainforest: 3.2.2.11

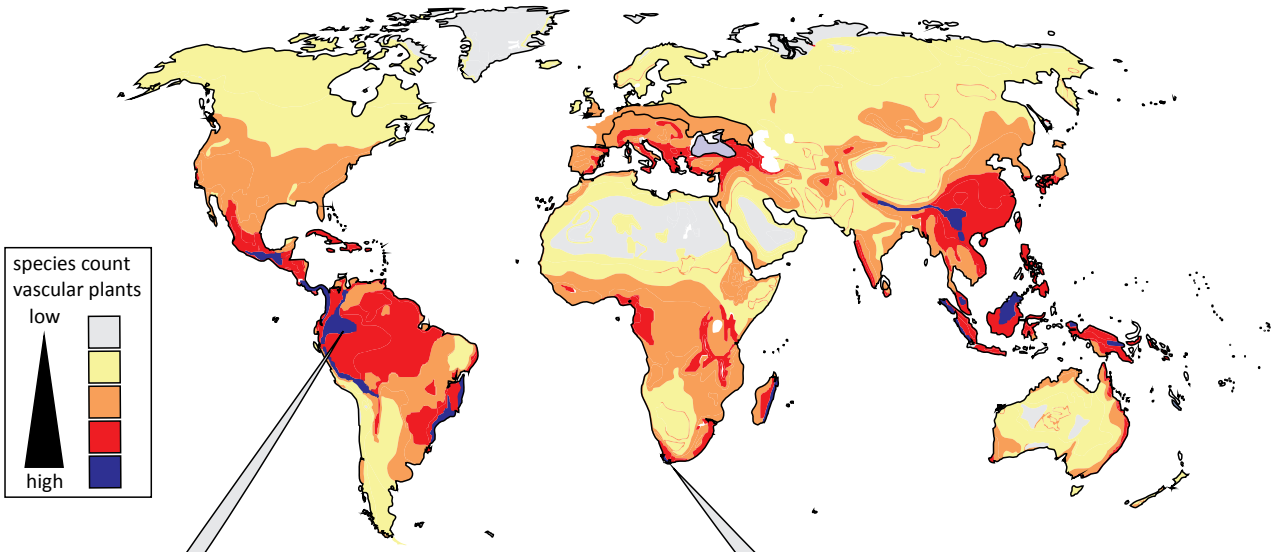

Tropical rainforests, especially the Amazon basin, are characterised by a high diversity and an abundance of endemic animal and plant species



The Cape flora is isolated from the rest of the African continent by dry areas (Kalahari and Namib deserts) and has many endemic species



A high fish diversity developed in Lake Malawi (top) and in the other Rift Valley lakes of East Africa

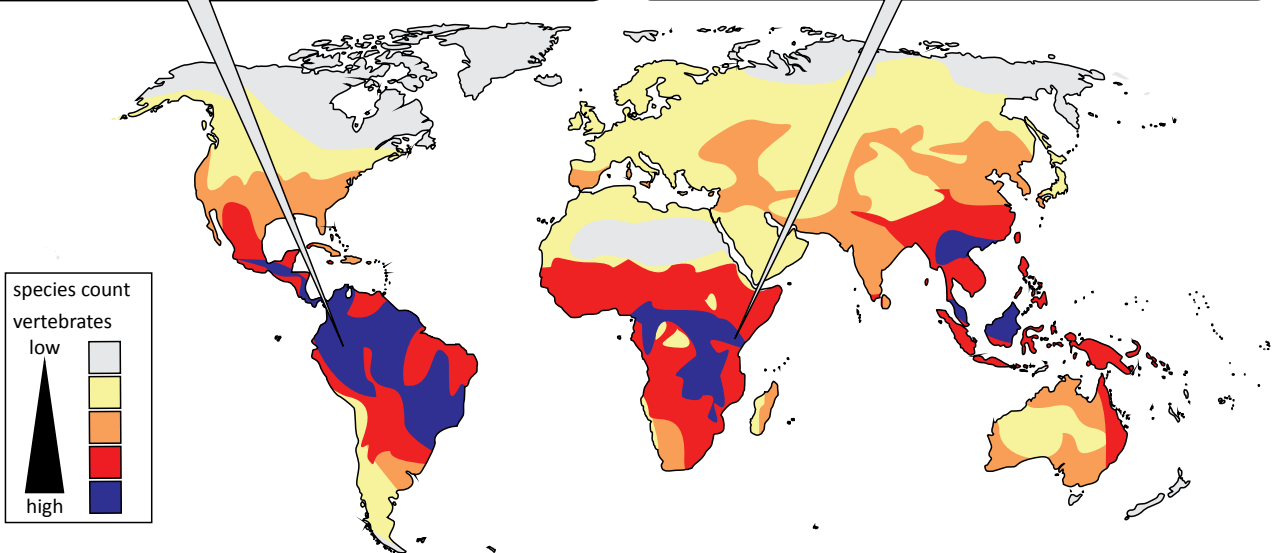



Ecological niches

■ The coexistence of multiple species – the basis of biodiversity – raises many questions. Different species often require the same resources and compete for them, raising the fundamental question of how coexistence is even possible. Why does the ability of one species to efficiently use a distinct resource not lead to the extinction of other species? The principle of competitive exclusion is founded on the argument that two species with the same ecological requirements (*i.e.* identical ecological niches) cannot coexist in the same environment, eventually leading to the extinction of one of these species.

The ‘fundamental niche’ of a species is a theoretical niche based on the genetic variability and norm of reaction of that species, *i.e.* the range of abiotic and biotic environmental conditions under which the species could in theory survive (including in the laboratory). In contrast, the ‘realised niche’ refers to the part of the fundamental niche that is actually used. Competition with other species leads to a reduction of

■ The apparent coexistence of many species in structurally poor habitats, such as the many species of phytoplankton in a lake, appears to contradict the fundamental premises of the niche concept. This contradiction was formulated as the ‘paradox of the plankton’: how can coexistence occur when so many different planktonic species depend on the same resources and light? There are various possible explanations for this paradox. For one, based on the niche concept, one could argue that there are simply not enough factors included in an analysis of any given habitat, and that each habitat is actually comprised of many more niches than was previously thought. Alternatively, it is conceivable that simply the presence of new species creates new niches. Finally, it is also conceivable that several species occupy the same niche and can coexist within that niche.

The ‘intermediate disturbance hypothesis’ postulates that coexistence is possible at a medium frequency of disturbance in the habitat. According to this hypothesis, undisturbed habitats are dominated by a specialist species and are relatively species-poor. Conversely, in highly disturbed habitats, *i.e.* those altered regularly by climate change or human activity, only species that are adapted to frequent change can survive; therefore these habitats also have relatively few species. In contrast, habitats with a medium level of habitat disturbance

the realised compared with the fundamental niche. Mutualistic relationships, however, can lead to an increase in niche size.

Species coexistence is possible when species use resources differentially well, and when each species is better able to cope with a particular set of environmental conditions than the other species. Spatial ecological niches and temporal factors such as seasonality also enable coexistence between species with similar ecological requirements in the same habitat. In general, species are only well adapted to certain combinations of environmental factors; biotic interactions further modify these interactions. Predation pressure can sometimes alter the basic dynamics of an ecosystem. For example, relatively weaker prey species populations may benefit from increased predation pressure on otherwise stronger prey species. Predation can also reduce the abundance of prey organisms to the extent that competition between prey species disappears.

have a relatively high diversity of species: some species are adapted to stable conditions but can also survive at levels of medium environmental disturbance, whilst others, adapted to more frequent disturbance or to primary succession, will also survive. A moderate frequency of disturbance thus creates a dynamic temporal habitat, which promotes each species at a different time. The conditions in such habitats do not last for long, so species which are not well adapted to a particular change do not die out completely.

The ‘neutral theory’ is an alternative, more controversial explanation for coexistence. According to the neutral theory, species may coexist even in entirely overlapping niches; niche differentiation and competition play no role in coexistence. According to this, abundance curves are stochastically explained: speciation and extinction are based solely on random processes. On the basis of such simple assumptions, abundance curves typical for many habitats (*i.e.* with few common and many rare species) can be modelled. Which species end up being common is purely coincidental. The fact that certain species occur and dominate in different habitats contradicts this theory. Although the neutral theory therefore cannot explain observed distribution patterns, it contributes to the debate by recognising of stochastic elements into niche theory.

norm of reaction: width of phenotypic variation which can develop from a distinct genotype

primary succession: plant life occurring on substrate devoid of vegetation or on newly formed substrate

■ **See also:** Species concept: 3.1.2

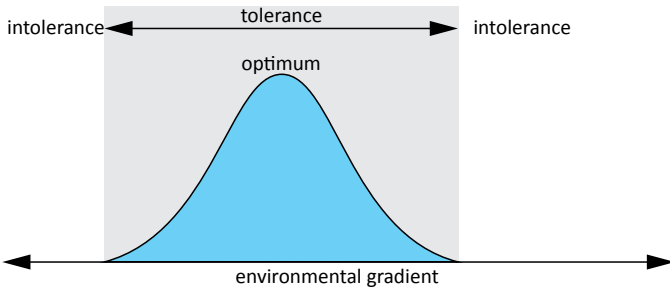

The fundamental niche of a species is defined as the range of an environmental gradient in which it could live. To that end the niche space refers to the area in which a species could live across multiple environmental gradients

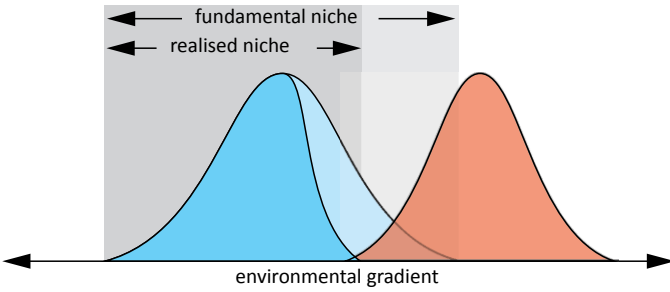

The realised niche is the portion of the fundamental niche within a particular ecosystem that is occupied by the species in question. By overlapping the fundamental niches of a number of species you shrink their realised niches. Mutualistic relationships, however, may extend the realised niche area

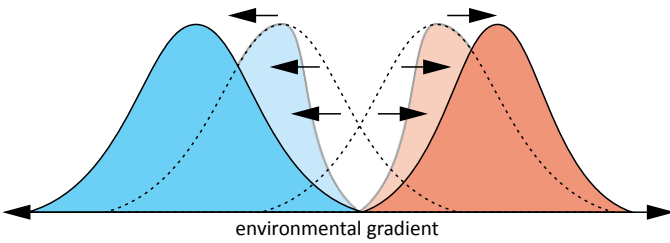

Competition with other species, or even competition between isolated populations of the same spaces, leads to niche differentiation. If certain areas of the fundamental niche are not used due to competitive relationships, that fundamental niche may shift and species may lose the ability to live under those conditions. At the same time, the fundamental niche may expand in other directions

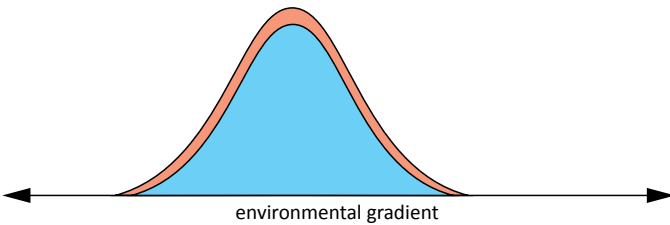

Two different species sharing ecological niches compete with each other, which may lead to the extinction of one species through competitive exclusion, particularly if that species cannot occupy a different niche (competitive exclusion)

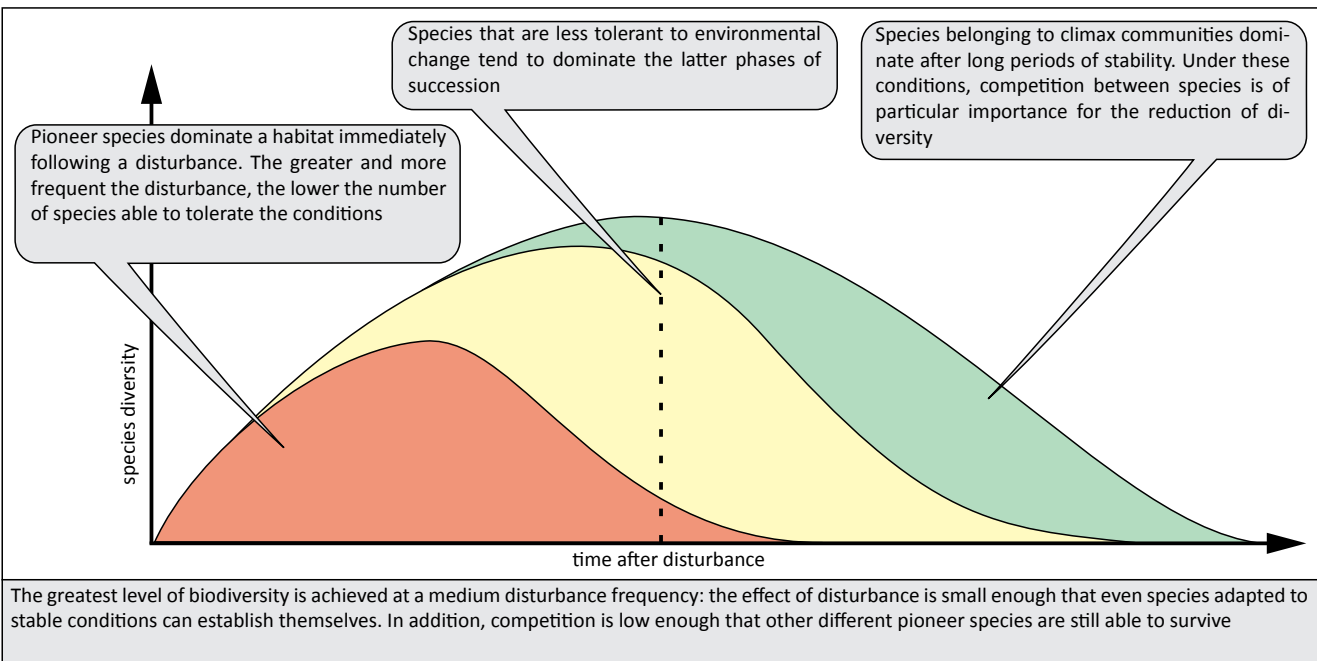

The greatest level of biodiversity is achieved at a medium disturbance frequency: the effect of disturbance is small enough that even species adapted to stable conditions can establish themselves. In addition, competition is low enough that other different pioneer species are still able to survive



Speciation mechanisms

■ Speciation, *i.e.* the differentiation of one species into two new ones, is preceded by separating gen pools of two sub-populations of the parent species. In principle, at least for biological species and for species that reproduce sexually, genetic material is exchanged and recombined between individuals of a population. The gene frequencies within a gene pool can shift within a population, but they stay homogeneously mixed between individuals.

Speciation involves the divergence of the gene pool into two sub-populations of the ancestral species. Speciation occurs as a result of an increasing divergence between the gene pools of separate populations of a species. When the exchange of genetic material between separate populations slows or is interrupted completely, these populations diverge further from each other with each generation. Random mutations and sometimes also adaptive mutations decrease further the genetic similarity between populations. The populations also increasingly differ phenotypically (*i.e.* in their appearance and metabolism). Finally, individuals from the diverging populations develop incompatible reproductive organs or incompatible genetic mechanisms of reproduction (number of chromosomes, meiosis) and thus become repro-

■ Reproductive isolation is achieved via several different mechanisms apart in addition to sexual incompatibility. These can be understood as either pre-zygotic or post-zygotic mechanisms.

Pre-zygotic isolation mechanisms occur before fertilisation and thus prevent the formation of a zygote. One such mechanism is gamete incompatibility, where copulation (or pollination in plants) occurs, but not fertilization. For example, either the pollen tubes are incompatible (plants) or sperm are wrongly adapted (animals). Other examples of pre-zygotic isolation mechanisms are sexual selection and spatial or temporal niche differentiation.

ductively isolated. Ecological niche separation may, also eventually lead to reproductive isolation.

The isolation of two populations of the same species can occur as a result of geographic barriers, such as oceans or mountains, but also as a result of climatic or geological factors, or by human intervention. These mechanisms of species differentiation by geographic isolation are referred to as allopatric speciation.

Speciation can also occur without spatial isolation. This type of speciation is referred to as sympatric speciation. However, certain mechanisms of selection must take effect in order for the gene pool to diverge without spatial separation. For example, this can occur as a result of disruptive selection, or diversifying selection, when extreme values for a trait are favored over intermediate values so that the variance of the trait increases and the population is divided into two distinct groups. Assortative mating, *i.e.* mating between individuals which are particularly similar in certain traits, is an example of disruptive selection. Parapatric speciation refers to a situation in which populations are either temporarily separated or live in separate but slightly overlapping areas.

Post-zygotic isolation mechanisms refer to those that occur after the formation of a hybrid zygote, which however, is usually either not viable or is sterile. When such hybrids are viable and fertile, they become reproductively isolated because they may have a lower ecological fitness.

Sudden isolation mechanisms, occurring within a single generation, are also known to exist. In plants, polyploidisation, or the multiplication of chromosome sets per cell, can cause immediate reproductive isolation. Similarly, a complete reproductive isolation condition also occurs in insects, for example, through infection by incompatible, endosymbiotic bacteria (especially of the genus *Wolbachia*).

adaptive mutation: mutation resulting in improved adaptation
ecological fitness: adaptation of an individual to its environment
endosymbiotic bacteria: symbiotic bacteria living in other organisms

fertility: the ability to produce offspring
hybrid: (Lat.: *hybrid* = mixture) offspring resulting from cross breeding by parents of different species
infertility: the inability to produce offspring



The collision of North and South America and the raising of the Panama land bridge approximately 3.5 million years ago interrupted the connection between the Pacific and Atlantic oceans. The populations of different marine species were thus reproductively isolated and subsequently developed separately. This formation of new species by geographic separation is called allopatric speciation



Atlantic: *Anisotremus virginicus* (Virginia porkfish)

Pacific: *Anisotremus taeniatus* (Panama porkfish)

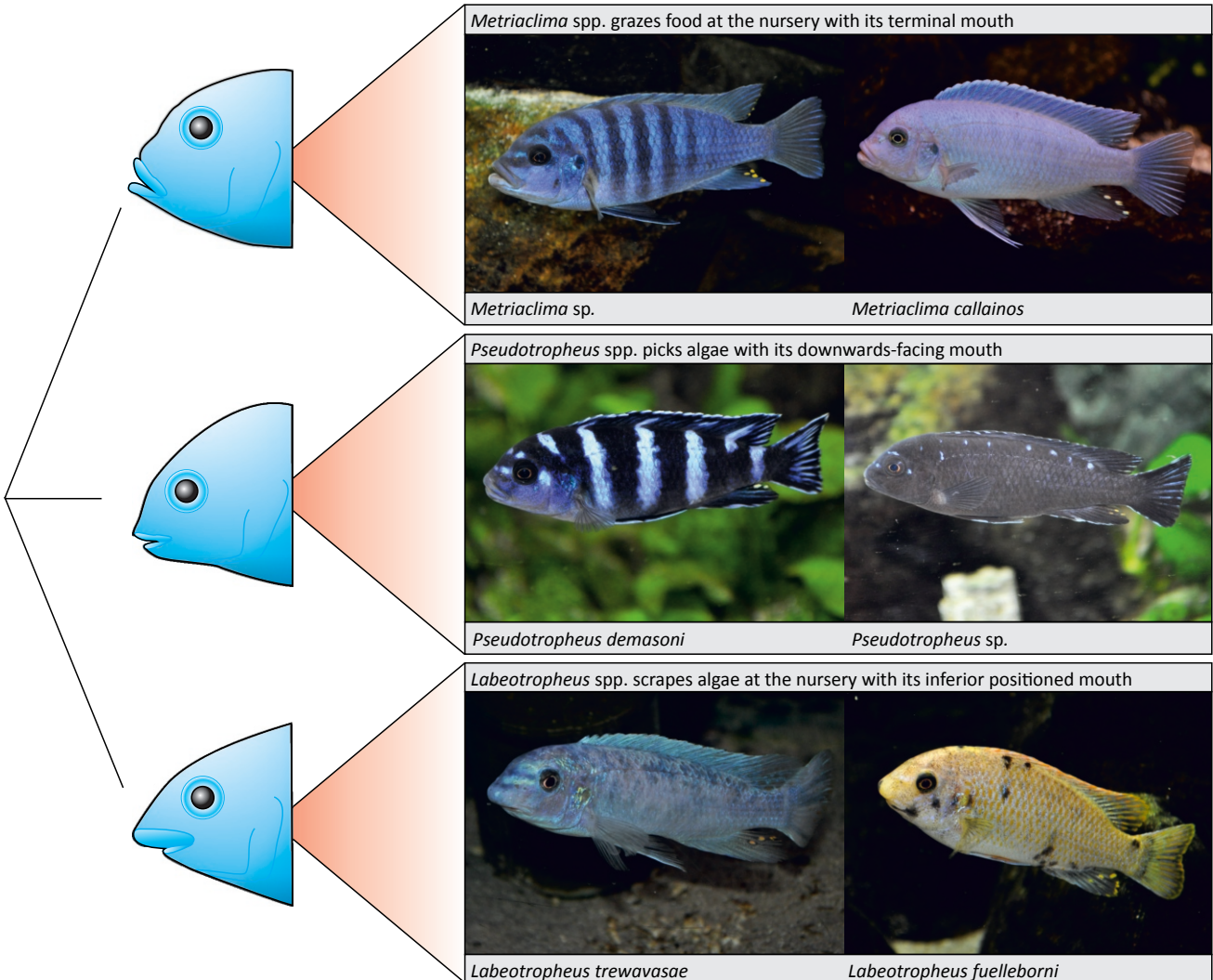
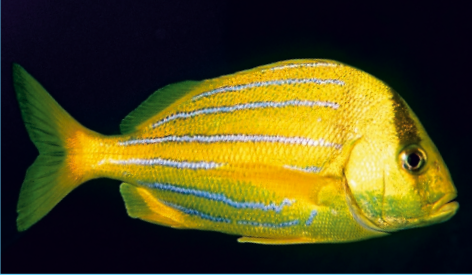

The diversity of cichlids in Lake Malawi has emerged through successive radiations. Those found in rock biotopes (Mbuna) are characterized by a mode of nutrition suitable to that way of life, including a different mouth position. Subsequently within each genus different colorations have evolved and radiated. Sympatric speciation occurred by assortative mating (i.e. sexual selection); in other words, through speciation without the geographical separation of populations



Island biogeography

■ Island biogeography theory is concerned with the relationship between species extinction and range extension for the creation of stable species richness. It is therefore not necessarily restricted to islands, although these are the natural testing grounds for the theory as they present clearly distinguishable habitat partitions placed at definable intervals. Thus, the significance of the geographic barriers can easily be characterised. Island biogeography theories generally focus on the importance of geographical barriers, including isolated marine and freshwater habitats, forests, mountain ranges, or valleys. According to these theories, 'islands' are any habitat surrounded by other types of habitats. This general definition makes it easy to understand that the degree of isolation of any particular habitat, caused by a geographical barrier, is not the same for different groups of organisms. This is of course also true for real islands: for example, birds

■ The species richness of islands is determined by the immigration of new species, the extinction of existing species, and by the speciation processes. Species immigration rates depend on the accessibility of the isolated habitat ('island') from other populations: Factors which affect these rates are thus abiotic factors such as the distance between the habitats, the wind direction and the strength of ocean currents. The extinction rates of species living on an island depend on the size of the habitat: the larger the island, the larger each distinct habitat can be and, therefore, the greater the habitat heterogeneity. Greater habitat heterogeneity allows more species, with a broader range of ecological requirements, to survive, and the larger habitat area permits larger and thus more stable populations. When species immigration rates are higher than extinction rates, biodiversity increases. When

are better able to reach individual islands than are mammals or reptiles.

A fundamental principle of island biogeography is that larger islands are inhabited by a greater number of species than are smaller ones. Similarly, islands lying close to other landmasses are richer in species number than more isolated islands. These principles of island biogeography therefore suggest that a strong network of adjacent habitats allows for higher levels of biodiversity, an insight that has particular importance for species and habitat conservation. Smaller populations are more endangered in small national parks or biotopes than are more stable populations in larger areas. The size of a particular protected habitat and the number of neighboring habitats are thus extremely important factors for the conservation of biodiversity.

these rates are reversed, diversity decreases. Over time, biodiversity reaches equilibrium. For the reasons given above, this equilibrium is higher for larger islands and for islands close to other inhabited land masses. The comparatively small populations on islands may also develop separately and independently from the founder population. The best-known example of such island speciation is finch populations observed by Charles Darwin on the Galapagos Islands.

These principles of island biogeography also played a role in the radiation of early reptiles in the Upper Carboniferous: forest habitats were isolated as 'islands' when forest cover diminished during this period. At the same time, amphibians began to play a less prominent role in the increasingly dry ecosystems, whereas reptiles, better adapted to drier climates, diversified as a response to environmental change.

extinction rate: number of species that become extinct in a given time period (year, decade...)

founder population: usually just a few individuals of a species which become established in a new area and form the basis of a new, larger population

habitat: area inhabited by a particular species

radiation: rapid diversification of a taxon giving rise to an array of new forms

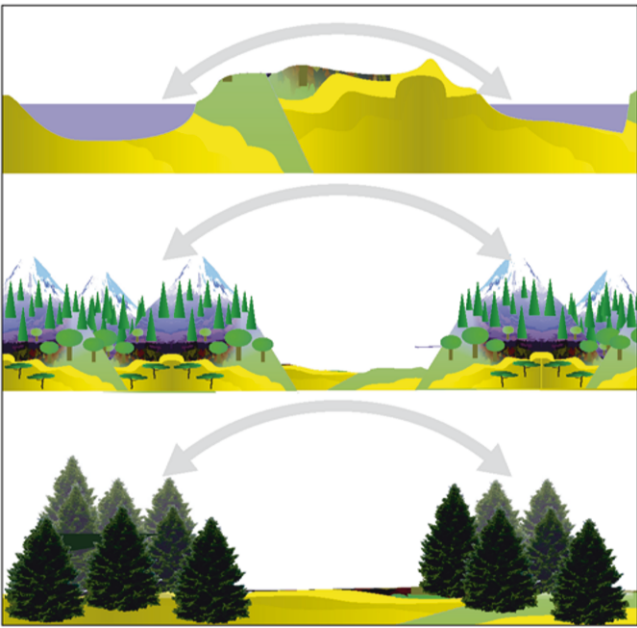
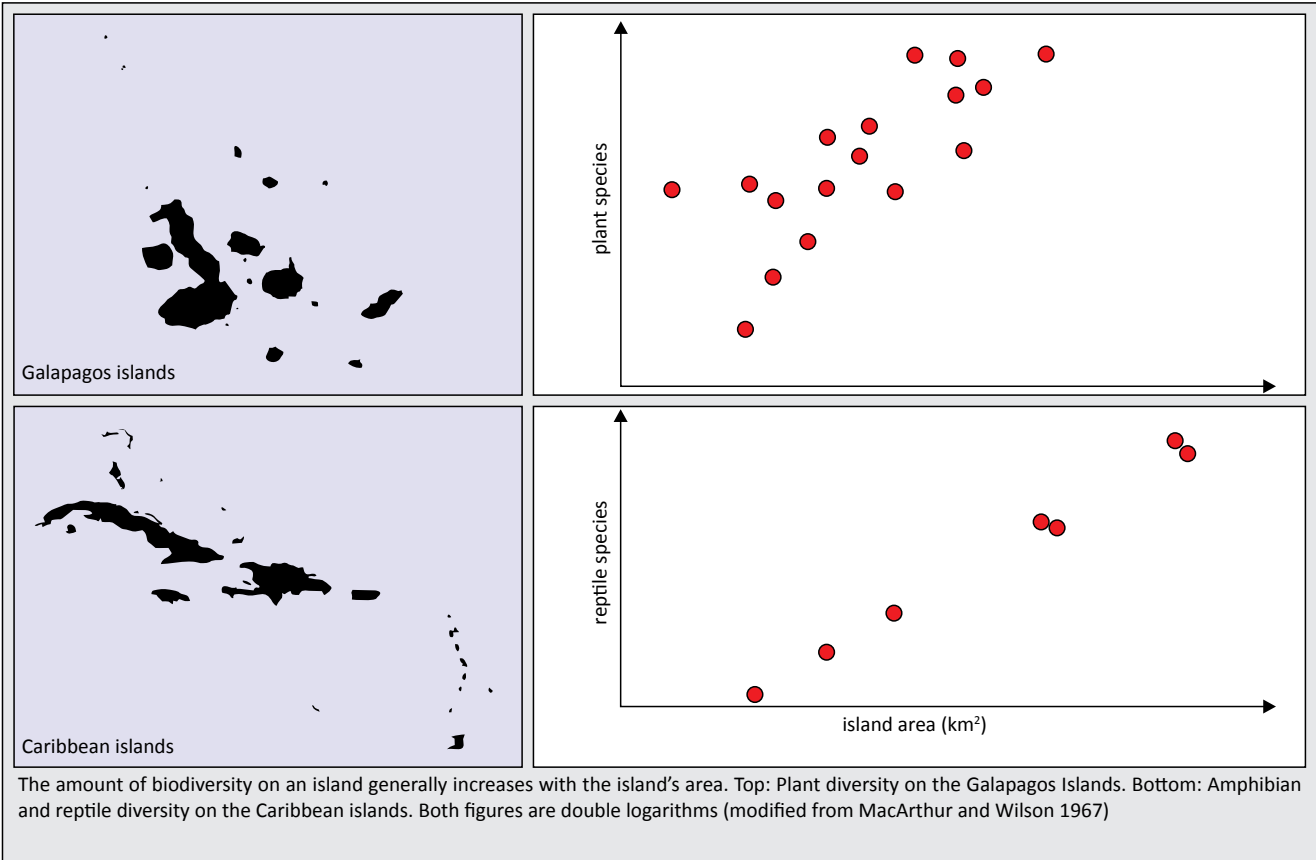

Island biogeography relates not only to islands but also to all kinds of isolated habitat types, including lakes, mountain ranges, and isolated patches of forest. Higher levels of species richness on an 'island' lead to increasing extinction rates and decreasing immigration rates (top-right). As the size of the 'island' increases and the distance to similar habitats decreases, the point of equilibrium between immigration and extinction shifts towards a higher species richness (bottom-right)

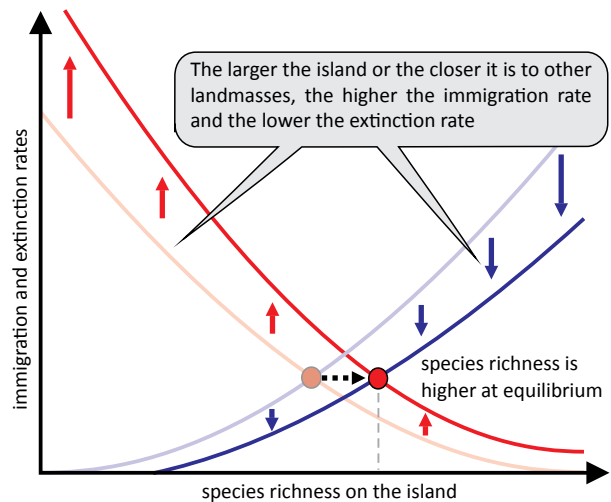
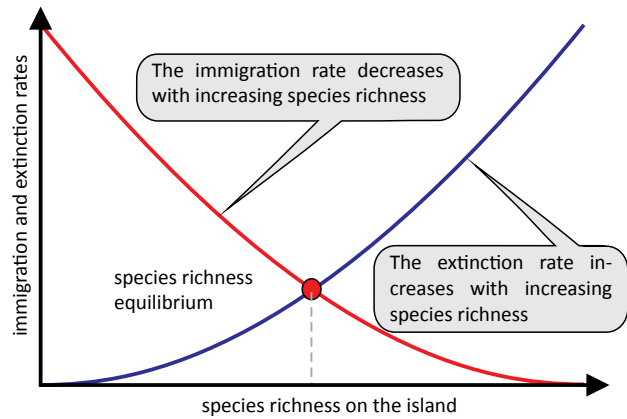



Global biodiversity gradients

■ One of the most striking patterns of global biodiversity distribution is the decrease in the number of species with increasing latitude. In the low latitudes (tropics) the number of species is very high, whereas the opposite is true for the higher latitudes (temperate and polar zones). This does not seem surprising at first from an anthropogenic point of view; however, a number of species are adapted to cold climates and would not be able to survive in the warmer temperatures of the subtropics and tropics, which seem so comfortable to humans. It is in fact not easy to explain the increase in species diversity in warmer climate zones, and many hypotheses which attempt to explain this distribution pattern have been postulated. These explanations are difficult to test because of the lack of independent systems of comparison – we do not know of any other Earth-like planets capable of maintaining life.

Existing hypotheses for the latitudinal distribution of biodiversity can be divided into two groups. In some theories the assumption is made that the number of species in the temperate and polar regions can ultimately be the same as

■ Imbalance theories are based on the assumption of a slow colonisation (or re-colonisation) of climate zones; in other words, the adaptation and dissemination of organisms in more recent geological periods have impacted their current distribution. To that end, the colonisation of cooler climate areas remains ongoing, as most taxa originated and diversified under warmer conditions. Geologically, we now live in a relatively cold period after a long, considerably warmer period of time. Higher species richness in the tropics, therefore, may simply represent a ‘head start’ in the adaptation of species to these climatic conditions. Ice ages have also contributed to current conditions, as they were responsible for higher extinction rates of species living in temperate and polar regions. The low number of species in cooler climates could therefore also be explained as an incomplete post-glacial recolonisation of this habitat.

Equilibrium theories can be explained by distinct hypotheses, three of which are outlined here: Firstly, tropical and subtropical habitats occupy a greater area due to the spherical shape of the planet. These habitats potentially offer more space for organisms and more room for the differentiation of taxa. However, the higher biodiversity levels in the tropics cannot be entirely explained by area alone: Temperate habi-

in the tropics, but so far a balance in species richness has yet to be reached. These theories can thus be termed ‘imbalance theories’, and they rely heavily on climate history and particularly on the effects of glaciation in the Quaternary as well as the effect of warmer climates over long periods of time on the evolution and diversification of extant organisms.

Another set of theories explains latitudinal biodiversity by assuming that the temperate and polar climates have already reached a balance of species richness, but that the upper limits for the number of species they can hold is lower than in the tropics for a number of reasons. These explanations are known as ‘equilibrium theories’ and are based on the larger land and water bodies found in the tropics than in temperate and polar regions, as well as on the higher levels of available energy (higher levels of solar radiation and the associated higher level of primary production) in the tropics. Also important in equilibrium theories is the importance of various climatic conditions on the stability of habitats and their food webs.

tats in the northern hemisphere also occupy large areas of land, but this fact is not reflected in high species richness. A second explanation based on equilibrium theory suggests that survival is simply ‘easier’ in the tropics, as it requires fewer special adaptations. Life in colder climates requires more specialised adaptations for survival during long periods of frost. In the tropics, the necessity for certain combinations of traits is far less restrictive and the probability of survival for newly evolved species with new combinations of traits should be higher. Therefore, more species adapted to warm climates should evolve over time than species adapted to colder climates. A third equilibrium-based theory is based on solar energy, postulating that the tropics receive a higher amount of solar radiation, and thus more energy is at the disposal of primary producers. The resulting higher primary production allows for a stronger niche differentiation (for certain foods) at the highest trophic levels, thereby allowing for more coexisting species. However, the higher specialization of herbivores causes a correspondingly higher rate of specialization in plants. In contrast, fewer species are able to coexist in cooler locations where there is lower primary production and higher seasonality.

latitudinal: distance north or south of the equator measured along a meridian

■ **See also:** Ice age: 2.3.5.6; Climate: 3.2.2.1, 3.2.2.2; Plate tectonics: 2.1.1.2



Equilibrium theories, which explain the distribution of species, often relate to species-area relationships and solar radiation:

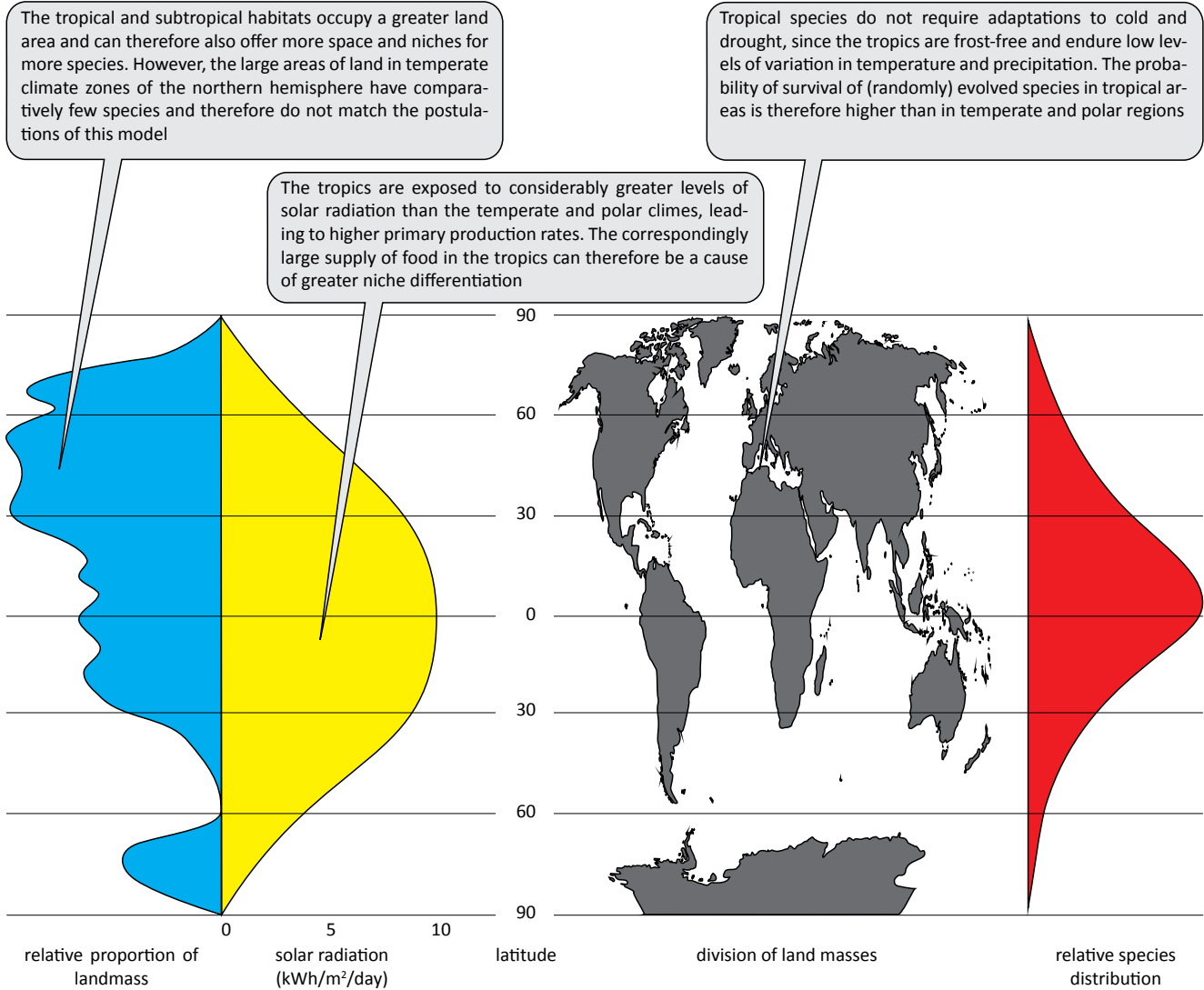

Disequilibrium theories, which explain the distribution of species, often relate to climatic conditions in the younger and older geologic history:

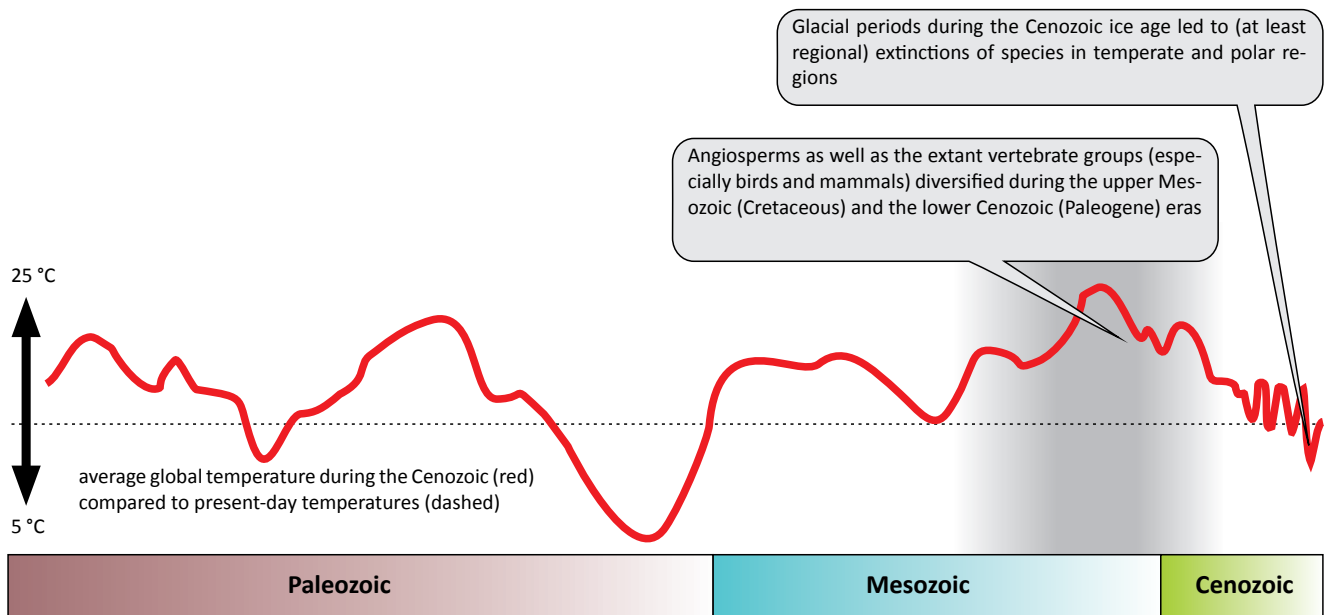



Biogeography of microorganisms

The distribution of prokaryotic and eukaryotic microorganisms is poorly studied. It remains unclear whether dissemination and biogeographic theories established for higher-level organisms also apply to microbes. Various hypotheses have been postulated. On the one hand, the ‘everything is everywhere, but the environment selects’ hypothesis, established over a century ago, postulates that microbial species have a worldwide distribution but that the habitat characteristics affect the occurrence of taxa. In contrast, other theories, in line with observations of higher-level eukaryotes, propose that microorganisms have endemic distribution patterns.

Globally, the number of known species of higher animals and plants increases with decreasing body size. However, there are only relatively few types of described microorganisms. This trend suggests that microbes may be fundamentally more widespread than larger organisms but may also just reflect the poor knowledge on microorganisms.

The taxonomic basis for biogeographic analysis of microorganisms is controversial. Originally, studies of microbial

Historically, the discussion of microbial distribution is based on a combination of morphologically similar species found in geographically distant areas and on misconceptions about the evolution and distribution of these organisms. Before experiments by Louis Pasteur (1822–1895) disproved theories of spontaneous generation of life from mud and contaminated water, it was assumed that lower forms of life could emerge anywhere and at any time wherever suitable living conditions prevailed. This spontaneous emergence of life was known as abiogenesis. It was a logical consequence of this view to expect microorganisms everywhere in suit-

able habitats, and dissemination theories were not necessary, since *de novo* organisms could occur anywhere. The refuting of abiogenesis by Pasteur required an alternative explanation for the assumed distribution patterns of microorganisms, i.e. a worldwide distribution across large geographical distances and barriers. The high density of microbial populations, coupled with their microscopic dimensions, serves as an argument for easy dispersal of species; it is probable that microorganisms are easily distributed far and wide by such vectors as water, wind or via other life forms.

distribution were based on microscopic (and hence morphological) observations. In this original work, morphologically similar species were often grouped together; as a result, proliferation analyses often refer to morphological species complexes and not the distribution of individual species. With this in mind, it is probable that many of the individual species within such species complexes may have geographically restricted distribution areas. Furthermore, for several groups of microorganisms morphological traits are generally of limited value for species delimitations. Molecular analyses have supplemented or even replaced conventional morphological studies of microbial distribution, as they often allow for a higher phylogenetic resolution. However, increasing the level of phylogenetic resolution does not adequately answer the question for the level of phylogenetic resolution required for separating species and for the species concept to be applied.

The debate about microbial distribution patterns is still based on too small a number of dissemination studies. Reliable molecular and morphological data exist only for a limited number of taxa.

endemic: occurrence of organisms within a defined restricted geographical area
morphology: form or shape of organisms; related to external appearance/shape

phylogenetics: the study of the evolutionary relationships between organisms and the evolution of species during the history of the Earth

taxonomy: (Grk.: *taxis* = order, *nomos* = law, ordinance) (usually hierarchical) classification of organisms

ubiquitous: broadly distributed, to be found everywhere



The flagellates of the genus *Paraphysomonas* (Chrysophyceae) have been used as evidence for the worldwide distribution of protists (top-left: *Paraphysomonas* sp.; top-right: distribution of this species). These flagellates possess silicate scales that can be used to differentiate species. The fact that these scales are found globally wherever similar physical and chemical environmental conditions are found has been used as evidence for the global spread of protists, and of microorganisms in general. However, recent studies question whether or not the subjects of these studies are really different species or, rather larger groups of morphologically similar (or cryptic) species. For example, the organisms formerly assigned to the type species *Paraphysomonas vestita* have now been assigned to many different species. They differ from each other in terms of the structure of their scales (three selected examples are shown to the left, enlarged to the same scale) and in their molecular characteristics. The geographical spread of these now more narrowly defined species is, however, unclear, and can currently not be used as evidence for or against a worldwide distribution. Similarly, the suitability of molecular markers ('barcodes') for the analysis of distribution patterns in microorganisms remains controversial; again, it is unclear to what extent the markers actually necessitate the reclassification of various known species

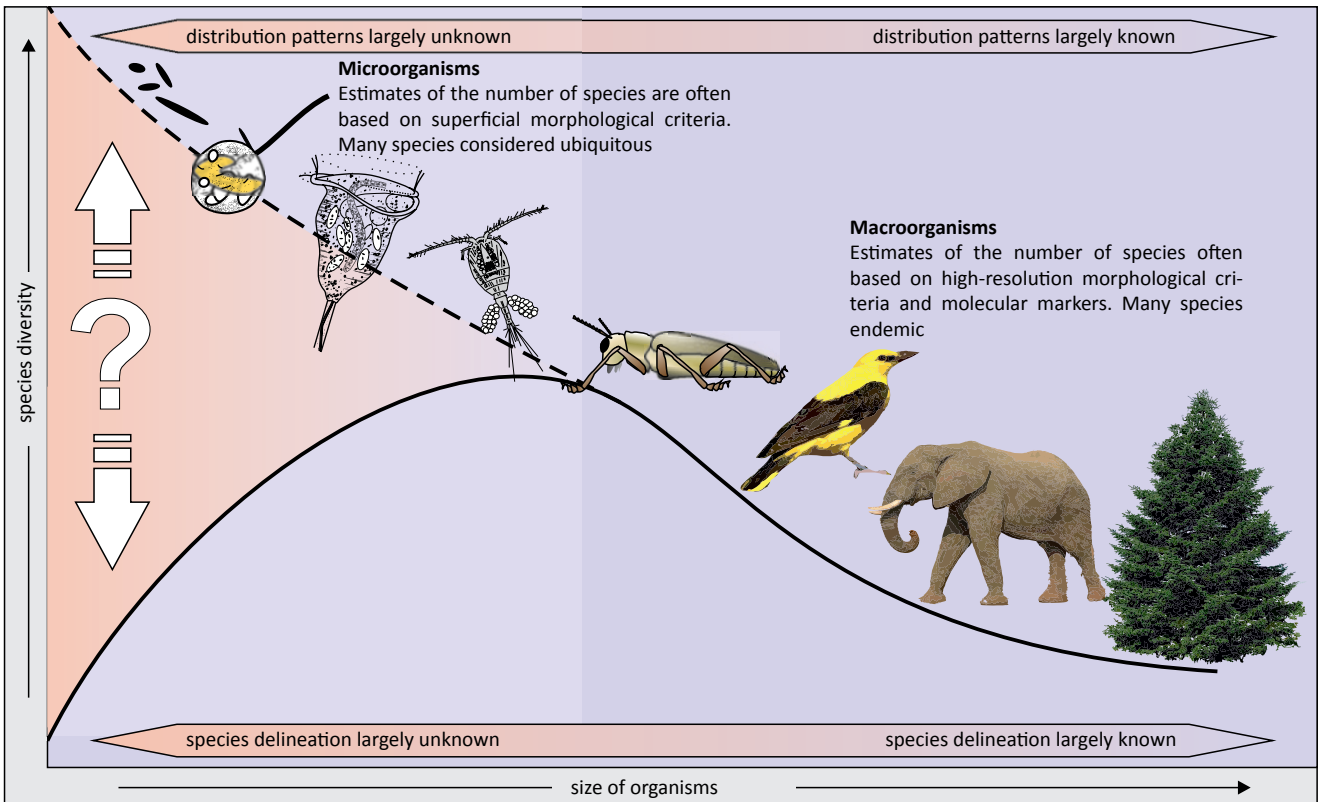

The assessment of total biodiversity at the global level makes an important contribution to the debate about protist distribution patterns. The number of known species of macroorganisms increases as body size decreases. Morphological analyses demonstrate a reversal of this trend for organisms of less than a millimeter in size. Possible reasons for this trend include the wider geographical distribution of these species due to their high population densities and high rates of dispersal. According to this view, few species occupy physically and chemically similar niches across the planet. However, estimates of diversity as a function of body size go hand in hand with increasing uncertainty surrounding species delimitation for smaller organisms



Alien and invasive species

■ Alien species are taxa that have established themselves in an area where they did not exist before. As this has been the case for many species throughout Earth's history, this definition is commonly applied only to species that have migrated in the recent past. Although not universally accepted, an important year of reference for the delimitation of modern-day alien species is 1492, the year in which Christopher Columbus reached the New World and the exchange of species between the Americas and Europe intensified. Humans are among the most important means (vectors) of transport for alien species. This is particularly true for travel by ship, as the ballast water of boats plays a major role in facilitating the spread of aquatic organisms.

■ The propensity for existing biodiversity to be threatened by alien species is complex. In terms of individual habitats, areas of high biodiversity seem less prone to the establishment of invasive species. In such habitats, competition for resources is generally high and the immigration of new species may therefore be difficult to establish. On the other hand, the opposite has been shown to be true for larger ecosystems: the number of invasive species appears to increase with the number of species present. Larger ecosystems may be more prone to species invasions because of an increased availability of resources or because of a high internal heterogeneity of the ecosystem itself. Both factors favour the establishment of al-

In order to survive, alien species must be competitive in their new habitat. They are therefore often characterised by high reproductive rates, rapid growth, and high levels of adaptability. Alien species are thus often r-strategists and generalists. Alien species are also often associated with humans, colonising anthropogenically altered landscapes quickly. They often fundamentally change the composition of the local biocenosis, for example through predation or as a result of competition pressure. Along with habitat fragmentation, invasive species represent one of the most important factors contributing to the extinction rate of current species.

ien species. Disturbed ecosystems are also susceptible to the establishment of new species, since disturbance events tend to lower competitive pressures in an area. This phenomenon explains why alien species so easily invade anthropogenically influenced habitats.

Some of the most important alien species cannot be regarded as invasive, despite their continuous dissemination and detrimental economic impact. For example, grape phylloxera, a pest of commercial grapevines worldwide, spread slowly and its negative impact is only observed in plant (grape) species monocultures and almost not at all on the wider biodiversity of newly invaded habitats.

anthropogenic: (Grk.: *anthropos* = man, *gen* = cause) caused, influenced, brought about by human beings

generalists: organisms able to survive under a variety of conditions

habitat: area inhabited by a particular species

habitat fragmentation: process by which habitat loss results in the division of large habitats into a greater number of smaller patches

r-strategists: species which focus on producing a high quantity (r) of offspring

sailing ballast: water used by ships (voyaging without cargo) to keep the vessel upright

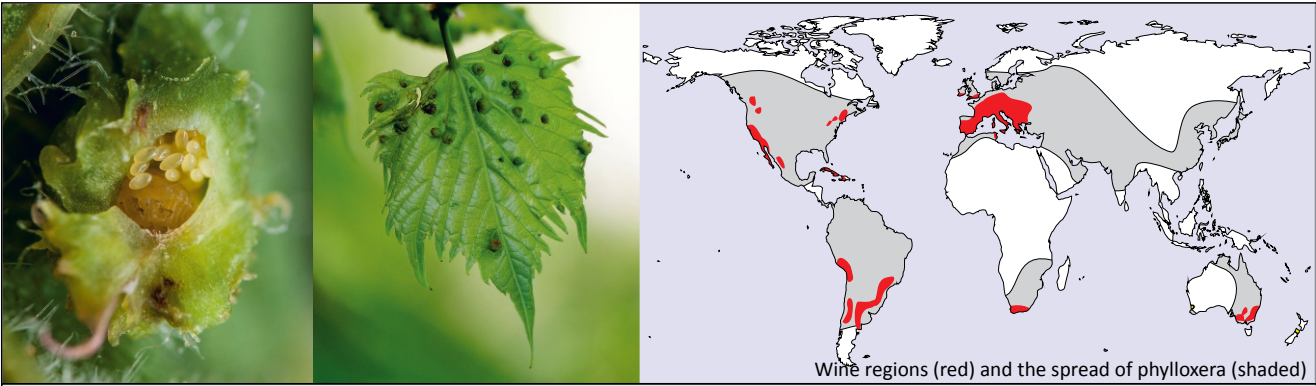

Wine regions (red) and the spread of phylloxera (shaded)

Phylloxera (*Viteus vitifoliae*) is a serious viticultural pest. In a complex generational alteration, it infests the roots and leaves of grapes (*Vitis vinifera*). It originated in the 1860s in the northeastern United States and spread to European wine regions before dispersing worldwide to grape-growing areas. Since it spreads slowly and only affects monocultures within the plant cultivation area, phylloxera is not referred to as an invasive species

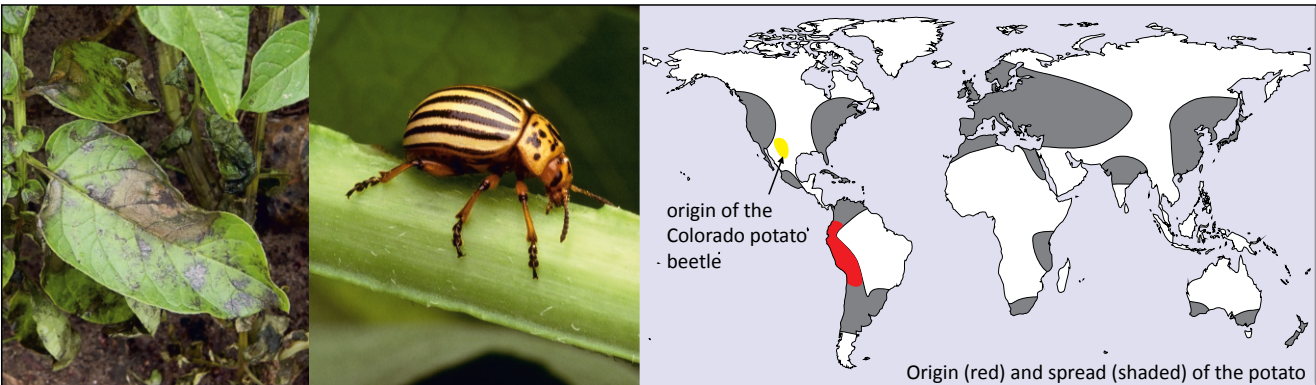

origin of the Colorado potato beetle

Origin (red) and spread (shaded) of the potato

Blight spread worldwide within the cultivation of potatoes (left: potato leaves infected by *Phytophthora infestans*). The Colorado beetle (middle: *Leptinotarsa decemlineata*, the Colorado potato beetle) originates in the southwestern United States whereas *Phytophthora infestans* has an unclear background, though its first documented outbreak was in 1843 in the eastern US. The transmission of infected potatoes to Europe triggered the great Irish famine of 1845–1953



Zebra mussel (*Dreissena polymorpha*)

The zebra mussel (*Dreissena polymorpha*) originates near the Black Sea and spread across Europe in the 19th and 20th centuries. In 1986, it was first detected in North America (Lake St Clair) and reached the Great Lakes in 1990 and central to western US by 1995

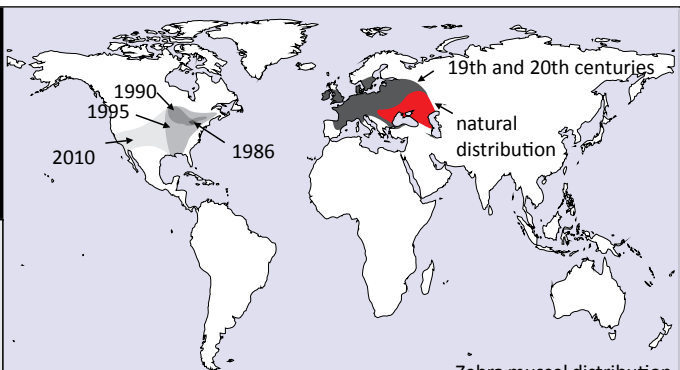

Zebra mussel distribution

The spread of zebra mussels fundamentally altered limnic ecosystems and the organisms they housed. A notorious example of the wider impact of zebra mussel introduction is on bitterlings, which lay their eggs using an ovipositor into the gill chamber of large freshwater mussels, such as the painter's mussel. The young fish subsequently develops there before leaving the shell a few weeks later. However, zebra mussels colonise the shells of these mussels, so bitterling eggs no longer can reach the gill cavity, putting their reproductive success at risk

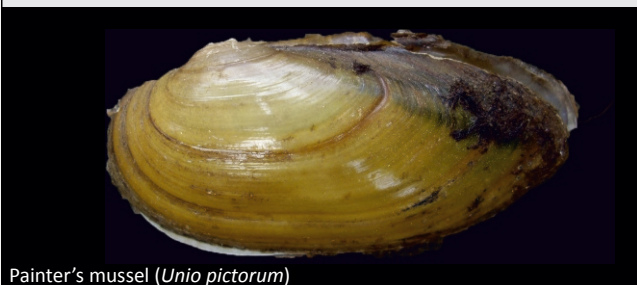

Painter's mussel (*Unio pictorum*)



European bitterling (*Rhodeus amarus*)



Cenozoic mass extinction

Many species have gone extinct in Earth's history, not only during the prehistoric mass extinctions but also during relatively recent history, including during the upper Cenozoic Era. These relatively recent extinctions are partly a result of changes in climatic conditions but are mainly due to human activities. Climatic fluctuations during the Quaternary (the most recent of the three periods of the Cenozoic), especially fluctuations between glacial and interglacial periods, closely coincide with the extinction of many organisms. Extinction rates of many larger mammals (megafauna) reached their peak near the end of the last glaciation, roughly 11,000 years ago. This particular extinction included many large mammals of the colder periods, including the mammoth (*Mammuthus primigenius*) and the woolly rhinoceros (*Coelodonta antiquitatis*), as well as those adapted to warmer periods, such as the forest elephant (*Elephas antiquus*) and the forest rhinoceros (*Dicerorhinus kirchbergensis*). Many predators also disappeared at the same time, including the saber-toothed cats (*Homotherium* spp., *Smilodon* spp.). The time of these extinctions roughly correlates with the appearance and spread of

Extant biodiversity is only a small fraction of the planet's total diversity over time. Over 99% of the 4 billion species estimated to have lived throughout Earth's history are extinct. Extinctions are normal when considered in geological time scales; mass extinctions, however, were relatively rare. Only a small number of total extinctions have thus occurred during mass extinction events. In the paleontological sense, mass extinctions are periods in time when extinctions outweigh speciation so that there is a loss of more than 75% of species diversity within a geologically short period of time (less than around 2 million years). In that sense, two of the great mass extinctions, known as the Big Five, are not strictly mass extinctions (the Devonian and Triassic) but rather only massive biodiversity depletions. During these two events, the extinction rate remained relatively normal but speciation rates were considerably lower than usual.

Major geological mass extinction events usually appeared alongside major climatic, atmospheric, and ecological upheavals. The combination of different stress factors was likely related to the strength of the impact of each event. Accordingly, in the current Cenozoic Ice Age (Quaternary), ecosystems have been exposed to increased climatic stress

modern humans across the planet, although the extent of the effect of early humans on extinction rates remains unknown. Climatic fluctuations and associated habitat shifts are also thought to have affected megafaunal extinction patterns.

The effect of human activity on extinction patterns is clearer in the more recent past. Some species were even deliberately eliminated, such as the thylacine (also known as the Tasmanian tiger). Other species went extinct when alien species were introduced, the best known example being the dodo (*Raphus cucullatus*). This large, flightless bird, endemic to the island of Mauritius, was wiped out when its nest sites were destroyed by rats and feral livestock introduced by humans. Many species are currently threatened with extinction, and it is likely that many of these will in fact go extinct in the coming decades. The extinction of some of these species, for example the Sumatran rhinoceros, can be delayed by national and international protective measures, although to what extent these measures will be able to sustainably protect endangered wildlife remains unclear.

due to the alternation of glacial and interglacial periods. Due to current factors including increases in atmospheric carbon dioxide concentrations, habitat fragmentation, increases in the dispersal of alien species and ever-increasing concentrations of pollutants, stress levels on existing species are currently much higher than they have been in the past. These factors and many others are likely to pave the way towards the next period of mass extinctions.

Species known to be endangered or extinct are increasingly well documented. Although the number of such species is increasing rapidly, it is still almost certainly a considerable underestimation of the actual number, as many species have not yet been formally described. It is clear, however, that current extinction rates are already higher than during some of the other major geological periods of heavy extinction. On the other hand, the total number of species which have gone extinct during the Quaternary is so far not as high as during the known periods of mass extinction. However, if one includes endangered species, *i.e.* those at risk of extinction, it is likely that within a few hundred years the number of extinct species will have reached the dramatic levels which existed during the mass extinction events.

Cenozoic Era: most recent era in Earth's history (covering the last 66 million years)

glacial: (Lat.: *glacies* = ice) interval of time marked by cold temperatures

habitat fragmentation: process by which habitat loss results in the division of large habitats into a greater number of smaller patches

interglacial: interglacial period; warm period between two glacial periods

megafauna: large or giant species of animals from the Neogene and the early Quaternary

palaeontology: (Grk.: *palaios* = old, *logos* = discourse) the scientific study of life before the Holocene

Quaternary: the most recent period in the Cenozoic Era spanning the last 2.588 million years and including the present

recent: (Lat.: *recens* = fresh, new) having happened not long ago

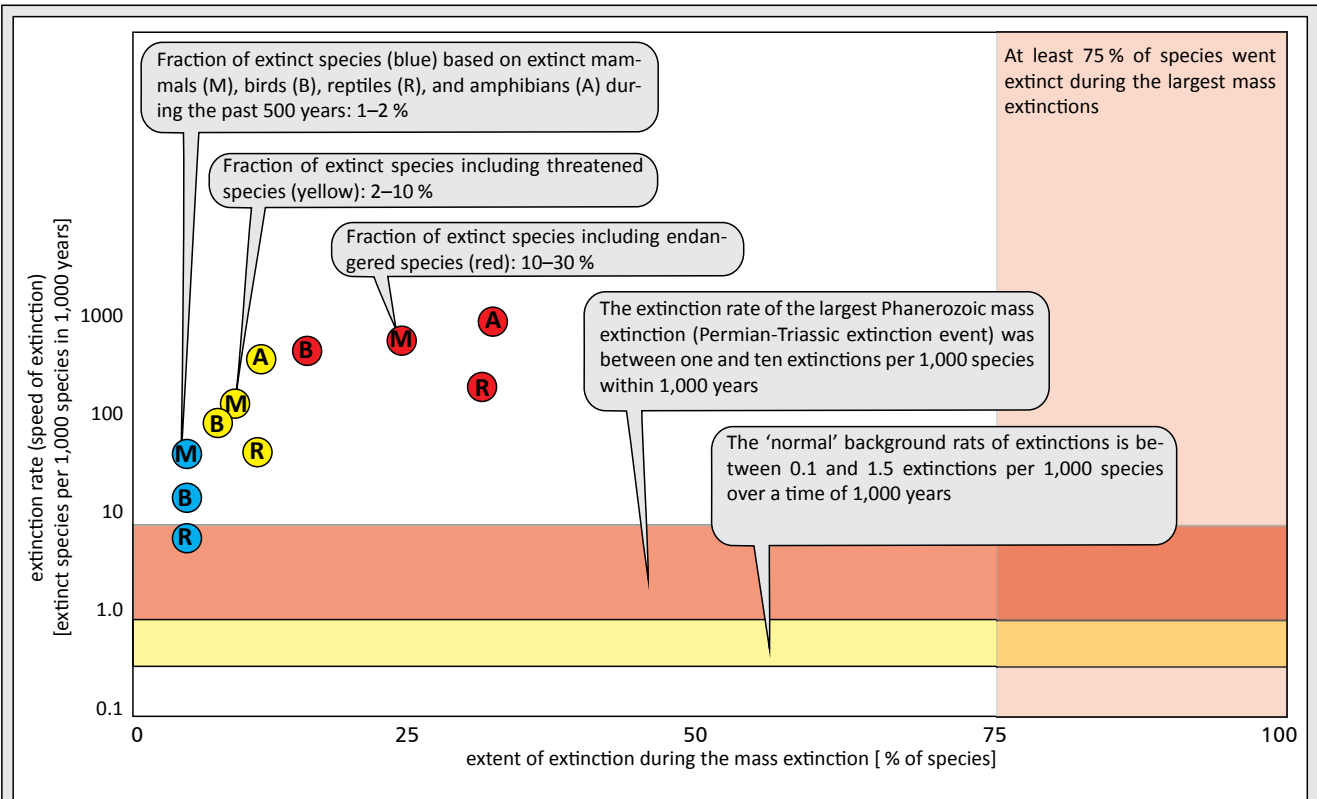

The current rate of species extinction (blue dots) is significantly higher than the average background level during Earth's history (yellowish area). Even the extinction rates during the largest mass extinction of the Phanerozoic (Permian-Triassic, orange area) were well below those witnessed today. Although the proportion of species which have gone extinct within the last 500 years is still quite low (blue dots), if you add the potential extinction of threatened (yellow dots) and endangered (red dots) species in the calculation, nearly 30 % of species are likely to go extinct in the near future



Climate change and habitat loss contribute to the acceleration of the current species extinction rate. For example, the consequences of a changing climate has led to the bleaching of corals (left) and the retreat of glaciers (e.g. Briksdalen glacier, Norway, 2003 (middle) and 2008 (right))



Saber-toothed cats (left: *Smilodon* sp.), along with many other large mammals, went extinct at the end of the last glacial period. The thylacine (middle: *Thylacinus cynocephalus*) was once widespread in Tasmania, but was heavily hunted and eventually eradicated by 1930 after the introduction of sheep farming. The last individual thylacine died in a Tasmanian zoo on 7 September 1936. The Sumatran rhino (*Dicerorhinus sumatrensis*, right) is classified as critically endangered, with just under 300 heavily protected individuals thought to inhabit different national parks across Sumatra and Malaysia



Biogeographic regions

■ Biogeography is the study of the current distribution of organisms and the historical development of this distribution. Likewise, phytogeography and zoogeography are terms referring to the biogeography of plants and animals respectively.

Biomes are regions where similar life forms occur; the plants and animals which occur there have similar adaptations to the environmental (climatic) conditions of that habitat. Floral and faunal kingdoms are, on the other hand, those with systematically or taxonomically similar communities of species. These characteristics reflect the relative position of land masses to each other over the course of Earth's history.

Life forms in different biogeographic provinces are often made up of different plant and animal families, despite potentially similar ecological functions. For instance, cacti

■ The borders of phytogeographic and zoogeographic provinces often run alongside each other, but they are not exactly the same. This is particularly obvious in southern Africa, which has its own phytogeographic kingdom – the Cape Floristic Region – which is phytogeographically but not zoogeographically separate from the Palearctic Kingdom (Paleotropis), which includes the rest of Africa. On the other hand, subdividing the Holarctic into the Palearctic and the Nearctic as well as the Paleotropis into the Afrotropic and the Indo-Malayan (Orientalis) is more common in zoogeography than phytogeography.

The Cape Floral Region is the smallest of the six floral kingdoms on the continents, and includes the winter rain area on the southwestern tip of Africa. The dispersal of plants to and from other floral kingdoms is greatly hampered by adjacent deserts and semi-deserts (the Namib, Koo, Kalahari). Consequently, many of the species found within the Cape Floral Region are endemic; this region is also the most species-rich floral kingdom in relation to surface area. For the (mobile) fauna, the geographical barrier into the Cape Floral Region is considerably easier to overcome; the zoo-

from the deserts of Central America occupy a similar niche as euphorbias (the spurge family) from the Namib desert in southern Africa.

Floral and faunal composition changes strongly near the boundaries between different biogeographic areas due to the long periods of geological time during which lineages evolved independently, i.e. in spatial isolation from each other. Floral and faunal borders are mostly natural distribution barriers, like oceans, mountains or deserts; the degree of difference in flora and fauna across a particular border depends on how long the barrier has existed. Biogeographic separation at such borders therefore includes differences in higher-level taxa (families and genera) as well. The characteristic flora and fauna for each biogeographic province is known as its floral or faunal element.

biogeographic isolation of southern Africa is therefore far less pronounced.

Noticeable differences between zoogeography and phytogeography are also found on the border of the Indo-Malayan (Orientalis) and Australasian regions. The zoogeographical border at that location is marked by the Wallace line (between Bali and Lombok in the south and between Borneo and Sulawesi in the north). The area between the Wallace line and the Australian shelf edge is also referred to as Wallacea and is partially separated from the large faunal kingdoms. Present-day species distribution patterns here correlate with the presence of land bridges during the last ice age: Sumatra, Java, Bali, and Borneo were connected to the Asian mainland via land bridges, and islands on the Sunda shelf were connected to Australia in the same way. In contrast, the islands of Wallacea were not linked to the mainland through land bridges during the last ice age, and therefore deviate zoogeographically from the Indo-malayan or Australasian regions. The phytogeographical boundary in the region runs along the Australian mainland. Only a few islands harbour Australasian flora, whereas the Pacific island arc falls within the Palearctic Kingdom.

endemic: occurrence of organisms within a defined restricted geographical area

■ **See also:** Plate tectonics: 2.1.1.2, 2.3.1.1



The Palearctic and Nearctic were connected to each other for a long period of time. These regions were united within the continent of Laurasia after the breakup of Pangaea, and were separated around 150 mya by the development of the Atlantic. North America and Asia were also connected via the Bering Strait as a result of the low sea levels during Cenozoic glacial periods. Their history of connectedness is reflected in their similar flora and fauna. The Nearctic and Palearctic are therefore known together as the Holarctic. In contrast, the present-day connection between North and South America via the Isthmus of Panama is relatively new; these areas were joined only 3 million years ago after a long time of separation

Terrestrial habitats are divided into eight biogeographic regions (also known as ecoregions or ecozones) closely corresponding to the areas of distribution of many animal and plant families. Their distribution patterns can be explained by the historical positions of the continents. Land masses which were previously connected by land bridges exhibit many common plant and animal families today. The significance of each region and its borders are differently interpreted in phytogeography and zoogeography: although the World Wide Fund for Nature (WWF) attempts to combine the two systems, a slightly stronger use of zoogeographic than phytogeographic information can be noticed in the divisions

The Nearctic comprises North America, including the highlands of Mexico, northern Florida and Greenland

The Palearctic includes Europe, northern Africa and northern Asia to the northern edge of the Himalayas

Oceania comprises many small islands in the Pacific. The boundaries of the biogeographic region deviate from the cultural-economic demarcation of Oceania in that the latter also includes Australia and New Zealand

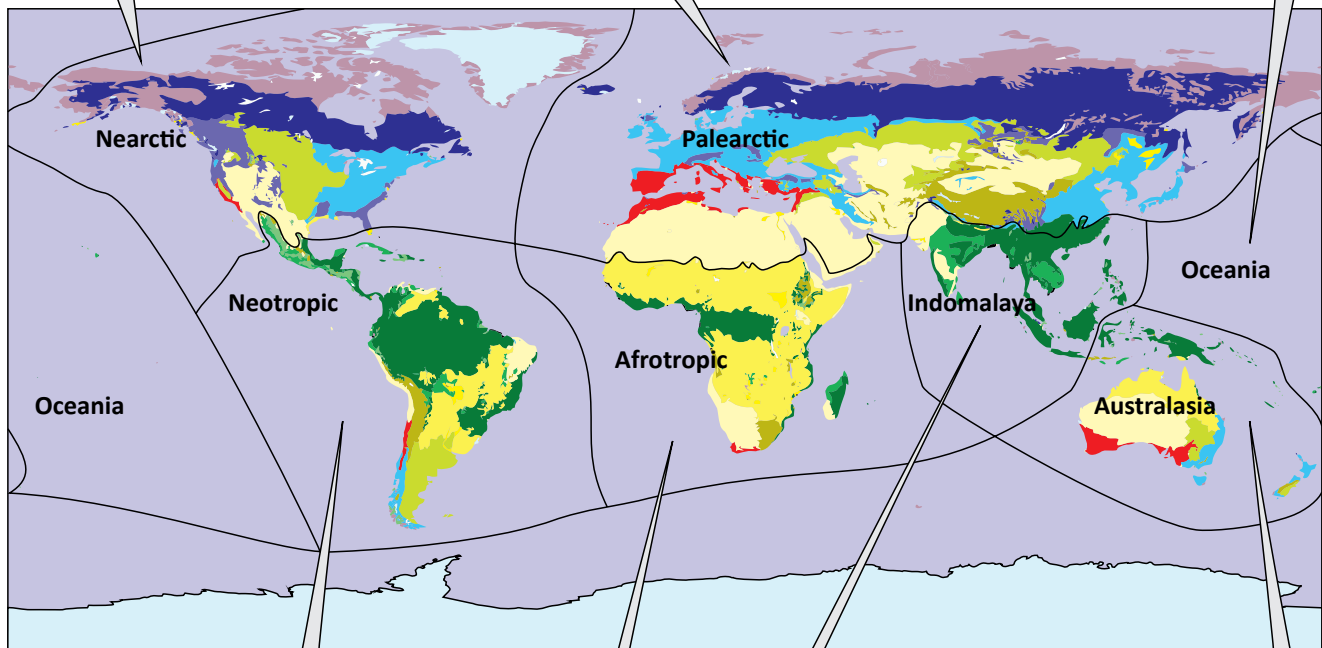

The Neotropic includes South and Central America, Mexico, and the south of Florida. From a botanical perspective, the southern tip of South America is excluded from this region and instead part of the Antarctic floral kingdom

Australasia includes the areas that were connected to Australia via a land bridge during the last ice age (Australia, New Guinea and Tasmania) as well as New Zealand and parts of Indonesia

The Afrotropic includes Africa south of the Sahara. From a phytogeographic perspective, most of Sahara and the Arabian Peninsula belong to this region, whereas the southern tip, known as the Cape Floristic Region, is excluded

The Indomalaya or Oriental Region covers Asia south of the Himalayas and some areas to the east

The Indomalaya and Afrotropic are combined (as the Palearctic) as they share many plant and animal species. India was linked to southern Africa for a long time until the Indian plate broke up during the Jurassic and drifted northward during the Cretaceous. The Himalayas served as a dispersal barrier after the collision of the Indian plate with the Eurasian plate in the Tertiary, limiting the exchange of species between the Indomalaya and the Palearctic

The classification presented here divides the planet into 14 major habitat types, following the suggestion presented by the WWF. For example, similar to the Anglo-American biome delineation, temperate and hot deserts are placed together, whereas these are considered to be separate in other systems. The relationship between rainfall and evaporation rates plays a central role in this delineation of biomes. Other systems, such as the one widely used in Germany, take the seasonality of temperature and precipitation into consideration as well

| | | | |
|--|--|--|-----------------------------------|
| | tropical and subtropical moist deciduous forest | | temperate grassland |
| | tropical and subtropical arid deciduous forest | | montane grass- and bushland |
| | tropical and subtropical coniferous forest | | flooded grassland |
| | temperate deciduous and mixed forest | | tundra |
| | temperate coniferous forest | | Mediterranean forest and bushland |
| | boreal forest / taiga | | desert and arid bushland |
| | tropical and subtropical grasslands and bushland | | mangrove |
| | | | rock and ice sheets |



Global precipitation and temperature distribution

Climate zones of the world and thus also the ecoregions are largely defined by the availability of sunlight and the resulting temperature and precipitation conditions. Seasonal changes in precipitation and temperature conditions are usually presented in climate diagrams, including the frequently used Walter and Lieth climograph, in which the amount of precipitation and the temperature have been scaled so that humid conditions (when the precipitation line is above the temperature line) and arid conditions (when the precipitation line is below the temperature line) can both be directly read.

Global temperature and precipitation patterns result in a formation of a basic pattern of climatic zones, and with that of biomes, with increasing distance from the equator. The distribution of land masses and high mountains also affect regional climatic conditions. The Köppen-Geiger classification zones are distinguished as follows: tropical rain climates are characterised by high rainfall and a monthly average temperature of at least 18°C during all months of the year, whereas drier climates are characterised by low rainfall and are divided further into desert and steppe climates.

The location of land masses affects climatic patterns; in general, precipitation decreases with increasing distance from coastal regions, e.g. precipitation is considerably lower in the interior of Asia or North America compared with their coastal areas. Furthermore, the distribution of precipitation is affected by wind patterns: The westerlies of Central Africa (from the Atlantic Ocean to the east) lead to high rainfall in the western and central areas, whereas eastern regions are drier. Mountains also impact climatic patterns by caus-

The time when precipitation occurs also affects this classification, *i.e.* conditions are assessed according to whether rainfall occurs predominantly in winter or in summer. If rainfall is measured in mm and temperatures in degrees Celsius (°C), the winter rainfall areas of deserts receive annual rainfall values below that of their annual mean temperature, whereas precipitation values in winter rainfall areas in steppes are maximally twice as high as their mean temperatures. Precipitation in summer rainfall areas of dry climates are generally somewhat higher.

Warmer-temperate rain climates have a higher total precipitation than dry climates. In general, the coldest month in the temperate climates has a mean temperature of between -3 and 18°C and the warmest month over 10°C.

Boreal climates are characterised by average monthly temperatures of below -3°C in the coldest months and over 10°C in the warmest months.

Snowy climates are characterised by an average temperature in the warmest month of below 10°C (tundra), or of below 0°C (permafrost).

ing air currents and, importantly, by forcing air to rise and cool (forced convection) causing moisture in the air to condense, forming clouds and eventually rain. On the leeward (downwind) side of the mountain, air masses sink again and increase in temperature, decreasing relative humidity and resulting in low levels of precipitation. For example, the west coast of North America receives relatively high levels of rainfall, whereas land east of the Rocky Mountains is far drier.

arid: dry

ecoregion: a relatively large area of the earth's surface 'containing a geographically distinct assemblage of species, natural communities, and environmental conditions' (WWF definition); the term 'ecoregion' was originally used in the context of geographical scholarship (meaning a 'recurring pattern of ecosystems as-

sociated with characteristic combinations of soil and landform that characterize that region')

humid: relatively high level of water vapour in the atmosphere
Intertropical Convergence Zone (ITCZ): low-pressure trough near the equator measuring only a few hundred kilometres across; it appears as a band of thick cloud and is an area of high precipitation

See also: Climate evolution: 2.3.1.1; Global wind systems and climate zones: 3.2.2.2

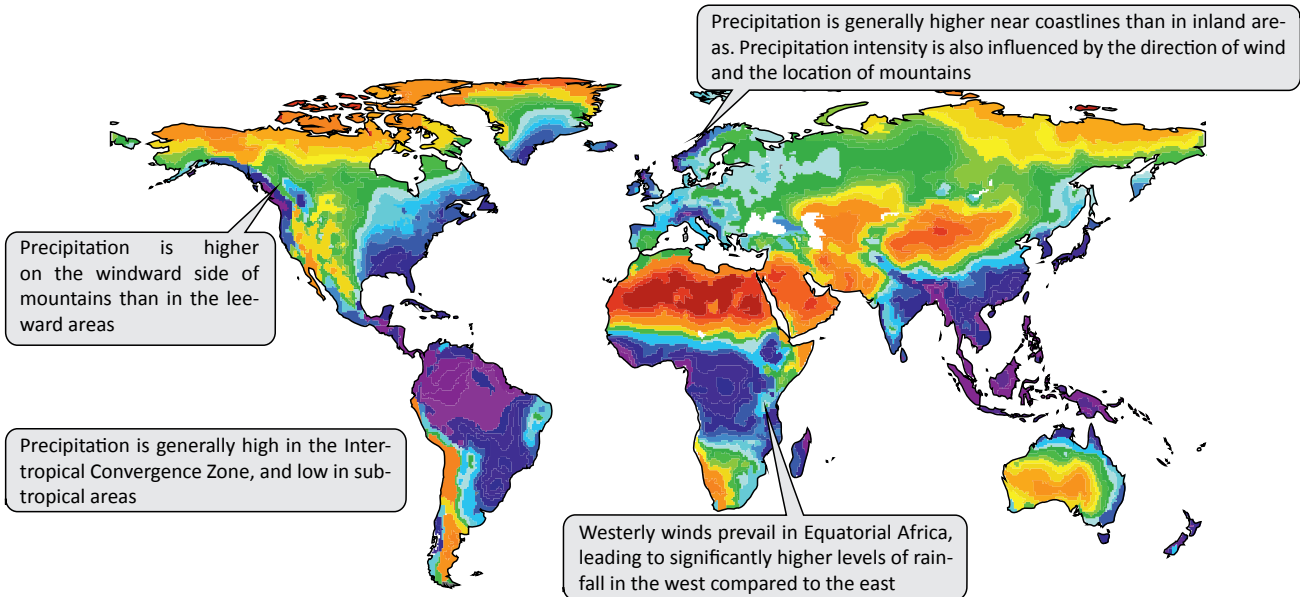
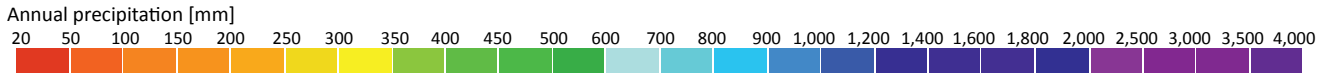

Climate diagrams show temperature and precipitation patterns. Climate diagrams in the style of Walter and Lieth show monthly average temperatures (red line) on the left ordinate (y-axis) alongside rates of monthly average rainfall (blue line) on the right ordinate. A precipitation of over 100 mm is shown five-fold compressed. The graphs are scaled so that 10 °C corresponds to 20 mm of rainfall

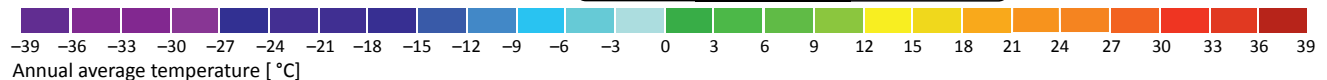
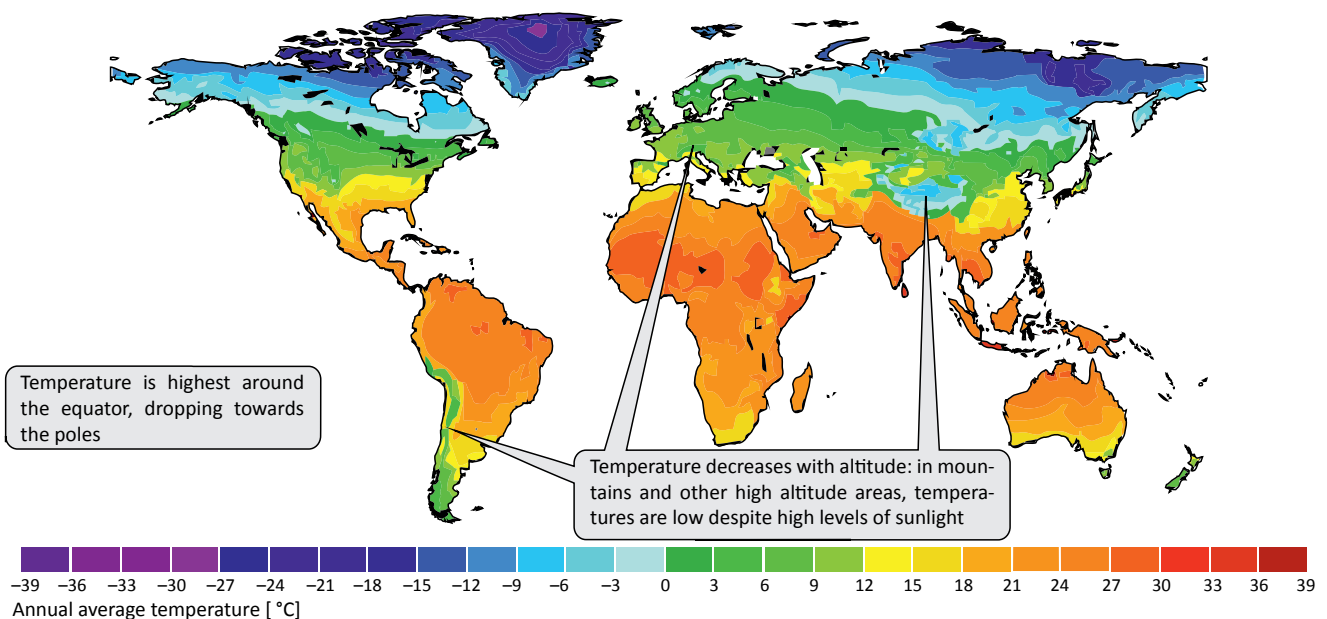
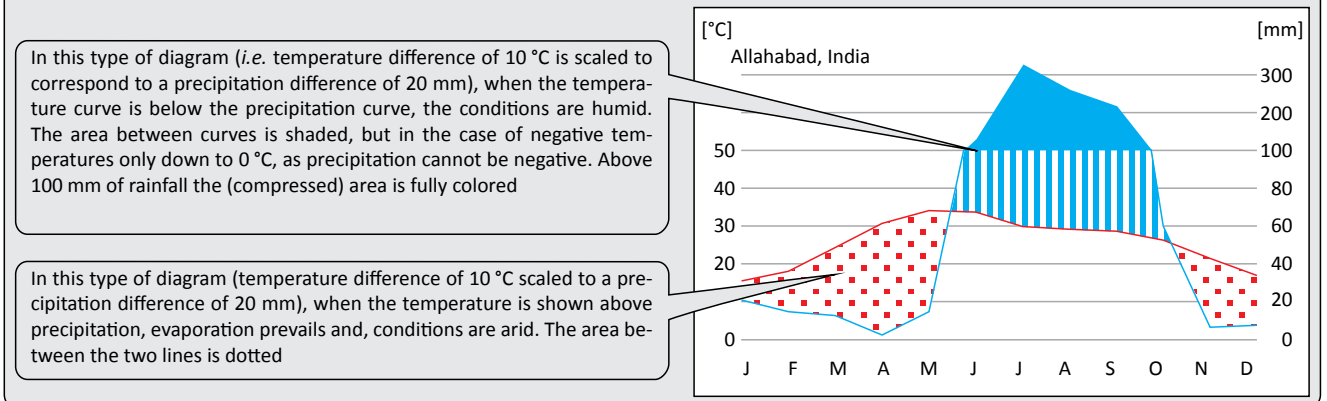



Global wind systems and climate zones

■ Climate zones are regions of similar climatic conditions, which usually span east-west around the earth. Astronomically, the tropics (between the northern and the southern Tropical Circles), the mid-latitudinal zone (between the Tropical and Polar circles) and the polar zone (between each Polar Circle and its pole) are separated based on insolation. As the actual climatic conditions follow only loosely these borders, the effects of climate such as vegetation patterns are increasingly included within the classification system in addition to the actual climatic elements. Therefore the zones used in the climate classification largely correspond to major habitat types or biomes established according to ecological

■ The sun is at its highest point around the equator; consequently, equatorial territories experience the highest levels of solar radiation and temperatures on Earth. Solar radiation levels and average temperature drop with increasing distance from the Equator.

The high levels of sunlight around the Equator cause warm and moist air to rise. Consequently, the rising air cools off and the saturation vapour pressure sinks, causing water vapour to condense and form rain. The tropics are therefore consistently warm and humid. The rising air flows into higher altitudes and disperses toward the poles; an atmospheric circulation known as the Hadley cell.

These air masses sink again in the subtropics. As the air masses warm as they descend, the saturation vapour pressure increases (the air can take up more moisture, meaning that the relative humidity sinks). As a result, the subtropical latitudes are drier. The descending air masses split, either heading back to the Equator or towards the poles.

In temperate zones, the air tends to rise again (Ferrel cell), again causing higher levels of precipitation. At the permanently cold poles, the air current finally sinks again (Polar cell).

Various authors present differing classification schemes for biomes. In the German-speaking world, the Breckle and

criteria. Precipitation and temperature distribution patterns are particularly important for the classification of climates.

The term 'biome' refers to major habitat types including the animals and plants (biotic communities) potentially living in this habitat type, as well as the abiotic factors occurring there. According to the current way of thinking, the term is therefore an ecological one. The definition of a biome is based on the occurrence of distinct (ecological) life forms and on particular adaptations of the organisms, not on taxonomy or systematics. As the distribution of life forms is largely driven by climatic factors, climate (particularly precipitation and temperature distribution) is the major factor behind the definition of biomes.

Walter classification features nine distinct biomes which take established patterns of seasonality in precipitation and temperature distribution into account. It distinguishes between Zonobiomes, Orobiomes and Pedobiomes. Zonobiomes comprise landscapes similar with respect to climate, vegetation, fauna and soil types; they run circularly around Earth in a similar manner to the climatic patterns. Orobiomes form a narrow girdle around the altitudes of mountain ranges, and Pedobiomes cover special sites characterised by distinct soils such as sand, rocks and saline soils.

The English-speaking world often uses the Whittaker classification of biomes in which 25 biome types are characterised mainly according to mean annual precipitation and evaporation. The discrepancy between this system and the German one is mainly based on varying methodologies of grouping ecosystems with similar climatic conditions, and on the difference in emphasis on the seasonality of precipitation and temperature.

Another current biome classification system was designed by the World Wide Fund for Nature (WWF) and features 14 major habitat types (biomes). This system is based on the result of various international case studies and conservation assessments.

evaporation: vaporisation of moisture from unvegetated land or the surface of a body of water

solar climatic zones: classification of climate zones based exclusively on the intensity of solar radiation; the lines of division

between the solar climate zones are the tropics and the polar circles



Atmospheric circulation patterns are driven by the differing intensities of sunlight at the equator and around the poles. Warm air rises at the equator; colder air descends around the poles. This circulation results in three circulation streams: the Hadley, Ferrell, and Polar cells

These climate diagrams display:
 Temperature (red): -30 °C to +30 °C
 Precipitation (blue): 0–300 mm/month
 (Diagrams not according to Walter and Lieth)

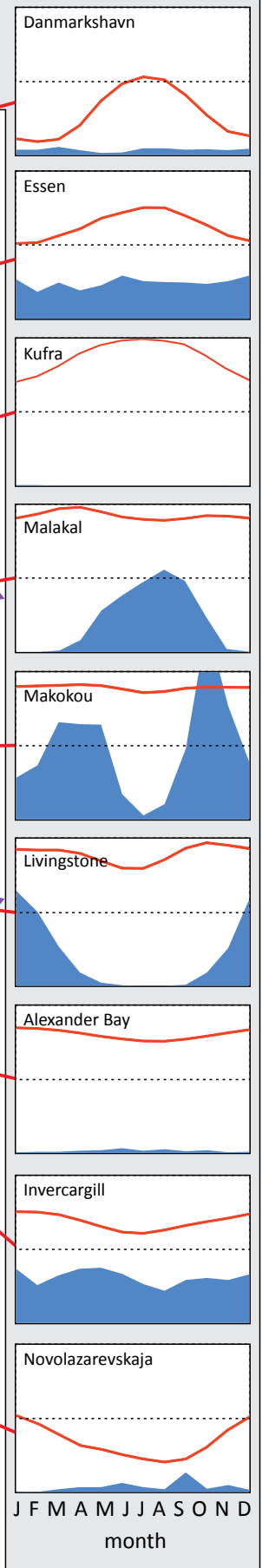
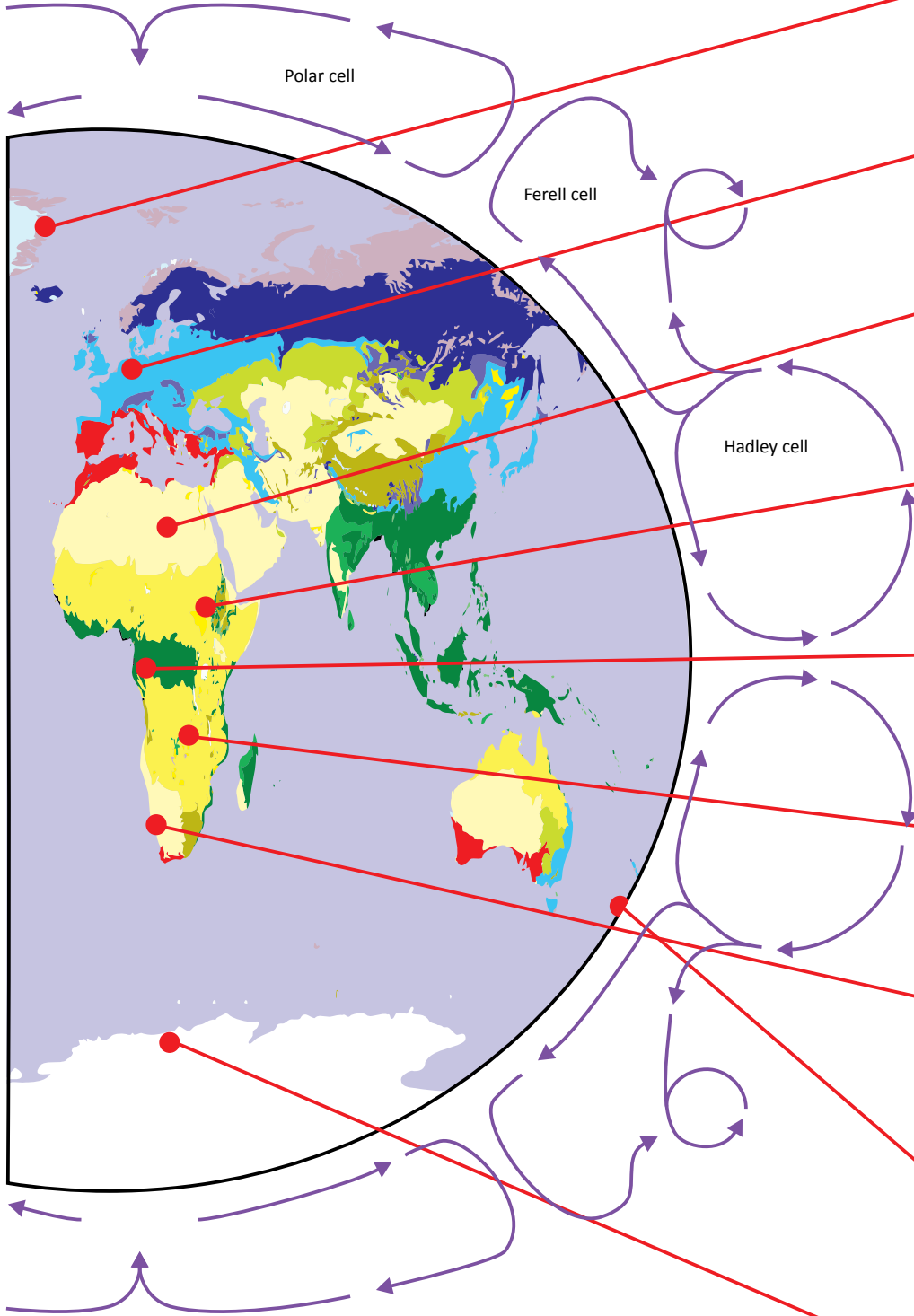

- | | | |
|---|--|--------------------------|
| tropical and subtropical moist deciduous forest | tropical and subtropical grasslands and bushland | desert and arid bushland |
| tropical and subtropical arid deciduous forest | temperate grassland | mangrove |
| tropical and subtropical coniferous forest | montane grass- and bushland | rock and ice sheets |
| temperate deciduous and mixed forest | flooded grassland | |
| temperate coniferous forest | tundra | |
| boreal forest / taiga | Mediterranean forest and bushland | |

J F M A M J J A S O N D
month



Tundra

■ The tundra biome begins just north of the 10°C July isotherm and extends to the polar deserts. Tundras are mainly found in the northern hemisphere, comprising about 7.6% of the earth's total land area.

The climate within the tundra is polar, with very short summers and low temperatures throughout the year (under 10°C on average for each month of the year); even in the summer the average temperature is around 0°C. During the coldest months, the average temperature may drop to between -15°C and -40°C. Only in areas strongly influenced by the ocean may winter temperatures hover around freezing.

Precipitation in the tundra is low, usually only 50–100 mm per year, although in some areas of the Arctic it can reach 700 mm per year. Most precipitation falls as snow; as a result, tundra habitats are usually snow covered for more than eight months per year. Snow cover is usually thin due to the low amount of precipitation; consequently, frost penetrates deep

■ As in the taiga, soils in the tundra are waterlogged and are also characterised by low rates of organic decomposition. They are humus-rich permafrost (Gelisols), experiencing strong mixing by repeated freezing and thawing of upper soil layers (cryoturbation). Microbial degradation plays a minor role due to the low temperatures. The soils are only of slight thickness, and are acidic and boggy. Soils in the area of tundra bogs are rich in organic material (Histosols). Down-

into the ground. However, rates of evaporation are also low, as a result of the low temperatures and because permafrost prevents the seepage of water into the soil. Tundra habitats are therefore very moist despite the low levels of precipitation.

The growth period for plants is relatively short (6–16 weeks). However, in the summer months this may include 24 hours of sunlight per day, giving plants a long assimilation time despite the short growing season. Subarctic and arctic tundras feature treeless vegetation, dominated by mosses, lichens, grasses and microbial mats, along with isolated herbs and dwarf plants. Due to the short growing season, most tundra plant species have the capacity to reproduce vegetatively. Plant biodiversity is relatively low, with only about 1,000 angiosperm species known mostly from drier sites, such as on hillsides. Most tundra species belong to the Ericaceae, Cyperaceae, and Salicaceae families.

hill soil slippage (solifluction) is common even at gentle hill slopes due to water saturation.

On the basis of the vegetation type, one can differentiate the upper polar lichen and moss tundra from the lower polar dwarf shrub and meadow tundra. In addition to conifers, woody plants found in the tundra are various deciduous trees such as birch and willows; the latter, however, are mostly dwarf shrubs and rarely proper trees. The impact of frost in the winter is slightly lessened due to snow coverage.

assimilation: conversion of matter from the environment into the body's own materials

euthermic: maintaining an optimal temperature

isotherm: (Grk.: *isos* = same, *therme* = heat) line on a map indicating the same temperature

torpor: decreased physiological activity with reduced metabolic rate

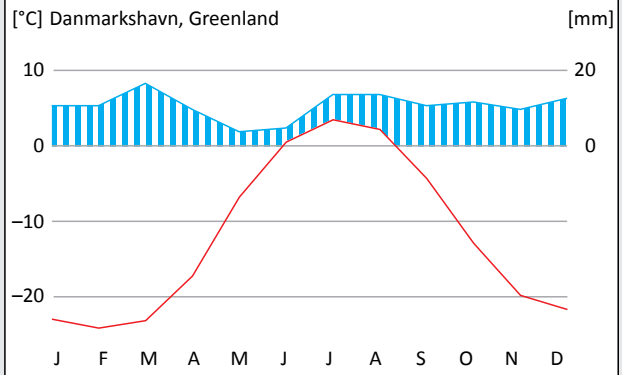
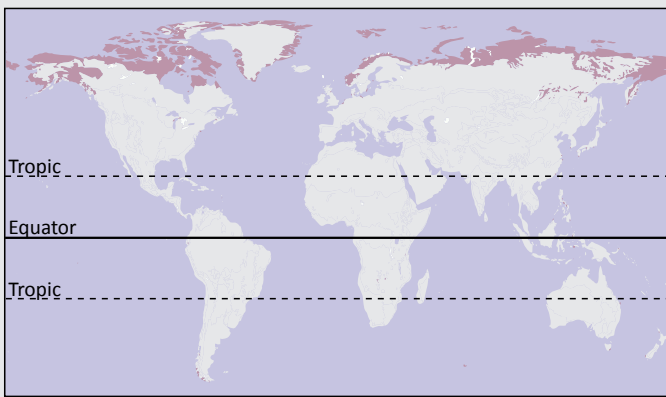

The tundra extends from the polar ice deserts to the boreal forest and is primarily limited to the northern hemisphere. Its climate is characterised by severe frosts, with a short growing season and low precipitation



cryoturbation



Soils in the tundra are usually thin and nutrient poor. Soils on permafrost often thaw in the summer, leaving a wet and boggy habitat. Microbial activity, which is important for pedogenesis (soil formation), is low. Repeated thawing and freezing of the Gelisol leads to cryoturbation (left). The vegetation of tundra is dominated by mosses, lichens, grasses, microbial mats and a few dwarf shrubs. Tall trees are completely absent. Animals avoid the seasonal food shortage either through migratory behavior, as is the case for large herbivores such as reindeer, by storing fat reserves (e.g. musk oxen, right), or through periods of hibernation in or on the ground (e.g. many small mammals)

Survival during winter months can be achieved by reducing activity and energy consumption levels. This hibernation strategy is common in a variety of organisms. It is not even restricted to cold biomes; similar strategies are also common in other climates for survival in extremely dry and hot conditions

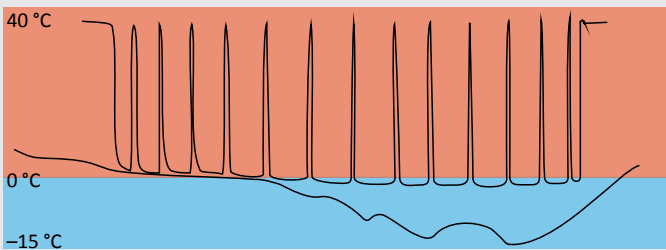

Energy consumption in the cold season can be decreased by lowering body temperature. During hibernation, the European ground squirrel drastically reduces its body temperature in a state of torpor. Its body temperature (upper curve) approaches that of the surrounding soil (lower curve). If the soil temperature drops considerably under 0 °C, muscle contractions raise the squirrel's core temperature to keep it at -2 to -3 °C. Body fluids will not freeze at this temperature. Torpor is regularly interrupted by short euthermic breaks

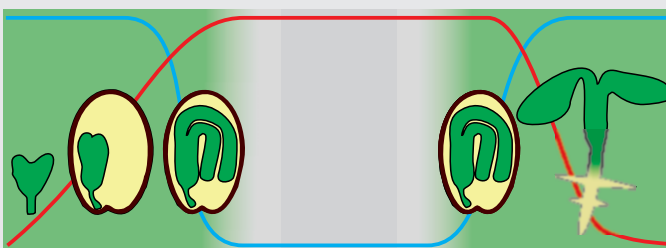

In plants, seed dormancy (a period of general inactivity) is a common strategy during persistent cold seasons. During this time, water content (blue curve) within the seed is drastically reduced, whereas nutrient content (red curve) increases considerably. The further development of the embryo comes to a near halt during this phase. The seed takes on more water at the end of the dormancy period, so that the embryo begins to develop again and eventually germinates



Some organisms, including lichens and cyanobacterial mats, survive complete dehydration or freezing without damage. During such periods they exhibit no sign of life at all (both pictures: the reindeer lichen *Cladonia rangiferina*)



Taiga

■ The boreal forest (taiga) biome is located between the 50° latitude and the Arctic Circle in the northern hemisphere and covers around 7.8% of total land area.

The taiga is characterized by long winters with temperatures dropping as low as to -70°C ; temperatures rise above an average of 10°C only in the three summer months. The vegetation period in the taiga is short, spanning 80–150 days. The longest periods of growth can be found in areas that are close to the ocean, for example in Scandinavia. The shortest growing season, on the other hand, can be found in the taiga's northern continental areas bordering the tundra. The southern border of the boreal coniferous forest is located where conditions are too unfavorable for the growth of deciduous forest; in other words, roughly when average

■ Soils of the taiga are typically podzols. Conifer needles are difficult to decompose, causing thick layers of litter to accumulate on the ground. Many nutrients therefore remain bound in the litter layer and trickle only slowly into the ground, resulting in a dearth of nutrients in the soil for plant growth. The lack of replacement of (alkaline) nutrient ions acidifies the topsoil, with the resulting low pH leading

temperatures do not exceed 10°C for more than 120 days per year. At the taiga's northern boundary, only around 30 days per year have an average temperature of 10°C or higher. Annual precipitation in the taiga is 250–500 mm, with the colder temperatures contributing to the low transpiration rates that keep the water balance positive.

Often just one or two tree species dominate boreal forests, commonly firs, spruces, larches and pines. Blueberry, cranberry and mosses are common smaller plants of the shrub and herb layer. The foliage of conifers is xeromorphic, adapted to cold and desiccation; larches dominate in the particularly cold winters of eastern Siberia because they are able to drop their needles in winter and are thus better adapted to survive severe frosts.

to further leaching of iron and aluminum compounds and of humic substances from the topsoil. These substances permeate the subsoil, where they precipitate and accumulate.

In many areas of the boreal forest, the permafrost only thaws in the upper 50–100 cm of the soil in summer. As a result, and despite the low rates of precipitation, taiga areas are prone to flooding and commonly feature boggy areas.

air embolism: embolism (blockage in a vessel) caused by an air bubble in the vascular system

humins: high-molecular weight substances in humus soil types, including humins (insoluble), fulvic acids (soluble in alkali, acid and water) and humic acids (soluble in alkali)

xeromorph: plant which has adapted to arid habitats

■ **See also:** Ferns: 4.4.3.4; Gymnosperms: 4.4.3.5; Bryophytes: 4.4.3.2

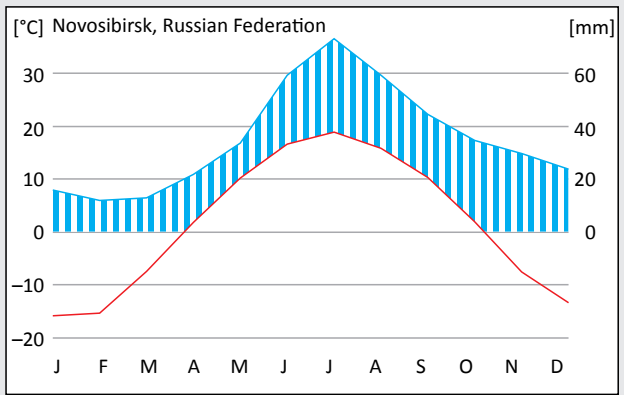
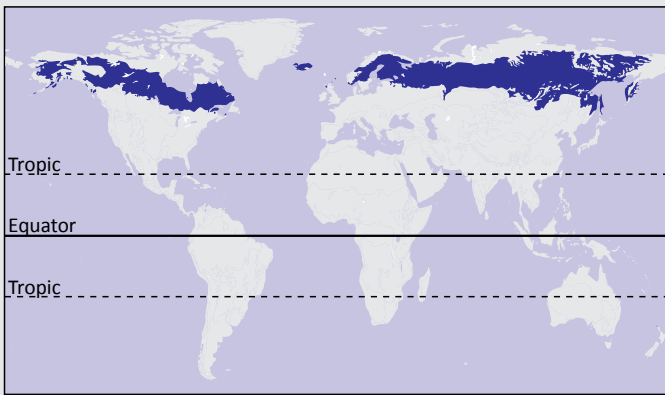

The taiga is the largest forest biome, extending as a belt of coniferous forests around the northern hemisphere. The climate is mostly continental with long, cold winters, and short, warm summers. Precipitation is relatively low (200–700 mm)



acidified soil surface
leached, bleached soil horizon
precipitation horizon



Taiga soils have a slight thickness and are nutrient poor. Decomposing needles from conifers release organic acids, acidifying the topsoil and by that increasing further leaching from the underlying soil through organic acids. Taiga flora is dominated by conifers; its fauna dominantly comprises large, migratory herbivores and hibernating animals

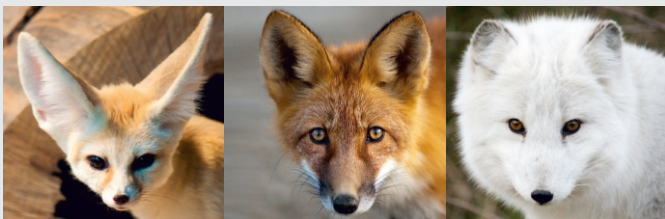

Animals in the taiga are adapted to extreme cold conditions, for example through a compact body. Within a given animal taxon, the size of body appendages become smaller from species living in warm biomes to cold biomes (above, from left to right: the ears of the fennec fox, red fox, and arctic fox). While the big ears of the fennec fox help the animal with thermoregulation in subtropical deserts, the ears of the arctic fox are relatively smaller, an adaptation developed to prevent heat loss and freezing

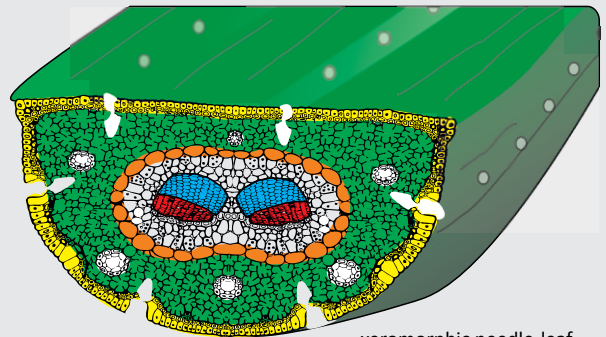

Plants have also developed adaptations to the cold and heavy frosts. During the long winters, plants cannot take in water through their roots and are therefore adapted to survive drought conditions. The leaves (needles) of xerophytes, for example, reduce evaporation by their sunken stomata and by wax deposits on the surface. Xerophytes also keep their needles throughout the winter, a more efficient strategy to avoid growing them anew for each short summer season. The narrow lumen of tracheids of conifers also render them less vulnerable to collapse due to an air embolism caused by frost-induced dryness, as compared to the wide lumen trachea of deciduous trees

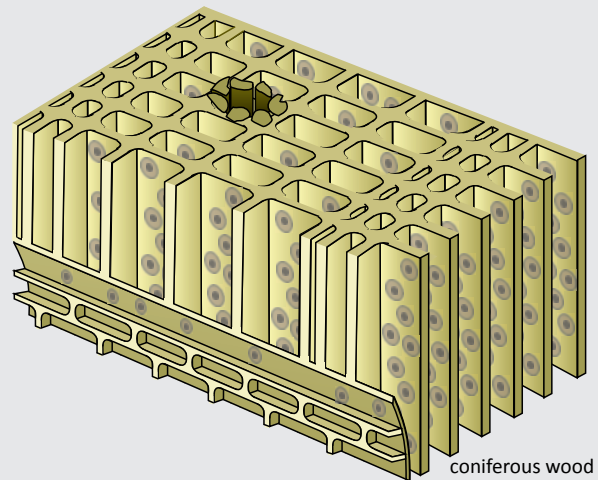



Temperate forests

■ Temperate broadleaf and mixed forests are found primarily in the northern hemisphere on the east coast of North America and in Asia and Central Europe. In the southern hemisphere, temperate forests can only be found on mountain slopes in the Andes and New Zealand. In total, temperate broadleaf and mixed forests occupy 9% and 2.8% of the planet's total land area respectively.

The temperate forest climate is moderate with distinct seasons and short periods of cold in winter. The average temperature exceeds 10°C for four to eight months, and even in the coldest months the average temperature is around 0°C in the oceanic areas but below 0°C in more continental areas. However, during longer winter cold spells, temperatures may fall well below the freezing mark.

■ Temperate forests generally grow on Cambisols (brown soils), layered with an upper soil horizon containing accumulated humus on top, above a horizon characterized by iron oxidation and new mineral formation. Brunification and loamification are characteristic processes of pedogenesis.

Deciduous forest dominates in areas where the mean temperature is over 10°C for over 120 days per year, as opposed to coniferous forests which require only 10–120 such days. As a result, coniferous forests are more common at higher altitude.

The dropping of foliage is a vital adaptation to the winter cold, reducing transpiration and protecting trees from freezing. Transpiration is a particularly important problem, since frozen soils contain very little water for use by plants. High

The four seasons are pronounced, with precipitation peaking during the summer. Total annual rainfall in temperate forest regions lies between 500–1,000 mm, and droughts rarely ever happen.

Deciduous trees with greater frost resistance dominate temperate regions. The greatest diversity of species can be found within the temperate forests of North America and East Asia, while the forests of Central Europe comprise comparatively fewer species. Oak, beech, maple, and birch typically dominate the tree diversity in temperate forests, though in Asia these are occupied primarily by bamboo. Conifers also make up part of the forest biodiversity, including pine, fir, and spruce.

transpiration during periods of frost would therefore damage the plants by frost drought. Budding on trees is prepared in the autumn and opens in spring. Leaf development and the ripening of fruit require a growing season of at least four months. Dropping of foliage is not an appropriate strategy for shortened vegetation seasons; in such conditions adaptations of the leaves to tolerating frost are needed. Conifers therefore dominate in areas with short summers and long, cold winters.

The relatively low species diversity of forests in Central Europe is a consequence of the repeated displacement of species during the ice advances of the Cenozoic ice age and the comparatively limited recolonisation events due to the Mediterranean and European mountain ranges, which blocked colonisation to the south.

browning: process of soil formation in which iron compounds form, thus influencing the colour of the soil

clayification: process of soil formation yielding smaller clasts as the result of silicate weathering and the new formation of clay minerals

frost dessication: dessication (of plants) due to a lack of water as the result of frost, and simultaneous loss of water due to transpiration

hibernation: active/passive strategy for surviving winter in selected mammals

humus: the totality of dead organic matter in soil

nemoral: deciduous

obligatory: necessary, essential

soil horizon: a layer of soil with common physical characteristics differing from the horizons above and below it

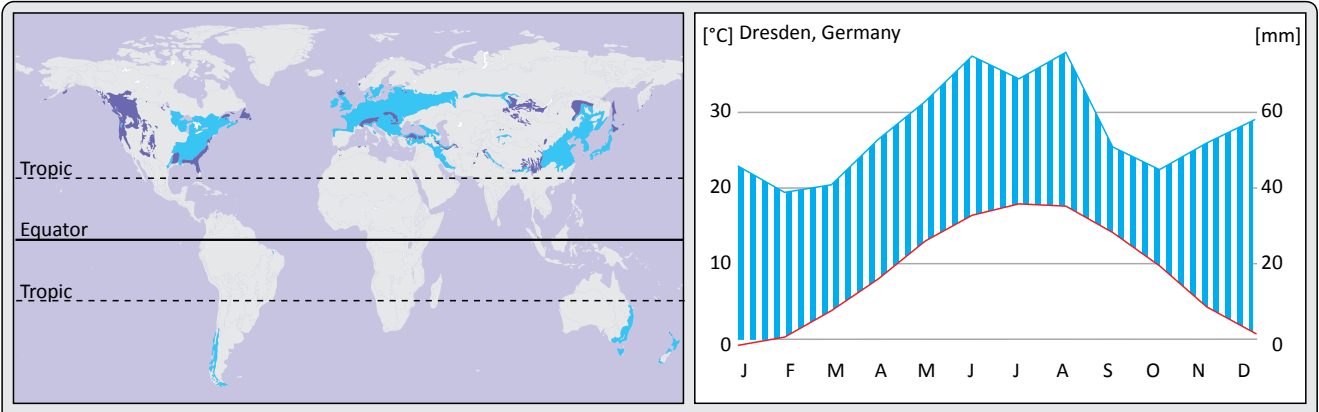

Temperate forests are usually characterised by an oceanic climate. Temperate deciduous forests (light blue) mainly live on the Asian and North American east coasts as well as in Europe. Western North America (dark blue) is populated mainly by temperate coniferous forests

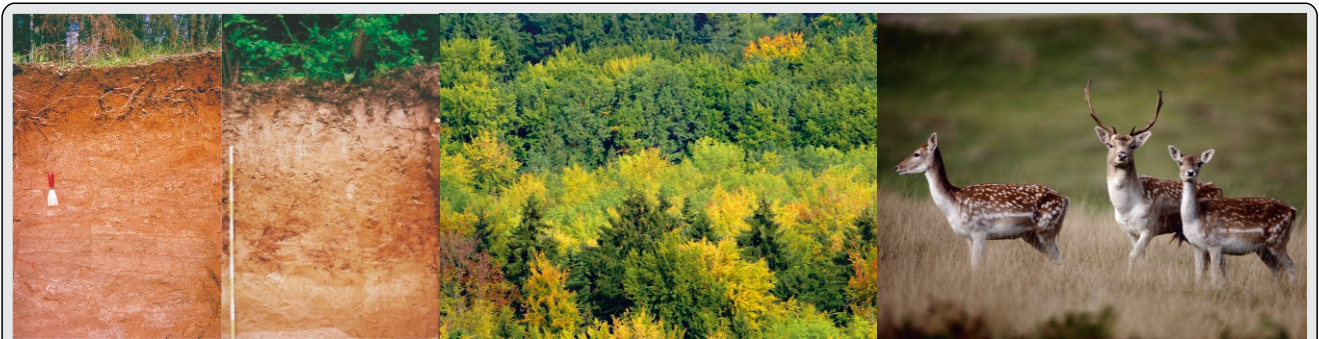

Luvisols and Cambisols are typical soils of temperate forests. Cambisols (left soil profile) mostly occupy a brownish, weathering horizon between the humic topsoil and bedrock. Luvisols (right soil profile) have an upper horizon characterised by low clay and a lower clay accumulation horizon. Trees are favoured due to a lack of pronounced dry seasons. Typical vegetation is deciduous. Big game is active all year round, while many of the smaller animals avoid winter, as in the taiga, by migration or hibernation



The biome of temperate forests is characterised by warm summers and a vegetation period of at least four months. During winter, periods of strong frost are common. Many animals avoid the cold season by migration to warmer climates or by hibernation. The regular frost periods require adaptations of plants such as frost resistance of leaves and wood. Given the long vegetation period (as compared to the taiga) the formation of annual soft but not frost-resistant leaves is usually more efficient than the formation of xeromorphic perennial leaves. The coarse-grained wood of broadleaf trees with trachea allows for an efficient water transport during spring. Sensitivity to frost drought is low due to the temporary frost periods

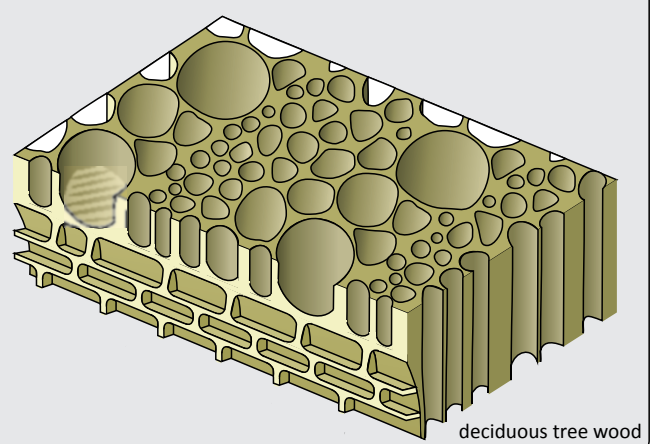



Temperate grasslands

Temperate grasslands and steppes are found predominantly between 40° and 50° latitude. They include the steppes of Russia and Central Asia, the North American prairies, and the pampas of South America, covering around 9.7% of the planet's land area. With increasing aridity, temperate (cold) deserts replace the temperate grasslands. Depending on the definition of the biome in question, the temperate deserts are either combined with temperate grasslands or with hot deserts.

Temperate grasslands experience a continental arid climate, with long, cold winters and short, warm summers. The

Temperate grasslands are dominated by soils rich in accumulated humus, particularly Chernozems (black soils) and kastanozems (brown soils). Chernozems, named after the black colour from the humus-rich topsoil, are characteristic of the humid tallgrass steppes, whereas Kastanozems, named after their maroon colouration, are often found in more arid, shortgrass plains. These soils are formed from calcareous materials subsequently mixed intensively by soil-dwelling animals through the process of bioturbation. Climatic fluctuations, especially phases of drought or frost, reduce the degradation of organic matter, leading to the accumulation of humus and the creation of a humus-rich topsoil. Kastanozems are formed under similar conditions compared with the Chernozem soils, though in slightly more arid

average temperature of the coldest month is below -10°C with long periods of heavy frost. In the summer, the average temperature for at least four months is above 10°C .

Rainfall in temperate grasslands is lower than evaporation rates, with annual precipitation between 100 and 400 mm.

Because of the low precipitation during the warm season, tree growth is hardly possible. Instead, temperate grasslands are dominated by steppe and desert vegetation, with adaptations to resist frost conditions.

Leaching is hardly present at all in these soils, though rising groundwaters can cause these soils to become more carbonate-rich.

Grazing is of central importance to grasslands, preventing the emergence of hemicryptophytes and a build-up of litter. As a rule, underground biomass is greater than that found above ground. Wetter areas are more likely to contain tall grasses, whereas shorter grass grows best in drier regions.

Herbivores make use of two strategies to deal with drought conditions. Large herbivorous species, such as buffalo, may migrate great distances in order to find a seasonal food supply. Smaller herbivores, on the other hand, such as prairie dogs, tend to rest under the earth during unfavourable seasons.

arid: dry

hemicryptophytes: plants with a growth-point (bud) near the soil surface

humid: relatively high level of water vapour in the atmosphere

plant litter: dead organic material on the top layer of soil

shortgrass prairie: prairie dominated by short grasses

tallgrass prairie: prairie dominated by tall grasses, such as that native to central North America

See also: Savannah: 3.2.2.10

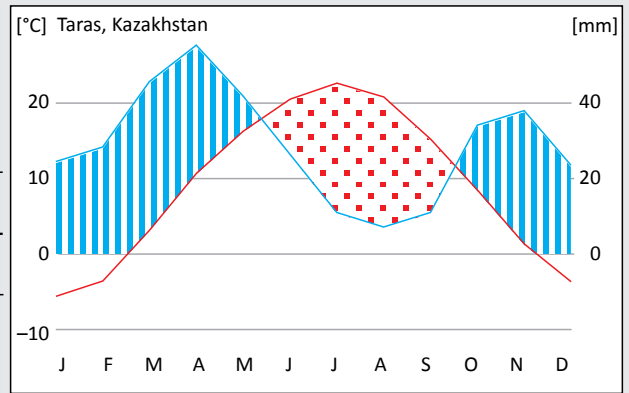
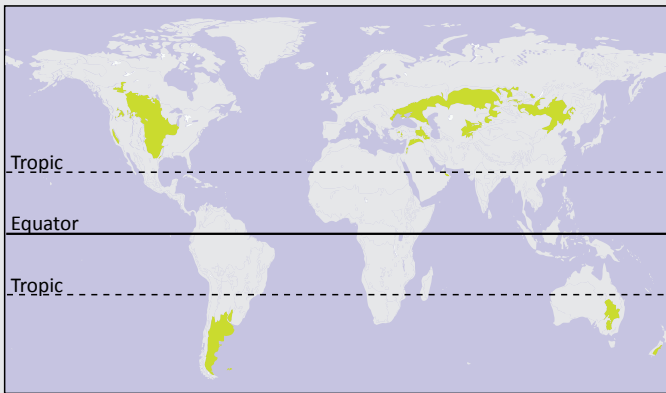

Temperate grasslands are located in the temperate latitudes, in intracontinental locations or in the lee of mountain ranges. The climate is characterised by a pronounced dry period, usually in the summer



Deep, humus-rich soils are typical of temperate grasslands. The soils of humid grasslands are particularly deep and rich in humus, visible by their black colour (Chernozems, left profile). The soils of the drier, shortgrass plains are usually slightly more shallow and not as rich in humus, and therefore more brown-coloured (Kastanozem, right profile). Grasslands dominate this biome because the shortened growing season, which is usually shortened by a summer dry period, makes it more difficult for trees to grow. Large herbivores manage to live through periods of drought by migrating



Shortgrass steppes dominate precipitation-poorer regions (left), comprising mainly annual grasses, which rarely grow taller than half a metre. The grass seeds enable the species to survive dry periods. Tallgrass steppes (middle) are characteristic of wetter regions, where grasses, like the pampas grass (right), can grow to over two metres in height. These grasses are usually horsetail grasses and perennial



Several species rest during dry periods: grasses form renewal buds and spurs close to the ground (left and middle) and many animals – especially smaller ones that cannot avoid drought by migration – spend most of their time underground (right: prairie dog)



Montane and flooded grasslands

■ Montane grass and bushlands are found in tropical, subtropical, and temperate climates in the montane and alpine altitudes. They are particularly common in the South American puna and paramo, as well as in the steppe areas of Tibet. Montane grass and bushlands account for around 4% of the planet's total land area.

As is common at altitude, climatic conditions in these areas are usually cool and moist, with high levels of sunlight.

Montane grassland plants exhibit typical adaptations, including rosette growth forms, hair, and wax deposits on the surface. Species are often endemic, especially in grass and bushlands in isolated small mountain areas, such as at Kilimanjaro or Mount Kenya. Horst grasses are also typical. The grass and bushlands of humid (tropical) regions are often referred to as paramo, whereas the drier (subtropical) regions are known as puna. These terms are derived from the regional designations of the grass and bushlands of the Andes.

■ Montane and flooded grasslands are special locations, where climatic conditions differ greatly from zonal ones.

Temperatures decrease with altitude by around 0.6°C per 100 m, though at the same time solar radiation increases with height and the colour spectrum of the available sunlight shifts towards a higher ultraviolet (UV) component.

Despite higher rates of rainfall, montane sites are often relatively dry since precipitation flows quickly through the

Flooded grasslands are found on several different continents, mainly in subtropical or tropical climates. Some of the most well-known such areas are the Everglades, the Pantanal and the Niger, as well as the Okavango Delta. Flooded grasslands make up only around 0.7% of the planet's total land area.

Flooded grasslands are usually formed around tropical or subtropical rivers in lowland areas of river deltas. They form a network of flooded grasslands, often just a few centimetres deep but with a width of up to several hundred kilometres, of deeper water basins and islands.

Temperatures are often tropical to subtropical, and the precipitation has very little impact on the formation of vegetation, since the floodplains are fed by larger rivers.

Grasses grow in the low water level areas of flooded grasslands, though trees are known to grow at higher ground levels. The fauna is dominated by amphibious animals and birds.

slope. In addition, soils usually succumb to high erosion rates and do not store much water.

Soils in flooded grasslands, on the other hand, are largely cut off from atmospheric oxygen supplies and are therefore anaerobic. Above-ground organs supply the rest of the plant, including the roots, with oxygen.

Since flooded grasslands predominantly occur in low altitudes, their climatic conditions correspond to the zonal climate conditions.

endemic: occurrence of organisms within a defined restricted geographical area

tussock grasses: grasses which grow close together in tufts or clumps

■ **See also:** UV protection: 4.2.1.7

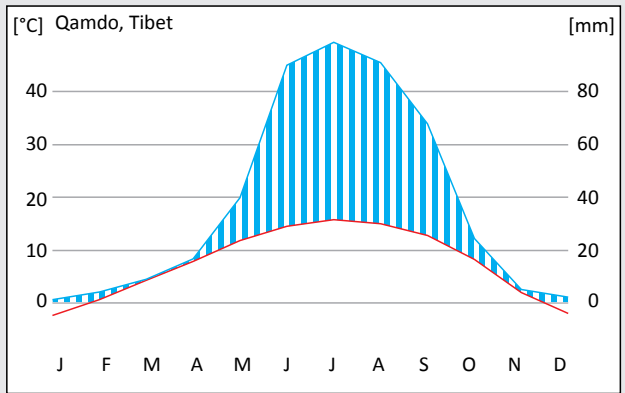
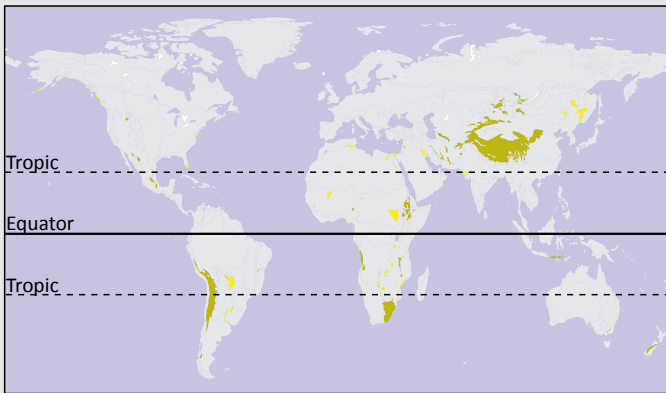

Montane grasslands occur as a result of mountain ranges and not because of particular zonal climates. Flooded grasslands, too, are formed as a result of geomorphological factors rather than climate



Montane locations are unique, with temperatures decreasing as altitude increases whereas irradiation corresponds to the zonal conditions, *i.e.* the latitude. However, the relative contribution of UV increases with height. As a result of high levels of rainfall, erosion is strong and consequently soil formation is generally weak. Vegetation is dominated by herbaceous plants (left: *Gentiana*) and cushion plants. Animals migrate seasonally (above: ibex) or hibernate

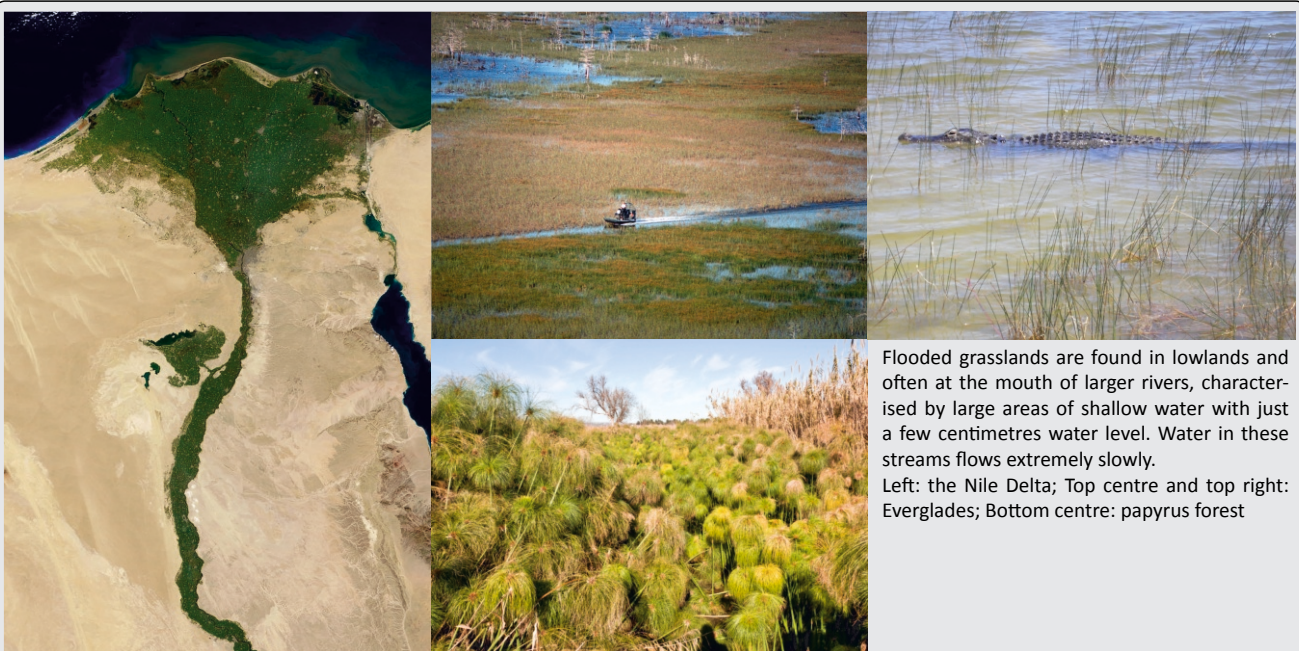

Flooded grasslands are found in lowlands and often at the mouth of larger rivers, characterised by large areas of shallow water with just a few centimetres water level. Water in these streams flows extremely slowly.

Left: the Nile Delta; Top centre and top right: Everglades; Bottom centre: papyrus forest



Mediterranean biome

The Mediterranean biome is found mainly between 30° and 40° latitude on the western edge of continents, covering around 3% of Earth's total land area. Most of it can be found on the coasts of California and Chile, as well as the south-western tips of Africa and Australia.

The Mediterranean climate regions lie between the subtropical desert areas and temperate regions, and are characterised by winter rainfall and summer drought. In contrast with tropical regions, the Mediterranean biome experiences rare instances of frost. Annual precipitation is around 500–1,000 mm, with for the most part around five humid months per year. The Mediterranean vegetation period lasts for five to nine months. Temperatures are highly variable, from freezing

During summer periods, Mediterranean biome regions experience subtropical anticyclones, with correspondingly low rainfall. In winter, in contrast, they experience low pressure levels and high rates of precipitation. Litter composition rates are relatively high as a result of the mostly high temperatures during the winter rainy season. Loamification is common, limestone and salts are often accumulated in soils. The most commonly found Mediterranean soils are calcium-rich, such as the Calcisols, cobbly soils of slight thickness (Leptosols) as well as soils with lessivation characterised by horizons of low and high clay, respectively (Luvisols).

Fire plays a major role in the Mediterranean biome and its incidence has risen sharply in recent decades due to anthropogenic influences.

Highlands are dominated by forests, which, with increasing altitude, shift from evergreen forest at low altitude to deciduous forests, eventually being replaced by coniferous forests at high altitude. Xerophyte abundance increases with

in winter to over 40°C in the summer, and rainfall intensities also vary greatly. Monthly mean precipitation levels may be reached within a single or few heavy precipitation events.

Mediterranean vegetation ranges from forest areas to steppes. It must withstand long periods of drought and short frosts. As a result, many Mediterranean plant species have thick, hard leaves (sclerophytes) with a thickened epidermis and a pronounced cuticle layer. Areas of winter rain comprise, along with the humid tropics, some of the most biodiverse regions on Earth. To that end, the Mediterranean vegetation of southern Africa ('fynbos') is its own floral kingdom, known as the capensis.

aridity; the typical shrub- and tree-shaped xerophyte vegetation is strongly influenced by humans in many areas.

Laurel forests dominate warm-temperate, perhumid areas. In some classification schemes they are classified as a separate biome, in other schemes as a part of the subtropical evergreen forest (WWF classification) or of the Mediterranean biome. The temperature fluctuations in the laurel forests are lower than in the Mediterranean biome. Conditions are humid and mostly frost-free throughout the year; long periods of drought are uncommon. Laurel forests are evergreen and therefore contrast greatly with deciduous forests. They also differ from tropical rainforests since they tend to have less complex layers of vegetation and generally less dense vegetation. They can be found on the east coasts of continents around 25° to 35° latitude, in particular in California, southern China, south-eastern Brazil, as well as in the south-east of Africa and Australia.

Calcisol: soil that possess a strong secondary calcic horizon
heavy rain: intensive precipitation over a certain time span; over 10 mm precipitation per hour
hematite: Fe_2O_3 , a common iron oxide
humid: relatively high level of water vapour in the atmosphere

perhumid: extremely wet climate, including ten to twelve humid months
plant litter decomposition: breaking down and mineralisation of organic substances by decomposers
sclerophytes: evergreen arboraceous plants in the tropics and subtropics which have adapted to periods of drought

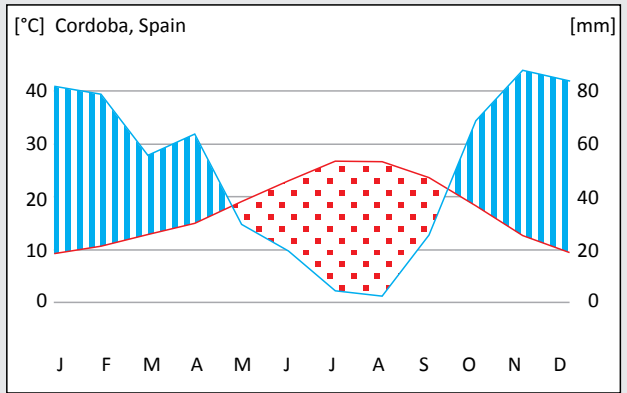
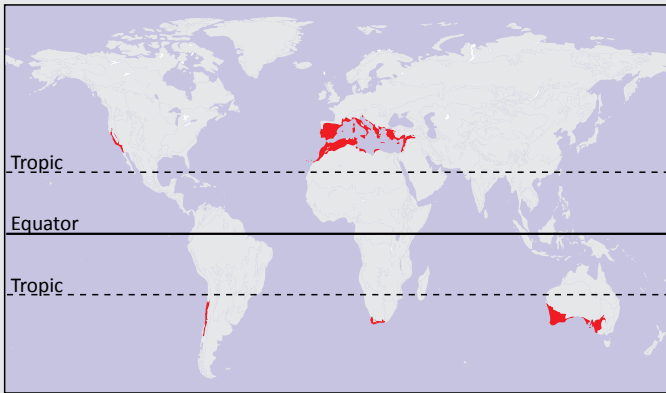

Mediterranean forests and bushlands are found on the western edge of continents between 30° and 40° latitude. They are characterized by a longer, marked dry season in the summer. In winter, temperatures are generally above freezing with occasional periods of frost



clay-depleted horizon
clay accumulation horizon
clay horizon extending into conglomerate rock



In the wet winter months, the upper horizon of Mediterranean soils decalcifies as a result of carbonate solution. As a result, clay is relatively enriched (residual clay) in the upper horizon of these soils (Cambisols). During moist periods of winter precipitation, clay minerals eluviate from the upper soil horizon to deeper layers. These soils are called Luvisols (referring to the displacement of clay). They are often deep red as a result of the weathering of silicates and recrystallisation of the released iron oxides. Local flora and fauna show adaptations to the dry, hot summer conditions

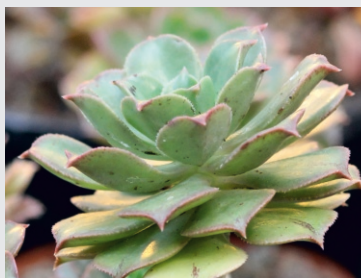

Succulence is a common adaptation of crops to the summer dry season (left: *Aeonium* sp.). Cold-blooded animals are typical in the frost-free climates (right: green lizards)



The bushland of the South African Cape region is known as the fynbos ('thin bush'). The Cape area is one of the most species-rich floral regions in the world



Laurel forests are the typical vegetation of the warm temperate perhumid area. They are considered as independent vegetation zones in some classification schemes



Hot and temperate deserts

Hot and temperate deserts occupy around 13% and 10% of the planet's surface area respectively. Depending on the exact definition, they are grouped as single or separate biomes, characterized by their low rates of precipitation.

Hot deserts extend approximately between 20° and 25° latitude to the north and the equator to the south. Their average temperature is over 10°C for eight months per year. The largest hot deserts on Earth are the Sahara in North Africa, the Namib in South Africa, and the Great Indian Desert in Pakistan.

In temperate deserts the average temperature is above 10°C for four to eight months, with little or no rain throughout the year. Temperate deserts often lie in the lee of large mountains or at the interior of large continents; for example, the Gobi Desert in Asia or the Great Basin Desert in the US.

Deserts result from conditions of low moisture and rainfall. A warming of the climate, as is currently taking place, will, however, not lead to desertification, but rather to the creation of more grasslands: global warming leads to increased evaporation rates and therefore to increases in precipitation. In desert areas, precipitation rates are higher than evaporation.

Climate change, which includes increases in atmospheric carbon dioxide concentrations, will allow plants to open their stomata for a shorter period of time to carry out photosynthetic functions, thus enabling them to greatly reduce wa-

ter loss. As water will become more available to some plants inhabiting regions that border desert areas, they will in future be able to expand further into desert habitats. The flora and fauna of deserts is sparse. The few plants and animals that can live in desert conditions are specially adapted to the long-lasting arid conditions. For example, plants are adapted to store water (succulence), reduce evaporation (wax deposits, thick cuticle, C₄-photosynthesis, reduction of leaves), and develop annual strategies. Animals also have a set of specific adaptations to desert conditions; for example, by reducing the amount of water they excrete (for example, desert mice have an extended loop of Henle in the kidneys) or through behavioural strategies that minimise their activity during the hottest times and seasons.

Many desert plants and animals, especially those inhabiting coastal areas, which regularly experience periods of morning fog, have developed ways of extracting moisture from the air.

Chemical weathering processes are stronger than microbial degradation, which is heavily restricted by the arid conditions in deserts. Desert soil, furthermore, is poorly differentiated and in early developmental phases. Nutrient-poor regosols are widespread in the desert aridity, highly susceptible to erosion. Saline soils (Calcicol, Solonchak, Gypsisol) and soils with secondary silicate enrichment (Durisols) are also widespread.

chemical weathering: processes leading to the chemical alteration or dissolution of minerals

undifferentiated soils: soils are not or only weakly differentiated into horizons

stomata: pore in a plant which serves to regulate gas exchange with the environment; the resultant transpiration cools the tissue

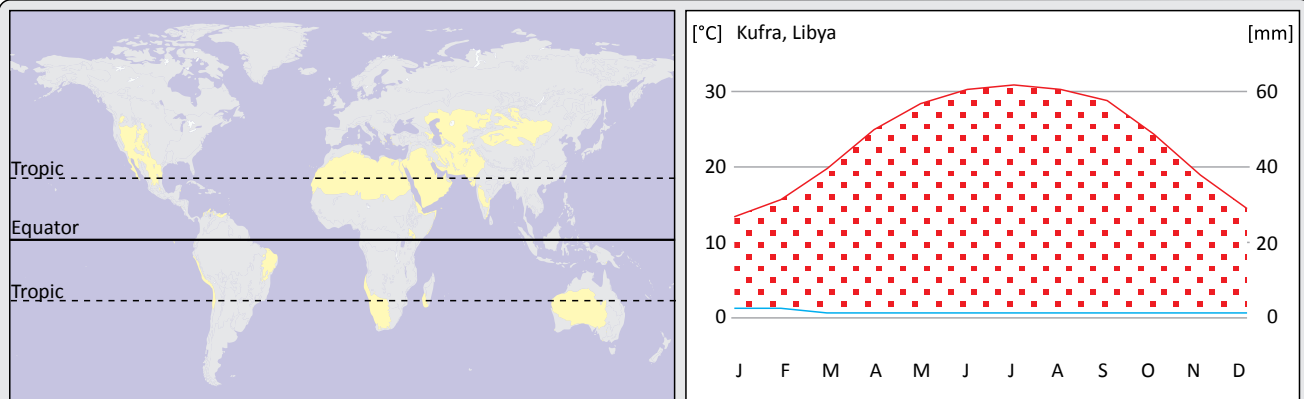

Deserts extend along the subtropical climate zone and in the rain shadow of large mountain ranges. The desert climate is characterised by arid conditions throughout the year. Subtropical (hot) and temperate (cool) deserts are considered to be independent biomes in other schemes

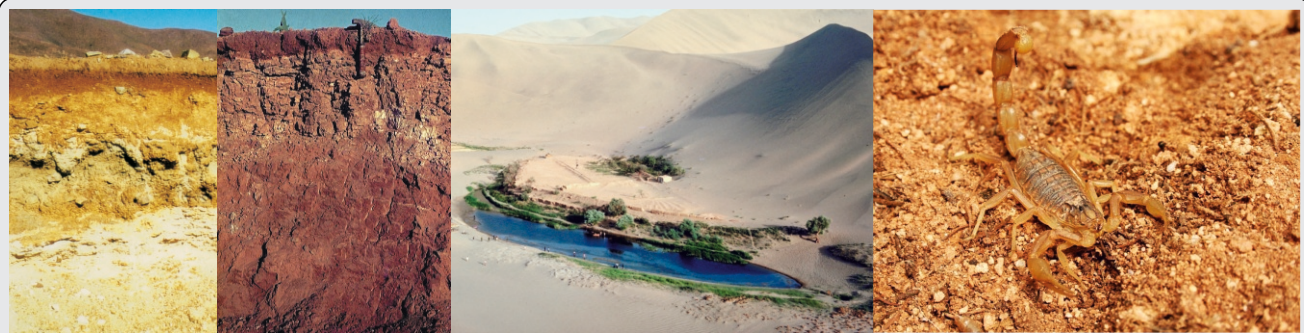

Desert soil formation is driven by drought conditions. Salt accumulations are common in topsoil, including enrichment of carbonates (left soil profile: Calcisol), gypsum (Gypsisol) or mixtures of chloride, sulfate, carbonate and nitrate (Solonchak). Silicate-rich soils are known as Durisols (right soil profile). The dry conditions do not allow most vegetation to occur. The lack of vegetation, erosion, and wind displacement of particles causes the formation of dunes. Most animals are adapted to nighttime activity, in order to avoid the hottest periods of the day



Adaptations to the dry and often hot desert climate relate primarily to the regulation of water supply. This includes the formation of deep roots (middle: *Welwitschia*) and succulence, which helps improve storage rates of water within plant tissues and which is often associated with adaptations to reduce evaporation (left: living stones). In animals, examples are behavioural and physiological strategies, such as highly concentrated urine in order to minimize the excretion of water (right: gerbil)



Succulent growth forms, an adaptation to the desert climate, have evolved in various plant families. Left: the euphorbia *Euphorbia canariensis* and *Euphorbia horrida*; right: the cactii *Pachycereus weberi* and *Echinocactus grusonii*



Subtropical and tropical grasslands

Tropical and subtropical grasslands occupy around 14.3% of Earth's terrestrial landscape, lying mainly between 5° and 20° (north and south) latitude. Their precise boundaries are difficult to determine, as transition into drier forest areas is smooth.

Tropical and subtropical grasslands experience semi-humid to semi-arid conditions during the summer rainy season and a cooler winter dry season. Average temperatures are over 10°C for at least eight months per year. Summers are hot and humid. Precipitation rates are between 600 and 1,500 mm, though as low as 200 mm in border desert areas. During the dry season, evaporation rates are, in general, higher than precipitation, though for the most part, and es-

The savannas border areas and the drier forest habitats experience a summer rainy season and winter drought. In winter, savanna areas fall under the influence of subtropical high pressure areas, leading to a pronounced drought. In the summer, however, the same regions are influenced by the intertropical convergence zones, leading to heavy and regular rainfall.

Humid savanna experiences a relatively high 1,000–1,500 mm of rainfall, with a drying time of only three to five months. As a result, the vegetation is comprised mainly of tall grasses, for example elephant grass, which grows to a height of 6 m, as well as sparsely distributed trees (and open to partly closed forests).

In drier savanna areas precipitation is between 500–1,000 mm, with a drying time of five to seven months. The vegetation is characterised by medium-height grasses and many plants display adaptations to the drought conditions.

In xeric shrublands precipitation can be as low as 250–500 mm, with drought periods of up to 10 months per year. Grasses remain short (under 30 cm) and cover only partial areas. The climate is usually too dry for trees; thorny bushes dominate the landscape and are mixed with other plants

pecially in areas of xeric shrubland, the opposite is true. The dry season lasts between three months near tropical areas and 10 months in regions bordering desert.

Tropical and subtropical grasslands include a range of habitat transitions, from acacia-dominated areas, drylands, treelined savanna, as well as xeric shrublands. However, of these, the most common are probably the treelined savannas, comprising grasslands and scattered trees. The herbivores present in such habitats are usually large, migratory herd animals, including antelopes, giraffes, and elephants. The proportion of small rodents, which generally inhabit the soil, is lower compared with in temperate grasslands.

adapted to heavy drought conditions, including succulents, geophytes, and ephemerals. Fungi are far less common than in the humid tropics. Termites play an important role within such arid ecosystems, building effectively using plant biomass; as a result, savannas are characterised by a high metabolic rate, despite their aridity.

Savanna soils are characterised by high clay content (vertisols) and have high proportions of iron minerals and a strong reddish or yellow-brown pigment. The clay minerals in the soil regularly contract and expand as a result of the fluctuation between dry and wet periods: during the dry season, cracks and crevices up to half a metre deep may be visible. These are subsequently filled again when the next rain causes the soil to swell. This pedoturbation prevents the creation of an even vertical soil profile. Apart from vertisols, the savanna contains soils that display relatively strong clay leaching: as a result of the degradation of organic matter by termites and the sparse vegetation cover, coupled with the availability of cations, clay particles are suspended and stored in deeper soil layers at the onset of the rainy season. The resulting soil profile features an upper horizon poor in clay above a lower clay-rich horizon characterized by Acrisols or Luvisols.

Acrisol: extensively eroded, red-coloured acid soil with accumulated subsurface layers of clay, this soil group is produced by extensive leaching

ephemeral: (Grk.: *ephemeros* = for one day) having a short life span

geophyte: plant with concealed storage organs

Intertropical Convergence Zone (ITCZ): low-pressure trough near the equator where the northeast and southeast trade winds converge

Luvisols: soil with eluvial horizons which are not as leached or acidic as acrisol

pedoturbation: soil perturbation not caused by illuviation (the re-distribution of water)

semi arid: mostly arid climate; evaporation is greater than precipitation over six to nine months

semi humid: mostly humid climate; precipitation is greater than evaporation over six to nine months

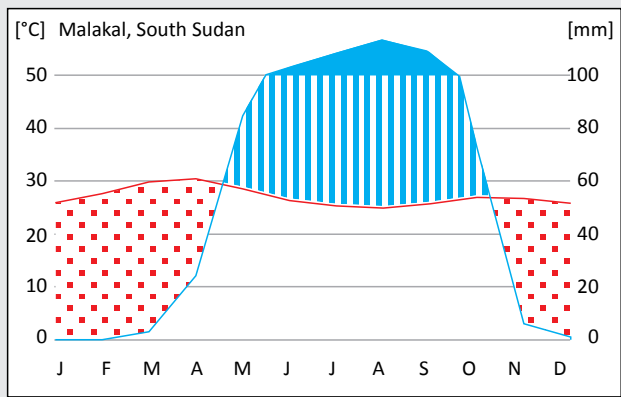
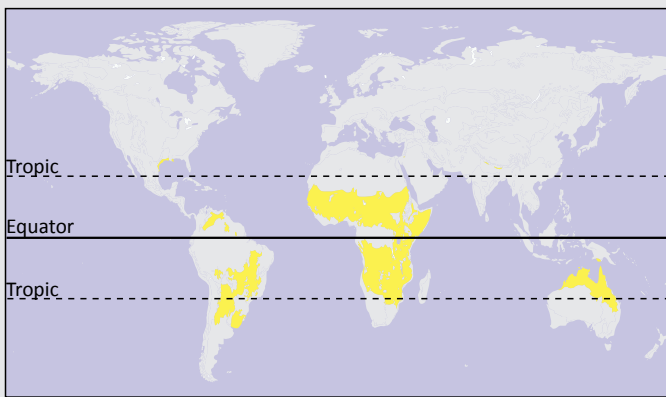

Tropical grasslands are widespread on both sides of the equator between 5° and 20° latitude. Their transition to bordering dry forests is fluid. Seasonal variations are low, with a climate characterised by fluctuations between a summer rainy season and a dry season in winter



The periodic wetting of the soil in high temperature causes a strong chemical weathering. The soil which is relatively humus-poor as a result of termite activity. In dry savanna and treelined savanna areas, heavily weathered, humus- and clay-poor surface layers sit atop clay-rich layers (left soil profile: Lixisols). During the dry season, cracks form within the clay-rich soils found on plateaus and at the foot of slopes (right soil profile: Vertisols). Macrofauna is dominated by large herbivores that migrate as a result of seasonal rainfall and the need to find food



Grasslands are regularly exposed to wildfires. The fires encroach on bushlands and threaten trees, engulfing large amounts of biomass each year. Microbial degradation is relatively low in grasslands, since biomass is mainly obtained at the beginning of the dry season and microbial degradation is less efficient in arid habitats. Termites are responsible for much of the degradation of plant biomass in tropical grasslands (top-left: termite mounds; bottom-left: termites). Termites are also able to build from the resulting biomass during the dry season. Cellulose is broken down by anaerobic bacteria and protists (for example, Metamonadida) living within the termite gut. Methane is also produced by the anaerobic activity within the termite gut; as a result, termites account for a significant proportion of methane-based greenhouse gases. Whereas termite activity on the one hand lowers the humus content of the soil, it contributes to bioturbation, or mixing of soil layers



Subtropical and tropical arid (xerophytic) forests

The arid forests found on the northern and southern borders of rainforests are found between 5° and 15° latitude. The transition of older, drier forest areas to savannas is fluid and may in itself be defined differently depending on varying biome definitions. Particularly in Africa, anthropogenic activities are increasingly turning dry forests into savanna.

Tropical and subtropical arid broadleaf forests make up around 2.1% of Earth's land area, whereas the subtropical and tropical coniferous forests occupy 1.1%.

Their climate is subtropical or tropical, with average temperatures reaching above 10°C for at least eight months per year. Annual precipitation is between 1,000 and 2,000 mm, with a pronounced dry season of several months in winter.

The shift between dry and rainy seasons is related to sunlight patterns: during the northern summer, the sun rises perpendicularly along the Tropic of Cancer and not the equator. As a result, ascending, evaporating air masses at the Intertropical Convergence Zone migrate towards the north and rainfall is therefore very high there in the summer. In the northern winter, the sun rises fully along the Tropic of Capricorn, thus causing lower precipitation patterns in the north and higher rainfall south of the equator.

Some areas, which experience a shorter dry season of three to five months, are characterised by the growth of deciduous forest. Rainfall decreases and the length of dry seasons increases with distance to savanna areas.

During the dry season, trees lose their leaves in order to reduce evaporation rates. Their roots are also relatively deep, relying on groundwater during the dry season. As a result of the loss of leaves, sunlight reaches the ground in the dry season, allowing for a relatively dense undergrowth compared with evergreen rainforests.

The total species diversity is lower than in evergreen rainforests, however, though still relatively high.

Soil fluctuates from permanently humid in summer to arid in winter. It is dominated by highly weathered Acrisols, Alisols, and Ferralsols; in other words, highly iron- and aluminium-rich soils. Since leaves fall at the beginning of the dry season, their accumulated organic matter is barely broken down by microbes. Instead, the nutrient cycle at the soil litter level is driven by remineralisation by fire and dispersal by termites.

Acrisol: extensively eroded, red-coloured acid soil with accumulated subsurface layers of clay, this soil group is produced by extensive leaching

Alisol: acidic soil caused by leaching with accumulated subsurface layers of clay, less eroded than Acrisols

Intertropical Convergence Zone (ITCZ): low-pressure trough near the equator where the northeast and southeast trade winds converge

undergrowth: vegetation in a forest growing underneath the canopy

See also: Temperate forests: 3.2.2.5

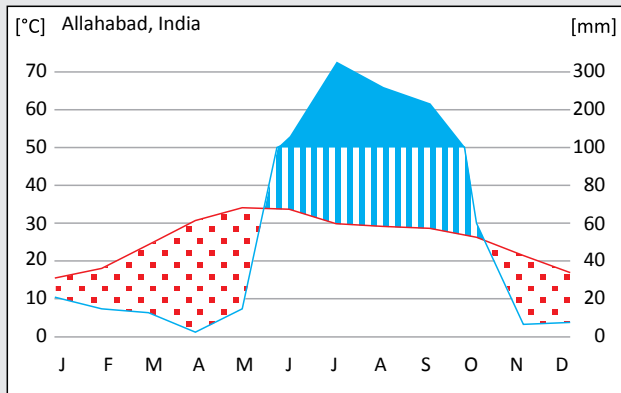
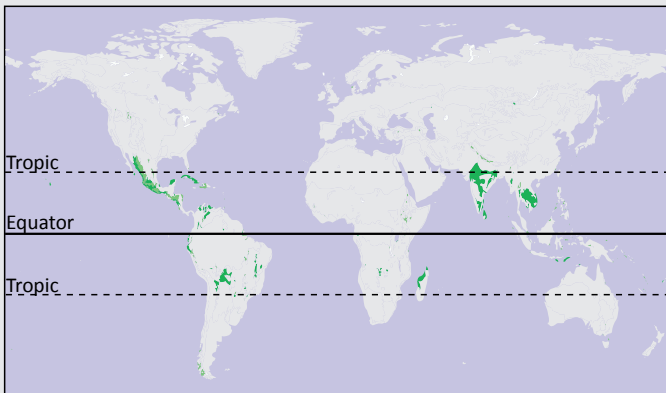

Arid forests form at the transition between tropical grasslands and rainforests. Due to human activities, such as deforestation and planned fires, dry forests are increasingly rare. Their climate is similar to that found in savannas, but slightly more humid

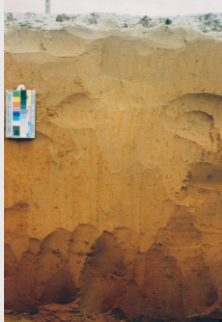

eluvial horizon (clay leaching horizon)

clay enriched horizon



The predominantly humid conditions cause clay to leach from upper layers of the soil and to accumulate deeper down. Typical soils include Acrisols, poor in humus and acidity. Arid forest tree species drop their leaves seasonally as a result of water availability and not, as is the case in temperate deciduous forests, because of temperature variations



A number of species are adapted to the transition between savanna and rainforest: top: half-evergreens in Australia; bottom: monsoon forest in India

Human activity, such as artificial fire and deforestation for the production of firewood, causes half-evergreen forest to turn into savanna (bottom-left) and semi-arid (bottom-right) regions



Tropical rainforest

Tropical rainforests comprise about 15.3% of the planet's land area and stretch around the equator and 5–10° latitude in each direction. The major areas of rainforest occur along the Amazon Basin in South America, the Congo Basin in Africa, and the Malay Archipelago and Pacific Islands.

The rainforest climate is formed by westerly wind zones in continental equatorial regions. As the clouds rain down on the westerly side of continents, precipitation rates lower in eastern areas. As a result, rainforests are rare near the east coast of South America and Africa.

Tropical rainforests do not experience frost at any time of the year. Average monthly temperatures near the ocean are above 18°C and within lowland rainforests range between 24 and 30°C. In general, seasonal temperature variations are low: the annual amplitude, the difference in average temperatures between the coldest and warmest months, is often a maximum of 5°C.

Precipitation rates are high in tropical rainforests, ranging between 1,000 and 15,000 mm with an average of roughly

The humid daytime air of tropical rainforests results from the year-round nearly vertical sun. The climate is largely diurnal, meaning that the temperature fluctuations between day and night are higher than seasonal variations at the same location.

Evaporation is high as a result of the strong sunlight. The rising warm air cools with increasing height, forming clouds and subsequently rain. Especially in areas that are further away from the equator, the intensity of precipitation changes seasonally as the sun's position shifts.

The diversity of trees in tropical rainforests is very high, with over 300 different species able to grow in a single acre. However, many of these species are commonly represented by just one individual. Important plant families include the *Arecaceae* (palms), *Moraceae* (including the figs), and *Piperaceae* (pepper family). In the neotropics *Bromeliaceae* (bromeliads) also dominate, as the *Pandanaceae* do in the paleotropics.

3000 mm. Although precipitation intensity fluctuates seasonally, there is no pronounced dry season, with shorter dry periods lasting a few days to a few weeks. Evaporation rates are low, due to the high humidity, and as a result plants do not experience water stress.

Tropical rainforest vegetation is dominated by tall trees which, as a result of the lack of seasons, have no annual rings. In surface-weathered soils the trees are often shallow-rooted, stabilized by the formation of buttress roots. Moving up from the surface, three layers of rainforest trees are commonly formed: a 20–30 m lower tree layer, a 30–40 m main crown layer, and the 50–70 m high giant trees. A roughly 15 m shrub layer grows among these layers. There is no herb layer in tropical rainforests, as no light (<1% of total) penetrates to the forest floor. Mangroves dominate tropical rainforests at coastal areas, where high salinity levels and water level fluctuations make it more difficult for normal trees to grow.

The high humidity combined with high temperatures favours microbial conversion processes in the soil. Leaf litter and other biomass are therefore degraded quickly and, as a result, the humus and litter layer of the soil tend to be relatively shallow. The soil is acidified to pH values of 4–4.5 as a result of chemical weathering and leaching. Iron and aluminium oxides are created. The main minerals found in tropical rainforests are goethite in the topsoil and hematite in subsoils. Silica-depleted kaolinite forms by argillaceous alteration of silicates, further desilication results in the formation of aluminium oxides – this process of desilication is known as loamification. The combined enrichment of iron and aluminium (ferralinitisation) and depletion of silicon (desilication) is known as lateritisation. The soils in tropical rainforests are therefore usually Ferralsols (German classification=laterites; US classification=oxisols).

buttress root: large, rib-like roots arranged in a star formation around a tree to increase stability

desilification: part of the process of silicate leaching which produces orthosilicic acid

leaf litter: mostly undecayed dead plant material on the ground

mangrove: ecosystem in tropical mangroves; saline-tolerant trees and shrubs in a mangrove

perhumid: extremely wet climate, including ten to twelve humid months

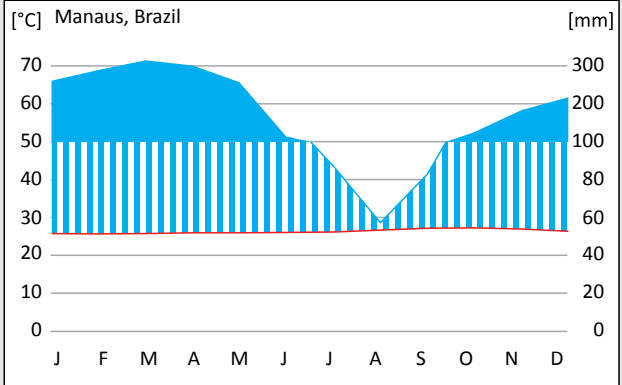
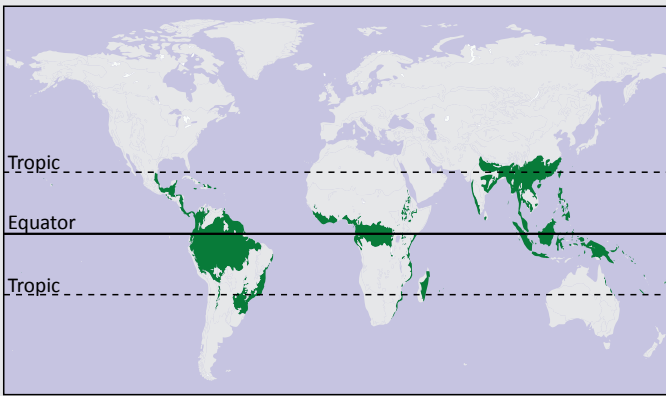

Tropical rainforests are found on either side of the equator on the side of continents with the highest precipitation rate. The climate is warm and humid throughout the year. Daily fluctuations in temperature are greater than those between seasons (diurnal climate)



the process of ferralisation leads to a reddish to yellowish 'ferralitic' horizon

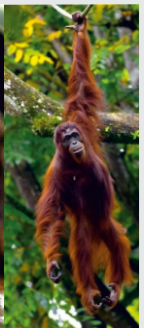

The permanently humid warmer climate favours deep chemical weathering of the soil, often down to 50 m in depth. The weathering of silicates leads to the accumulation of iron oxides. Typical soils are mostly red or yellow Ferralsols (left). The forest is organised in layers, comprising giant trees, the main canopy, a lower tree layer, and a shrub layer. Little light penetrates all the way to the ground; as a result, grass is unable to grow. Animal life is adapted to the trees



In contrast to the sparse layer of grass, epiphytes are common across tropical rainforests. Despite the humid climate, epiphytes tend to grow in dry and nutrient-poor conditions; they therefore have a number of adaptations to help them survive (left: carnivorous pitcher plant; middle-left: water collection in bromeliad rosettes; middle-right: leafcutter ant. The virtual absence of climatic selection factors reinforce the importance of biotic interactions. Many plants therefore have developed high toxicity defences (right: poison dart frog)



Due to the strong competition for light, trees grow tall. Buttress roots (left) are crucial for rainforest trees to maintain stability. Other species, such as epiphytes, use other trees as a climbing aid. Salt-tolerant mangroves grow in coastal rainforest areas



Lakes

■ The basic distinction between two different types of aquatic biomes is whether they are marine or freshwater. Only 2.6% of Earth's water is fresh water, the bulk of it bound within ice and snow in the polar ice caps and glaciers. Only 0.3% of the Earth's water runs within lakes and rivers.

Fresh water is characterised by the very low salinity of the water, running between groundwater or underground (closed) waters and the open waters at the surface. Surface waters are further distinguished into standing waterbodies and watercourses. The physical and chemical conditions of inland waters can be very different depending on regional conditions. They can vary in acidity from pH 2–12 and in salinity from salt-poor to brackish to the hypersaline lakes of the Dead Sea. Fresh waters can also vary in their trophic character, from ultra-oligotrophic to hypertrophic. In estuaries, fresh water is mixed with marine water along a salinity

■ Most lakes undergo at least a sporadic mixing of water layers. This circulation is normally driven by the wind. However, full circulation is prevented by the stable stratification of water layers according to their density. These density differences stem from variations in temperature or salinity between layers. Since water at 4°C has the highest density, deep water layers usually have temperatures around 4°C, at least in temperate zone lakes. Circulation starts taking place when surface waters reach this temperature and, thus, the same density as deeper waters.

No circulation takes place in amictic lakes, for example in Antarctic lakes covered by permanent ice sheets, or in stably stratified, salt-rich deep-water lakes.

Monomictic lakes are characterised by seasonal circulation periods and can be found either in subpolar areas, where

gradient. In wetlands, swamps and bogs blur the boundary between terrestrial and aquatic habitats.

Trophy is commonly used to assess ecological water quality in standing water, whereas flowing water waterbodies are often defined by their level of saprobity. Trophy refers to the intensity of photoautotrophic primary production. Since it is only possible to measure primary production indirectly in the field, trophy is commonly measured by the concentration of nutrients (usually of phosphates, since phosphate is the limiting nutrient in many freshwater bodies) or of chlorophyll (as an indirect measure of algal biomass and therefore of photoautotrophic organisms). In contrast, saprobity denotes the intensity of the oxygen-consuming process. It is possible to estimate the biological or chemical demand for oxygen. Thus systems exist for measuring organismal communities by both their trophic and saprobic characteristics.

the surface temperature rises to 4°C in the summer months and allows for circulation, or in warm temperate to subtropical areas, where the surface water cools down to 4°C during the winter months.

Dimictic lakes circulate twice per year, usually in spring and autumn, and experience warmer surface temperatures in summer and colder temperatures in winter.

Oligomictic, characterised by a few irregular circulations, and polymictic conditions, with many irregular circulations, are found mainly in large, shallow, and wind-exposed lakes. In these lakes, high wind conditions may interrupt what is otherwise a more stable stratification.

In meromictic lakes, only the upper layers of the waterbody circulate, whereas lower levels, which are dense and mostly anoxic, remain at the bottom.

decomposers: organisms that live on dead or decaying organisms and which are involved in the process of decomposition

phytoplakton: (Grk.: *phyton* = plant, *planktos* = drifting) photoautotrophic organisms which float in water (plankton)

■ **See also:** Photo pigments and vertical ecological niches: 4.4.2

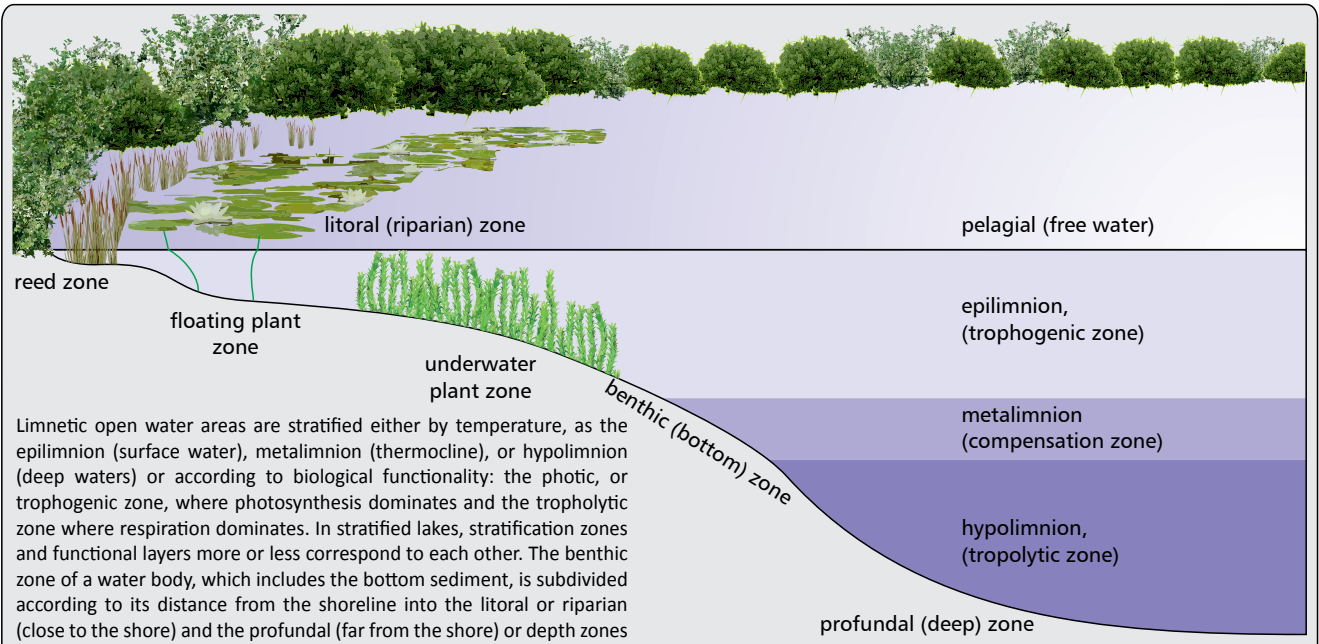
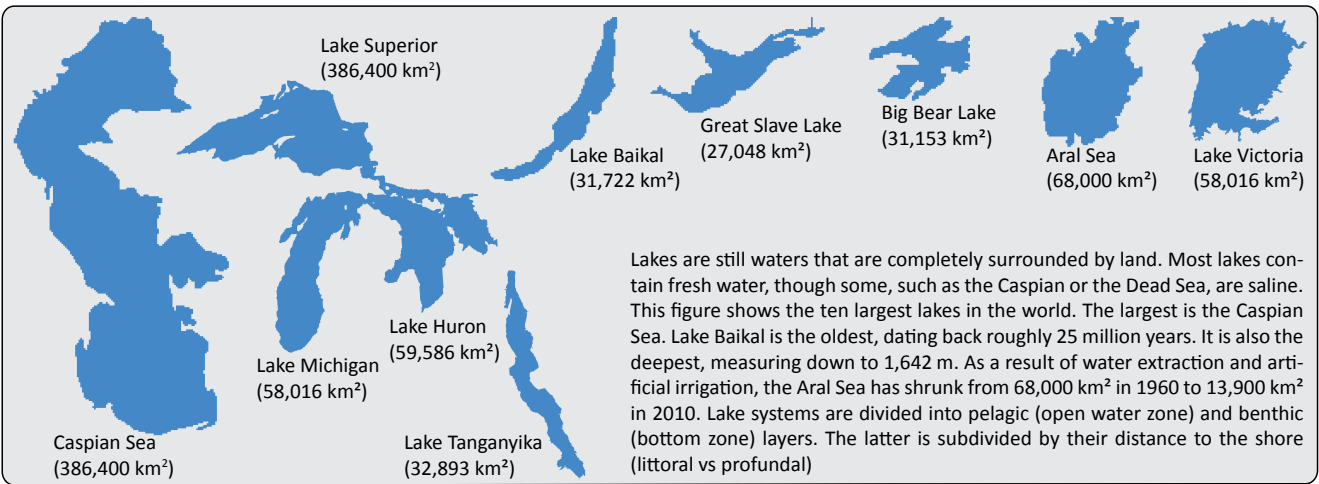

Still waters comprise puddles (short-term), basins (regularly desiccating water), and lakes (large permanent waters). In terms of ecological structure, lakes can be distinguished between littoral (left: near the shore), pelagic (centre: open water), and benthic (right: near the bottom). In addition, a distinction is made between the light-filled trophogenic zone, where photosynthesis and thus primary production takes place, and the low-light tropholytic zone, where oxygen-consuming processes take place. The boundary between the trophogenic and tropholytic zones is known as the compensation depth. Trophic is often used to ecologically classify lakes. It refers to the primary production potential of a lake. In oligotrophic lakes, primary production potential is low, mostly because nutrient concentrations are low. In contrast, in eutrophic lakes, primary production is high, and these lakes are therefore characterised by higher nutrient concentrations



Rivers

Watercourses can be divided, according to their size, into creeks, small, and large rivers. Furthermore, watercourses can be divided into stream types, including by region-specific characteristics, such as ecoregion, altitude, and geology. Longitudinally, watercourses can be divided by the upper, middle overflows, the underflow, and the estuary. The divisions have ecological importance, since upstream processes affect downstream waters whereas the opposite cannot take place. The food chain within a watercourse also strongly de-

Watercourses may represent a complex array of habitats, including both the body of water itself and the riverbed, as well as the terrestrial environment around the waterbody. This habitat is heavily influenced by the flow of water nearby, in particular on floodplains, where still and flowing waters are separated from each other.

There are many systems of classification of river zones based on their condition. For example, a system of zonation used primarily in francophone and German communities divides rivers into three primary zones: the crenon, rhithron, and potamon.

The crenon is strongly influenced by groundwater and therefore experiences only gradual temperature fluctuations. With the exception of source regions in heavily agricultural regions, where rates of nitrate are often high, nutrient content in the crenon is generally low. Also, as a result of the strong influence of groundwater, crenon zone waters are of-

pend on the entry of organic material at its upper reaches, creating a gradual series of changing interactions from the source to the mouth of each river. This is known as the river continuum concept.

The saprobic quality is used to assess the ecological quality of running waters. Saprobity describes the intensity of oxygen-consuming processes, which can be estimated based on the chemical or the biological oxygen demand.

ten low in oxygen. Flow conditions are highly variable, but on average, levels of erosion are stronger than sedimentation.

The rhithron is characterised by higher flow rates than crenon and potamon zones. Erosion rates are therefore high and the riverbed is commonly composed of gravel and stones. Due to the narrow width of rhithron waters, these are strongly influenced by the surrounding vegetation and therefore also usually heavily shaded; as a result, higher aquatic plants and phytoplankton play a minimal role in the rhithral ecosystem. Rhithron waters are often oxygen-rich as a result of lower temperatures due to shading and the strong mixing due to heavy flow.

In the potamon, the water flow is low and waters are exposed to higher levels of sunlight due to the generally wider waterbody. As a result of the increased light levels, aquatic plants tend to populate potamal zones more densely, and phytoplankton is more abundant. The potamon riverbed is fine-grained due to the generally lower flow rates.

estuary: (Lat.: *aestuarium* = bay) broad body of water where a river flows into the sea

saprobity: collective term given to all digestive processes of dead organic matter

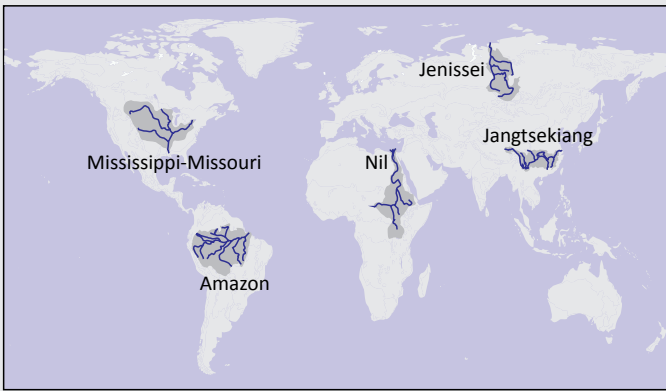

The five longest rivers in the world and their catchment areas:

1) The Nile is 6,852 km long and has a catchment area of 3,255,000 km². The average water flow in the middle of the Nile reaches 2,770 m³/s at its peak and up to 1,250 m³/s at its mouth. Due to the extraction of water for irrigation, the actual water flow at the mouth is reduced to 140 m³/s

2) The Amazon is 6,448 km long and has a catchment area of 5,956,000 km², with an average flow of 206,000 m³/s. The Amazon is the most water-rich river in the world

3) The Yangtze River is 6,380 km long with a catchment area of 1,722,155 km². Its average flow rate is 31,900 m³/s

4) The Mississippi River is 3,778 km long and has a catchment area of 2,981,076 km² with an average flow rate of 18,400 m³/s. Its longest tributary, the Missouri, is 4,130 km long and has a catchment area of 1,371,010 km²

5) The Yenisei River is 4,092 km long and has a catchment area of 2,580,000 km², with an average flow rate of 18,395 m³/s

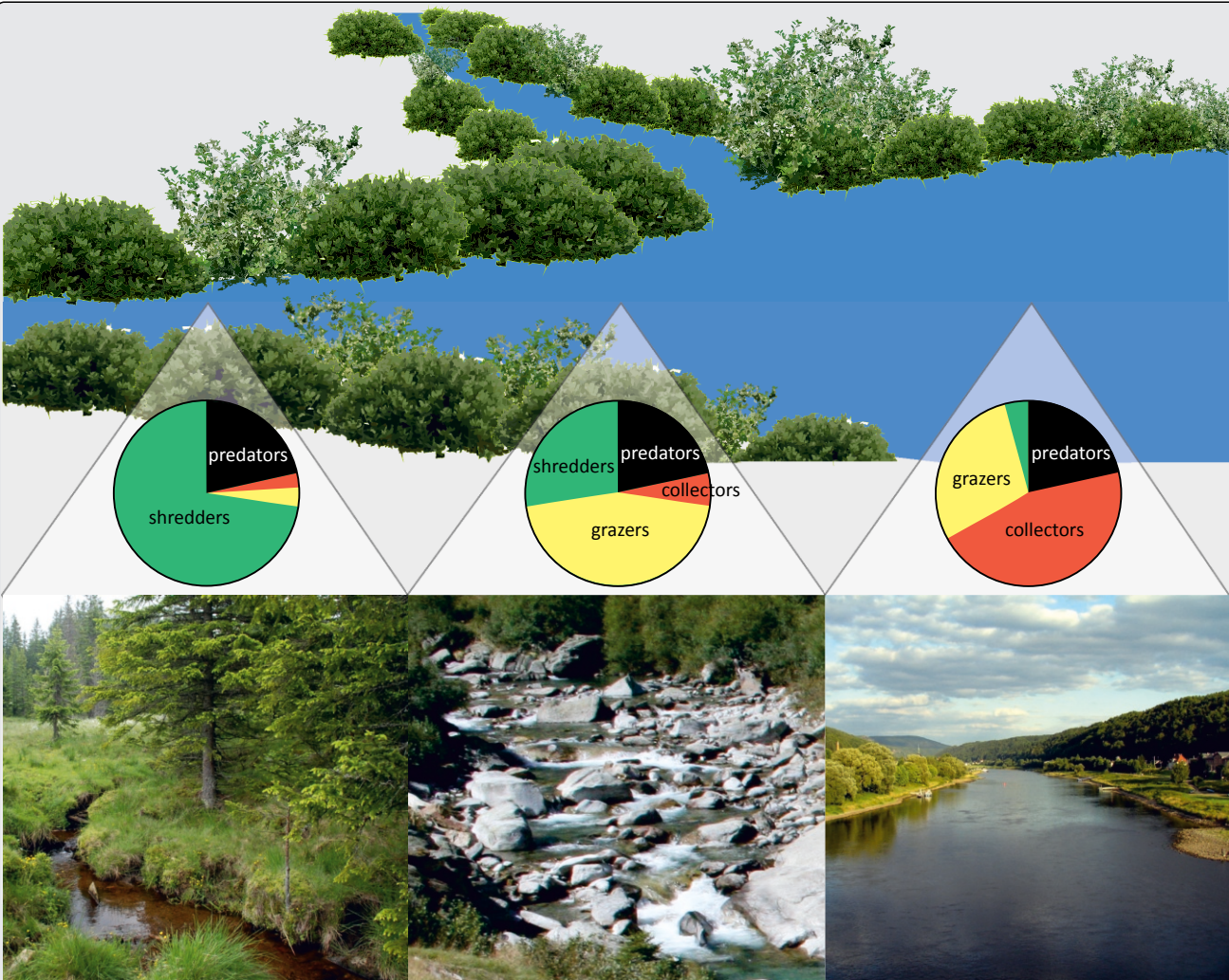

In limnology, rivers are classified as being either crenon (left: source region), rhithron (centre: creek region) or potamon (right: river region). The properties of flowing water, and in particular the availability and quality of organic matter, change as it moves from the source to the mouth of the river. In the upper reaches of a river source (allochthonous), respiration rates are higher than production; these areas are dominated by organisms that are able to shred the coarse plant material. In the middle reaches of a river, the supply of allochthonous materials decreases and, therefore, respiration rates are lower than production rates. These habitats are dominated by grazers, feeding on algae, and the proportion of shredders decreases. In the lower reaches of the river, the rate of suspended solids increases, limiting photosynthesis and increasing relative rates of respiration. Communities near the mouth of rivers are dominated by collectors whereas the proportion of predators stays the same. These fluctuations along the watercourse are known as the River Continuum Concept



Oceans and seas

■ Oceans cover around 71% of the Earth's surface, occupying a water volume of 1.34 billion km³. Only the upper euphotic zone of the ocean, down to around 200 m in depth, gets enough light for photosynthesis to occur, while deeper, aphotic layers do not permit any photosynthesis. Coastal areas, which are up to 200 m in depth, in other words where photosynthesis can occur throughout the waterbody, are known as continental shelves. Continental shelves are linked to the deeper ocean by a sloping sea slope (continental slope) with depths down to 2,000–3,000 m, followed by the abyssal (up to around 6,000 m) and hadal zones (6,000 m and beyond).

Seawater has a salinity of 3.5%, though this may decrease in some areas and regions. For example, the Mediterranean has a salt concentration of 3.6–3.9%, compared with the Baltic Sea which ranges from 0.3–1.7%. However, the rela-

■ Water depth is a vital factor in the distribution of life, in particular because of changes in carbonate solubility as a result of depth. In deeper water layers photosynthesis does not take place due to the lack of light, whereas oxygen-consuming processes do, by way of through respiration of heterotrophic organisms. In consequence, oxygen concentration decreases with depth whereas carbon dioxide concentration increases. The forming of carbon dioxide and carbonic acid water leads to an increasing solution of carbonates. For aragonite (calcium carbonate), the compensation depth is 3,000–5,000 m. For the most stable calcite (also calcium carbonate), it is 3,500–5,500 m. Below this depth, therefore, carbonates cannot be deposited. Deep-sea sediments consist mostly of silicates.

tive composition of sea salt remains almost the same in all saline waterbodies due to the high levels of mixing in the ocean. Sea salt is made up of 55% chloride (1.9 g/L), 30.5% sodium (1.07 g/L), 7.7% sulfate (0.27 g/L), 3.7% magnesium (0.13 g/L), 1.2% calcium (0.04 g/L), 1.1% potassium (0.04 g/L), and 0.8% of other ions. Salt lakes, such as the Dead and Caspian seas, in contrast, have widely different salt compositions. As a result of the salt content, the freezing point of seawater is -1.9°C .

Despite their relatively low biomass, oceans are vital for the global flow of nutrients because of their large surface area. About half of global primary production stems from the ocean, mainly through diatoms (Bacillariophyta) and dinoflagellates.

Large areas of the open ocean are ultraoligotrophic but some areas have comparatively high concentrations of the main nutrients (phosphate, nitrate). However, algal growth in these areas remains low. The so-called HNLC (high-nutrient low-chlorophyll) regions are mainly upwelling areas with rising nutrient-rich deep waters, in particular at the circumpolar oceans around Antarctica. Algal growth in these areas is limited as a result of low concentrations of micronutrients. In the context of climate change, the nutrient-rich upwellings of the Southern Ocean are of great interest to the scientific community, since they are vital for stimulating primary production in the ocean and therefore enabling carbon fixation.

aphotic zone: the deep water layers which sunlight fails to penetrate

circumpolar: surrounding one of the Earth's poles

euphotic zone: the uppermost layer of water, the sunlight zone

■ **See also:** Biomineralisation: 4.5.2, 4.5.2.1; Bacillariophyceae: 4.6.2.4; Dinophyta: 4.6.1.2; Light availability: 4.4.2; Carbonate balance 2.1.2.3

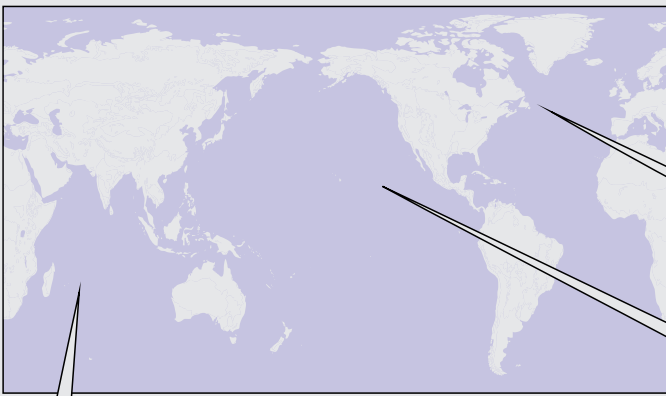

Oceans cover around 71 % of the Earth's surface. The Arctic and Antarctic are, depending on the point of view, considered as separate oceans from the Pacific, Atlantic, and Indian oceans. Since photosynthesis only takes place in the upper layers of the oceans, oxygen saturation decreases with depth

The Indian Ocean covers an area of 75 million km² and has a volume of 292 million km³. The mean depth is 3,936 m, with its deepest point at Diamond Deep (8,047 m)

The Atlantic Ocean covers an area of around 80 million km² and has a volume of 355 million km³. Its mean depth is 3,293 m, with the deepest point being the Milwaukee Deep (9,219 m)

The Pacific Ocean covers an area of 181 million km² and has a volume of 714 million km³, containing over half of the Earth's water. Its mean depth is 3,940 m, the lowest point being at the Witjas Deep within the Mariana Trench (11,034 m)



The organisms living in the surf zone endure high mechanical loads due to wave action and sporadic periods of drought. Continental shelf areas are generally richer in nutrients than the open ocean. In shallower sea areas light can penetrate to the bottom



The open ocean is ultraoligotrophic, extremely nutrient-poor. Currents are vital for the global flow of nutrients to the large area that they occupy. Significant primary producers are diatoms and dinoflagellates

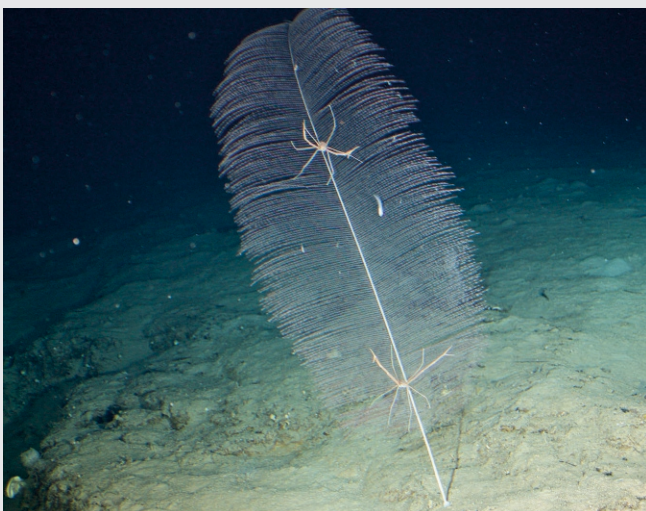

Photosynthesis is impossible below the photic zone, so food webs rely on the upper water layers (here: *Bathypathes* sp. – black coral with deep-sea crabs)



Coral reefs are extremely diverse marine ecosystems. The biomineralisation of reef-building organisms is geologically important for the rock-forming process