

Review

Proteins under pressure

The influence of high hydrostatic pressure on structure, function and assembly of proteins and protein complexes

Michael GROSS and Rainer JAENICKE

Institut für Biophysik und physikalische Biochemie, Universität Regensburg, Germany

(Received November 9, 1993) – EJB 93 1674/0

Oceans not only cover the major part of the earth's surface but also reach into depths exceeding the height of the Mt Everest. They are populated down to the deepest levels ($\approx 11\,800$ m), which means that a significant proportion of the global biosphere is exposed to pressures of up to 120 MPa. Although this fact has been known for more than a century, the ecology of the 'abyss' is still in its infancy. Only recently, barophilic adaptation, i.e. the requirement of elevated pressure for viability, has been firmly established. In non-adapted organisms, increased pressure leads to morphological anomalies or growth inhibition, and ultimately to cell death. The detailed molecular mechanism of the underlying 'metabolic dislocation' is unresolved.

Effects of pressure as a variable in microbiology, biochemistry and biotechnology allow the structure/function relationship of proteins and protein conjugates to be analyzed. In this context, stabilization by cofactors or accessory proteins has been observed. High-pressure equipment available today allows the comprehensive characterization of the behaviour of proteins under pressure. Single-chain proteins undergo pressure-induced denaturation in the 100-MPa range, which, in the case of oligomeric proteins or protein assemblies, is preceded by dissociation at lower pressure. The effects may be ascribed to the positive reaction volumes connected with the formation of hydrophobic and ionic interactions. In addition, the possibility of conformational effects exerted by moderate, non-denaturing pressures, and related to the intrinsic compressibility of proteins, is discussed. Crystallization may serve as a model reaction of protein self-organization. Kinetic aspects of its pressure-induced inhibition can be described by a model based on the Oosawa theory of molecular association. Barosensitivity is known to be correlated with the pressure-induced inhibition of protein biosynthesis. Attempts to track down the ultimate cause in the dissociation of ribosomes have revealed remarkable stabilization of functional complexes under pseudo-physiological conditions, with the post-translational complex as the most pressure-sensitive species. Apart from the key issue of barosensitivity and barophilic adaptation, high-pressure biochemistry may provide means to develop new approaches to nonthermic industrial processes, especially in the field of food technology.

Life in the deep sea faces a whole set of unfavourable conditions, including pressures up to 120 MPa (1200 bar), temperatures around 2°C or, in volcanic regions, above 100°C, absence of sunlight, and scarce supply of organic nutrients. When 'deep' means deeper than 1000 m, these biotopes include more than half ($\approx 62\%$) of the volume of the global biosphere (Jannasch and Taylor, 1984). The average pressure on the ocean floor is of the order of 38 MPa, indicat-

ing that atmospheric pressure is far from being the normal case for aquatic organisms. However, studies of life under deep-sea conditions have advanced slowly since the fundamental work of Certes (1884a,b), who established the existence of microorganisms in deep sea sediments. For a long time, technical difficulties in obtaining and handling samples of deep-sea organisms have been an obstacle in the development of high-pressure biology. Only with the work of ZoBell and Johnson (1949) had the time for systematic studies in this area come. Slow but continuing progress has been documented in several monographs (Zimmerman, 1970; Sleight and Macdonald, 1972; Marquis, 1982; Smith, 1984; Jannasch et al., 1987). In 1977, the unexpected discovery of flourishing biotopes with high population densities of invertebrates at deep-sea hydrothermal vents added a completely new aspect to deep-sea biology. Obviously, hydrothermal-vent communities are virtually independent of organic materials sedimenting from surface biotopes. Nutrients are pro-

Correspondence to R. Jaenicke, Institut für Biophysik und physikalische Biochemie, Universität Regensburg, D-93040 Regensburg, Germany

Fax: +49 941 943 2813.

Abbreviations. N, D, M, and M* native, denatured, monomeric, and unfolded monomeric states; p_c , critical pressure; t_c , critical temperature; TMV tobacco mosaic virus; u , velocity of sound; ΔV and ΔV^* , reaction and activation volumes; β_s , adiabatic compressibility.

Note. This review is dedicated to Professor Alfred Schellenberger on the occasion of his 65th birthday.

vided by chemosynthetic bacteria, which live on the oxidation of H_2S , H_2 and other reduced inorganic compounds (Jannasch and Taylor, 1984; Jannasch, 1985, 1987).

High-pressure biochemistry began to emerge in the 1960s and 70s and focused on the effects of pressure on proteins, nucleoproteins, and membranes (Jaenicke, 1981; Morild, 1981; Heremans, 1982; Weber and Drickamer, 1983; Macdonald, 1984; Balny et al., 1989). The description of its development, especially in the past years, will be the central topic of this review; for earlier work, see Jaenicke (1981, 1987). For the first time in a review on high-pressure biochemistry, special emphasis will be placed on dynamic compressibility of proteins as compared to static pressure effects.

Biotechnologists began exploring high-pressure processes only recently. Pioneering work, especially connected with food science, was performed mainly in Japan (Hayashi, 1989). In 1992, a joint conference of European high-pressure groups and Japanese researchers active in high-pressure food technology documented the growing interest in industrial applications of high-pressure biochemistry (Balny et al., 1992). A section at the end of this review will provide an outlook on developments to be expected in the near future.

Effects of pressure on (unicellular) organisms

Non-adapted (mesophilic) microorganisms commonly show growth inhibition at about 40–50 MPa. The cessation of growth is accompanied by morphological changes such as formation of filaments in *Escherichia coli* (ZoBell, 1970) and cell chains or pseudomycelia in the marine yeast *Rhodospiridium sphaerocarpum* (Lorenz and Molitoris, 1992a; Lorenz, 1993). Much higher pressures (in the range of 100 MPa) are needed for sterilization purposes (Sonoike et al., 1992; Takahashi, 1992). The survival of *Saccharomyces cerevisiae* at these pressures has been shown to be enhanced by preceding heat-shock treatment (Iwahashi et al., 1991). The number of colony-forming units after a 1-h incubation at 150 MPa was increased 100-fold, if a pre-incubation of 30 min at 40–43°C was applied. Survival of high pressure and of high-temperature stress depended in much the same way on the conditions of this treatment. Microorganisms sampled from depths of more than 3500 m tend to be barophilic, i.e. they require high pressure for regular growth and reproduction (Yayanos, 1986; Yayanos and Delong, 1987). From our present knowledge about the physical conditions in high-pressure biotopes, it is evident that, for example in the abyss or in hydrothermal vents, adaptation to low or high temperatures represents an additional adaptive challenge. This means that evolution had (and still has) to cope with complex superpositions of parameters rendering it most difficult to separate and specifically define strategies of molecular adaptation for barophilic, psychrophilic, thermophilic and other 'extremophilic' organisms. It is the intricate interplay of parameters which explains the observation that, given the presumed temperature of the natural habitat, optimum growth at pressures beyond 0.1 MPa is not only found in deep-sea organisms. Terrestrial and shallow-water microorganisms such as the methanogenic archaeon *Methanococcus thermolithotrophicus* have been shown to respond positively to moderate hydrostatic pressures (Bernhardt et al., 1988b). One reason may simply be attributed to Henry-Dalton's law, i.e. increased solubility of gaseous substrates (H_2 , CO_2) at elevated pressure. In addition, the induction of 'pressure-shock proteins' has been demonstrated by two-dimensional polyacrylamide gel electrophoresis (Jaenicke et al., 1988), as

well as on the mRNA level (Bartlett et al., 1989). Attempts to generalize these findings have been made by screening representative examples of all three kingdoms (M. Groß, I. J. Kosmowsky, R. Lorenz, H.-P. Molitoris & R. Jaenicke, unpublished work). Detailed studies on the pressure response of anaerobically grown *E. coli* K12 have been reported by Welch et al. (1993). Analysis of protein induction, following an abrupt pressure shift from atmospheric pressure to 55 MPa revealed the occurrence of a set of more than 50 'pressure-induced proteins' whose rate of synthesis in relation to the total protein synthesis is found to be increased. Thus, this group may include proteins the synthesis of which is actually inhibited by the pressure shift less markedly than the average. Some of the pressure-induced proteins are well known heat- or cold-shock proteins (including GroEL, GroES and DnaK), whereas others have not been observed previously. The latter is also true for the predominant pressure-induced protein, a 115.6-kDa protein with an isoelectric point of 11.0. Concerning the mechanism of pressure-induced protein biosynthesis, the fact that both heat- and cold-shock proteins are involved suggests that ribosomes may play a role in sensing the stress signal, as was claimed previously for heat and cold shock (van Bogelen and Neidhardt, 1990).

The occurrence of obligate barophilic microorganisms (not able to grow at atmospheric pressure) has been disputed for some time (for review, see Jaenicke, 1981) but is firmly established by now (Yayanos and Delong, 1987; Deming et al., 1988). However, mechanisms of pressure sensitivity on one side, and adaptation on the other, still await elucidation. Basic concepts of the physiology have been developed (Somero, 1992). Studies on biological macromolecules and model systems, which are the main topic of this review, will be outlined in detail, following a brief introduction into the underlying physico-chemical concepts and a description of the experimental methodology.

Effects of pressure on chemical reactions and weak interactions

Chemical equilibria respond to pressure in a way defined by the size and sign of their reaction volumes:

$$\left(\frac{\partial \ln K}{\partial p}\right)_T = -\frac{\Delta V}{RT} \quad (1)$$

where K is the equilibrium constant, p the pressure, T the absolute temperature, R the gas constant and ΔV the difference of the final and initial volumes of the reactants.

In formal analogy, the dependence of the rate constant k on the pressure, which can be derived from the Eyring theory, can be written:

$$\left(\frac{\partial \ln k}{\partial p}\right)_T = -\frac{\Delta V^\ddagger}{RT} \quad (2)$$

where ΔV^\ddagger is the activation volume. Thus, any equilibrium connected with a non-zero volume change will be shifted toward the more compact state by the application of hydrostatic pressure; and any reaction connected with a positive (negative) activation volume will be slowed down (accelerated) by pressure.

Equilibrium thermodynamics determining the structure and stability of biological macromolecules depend mainly on three kinds of interactions: ionic, hydrophobic and hydrogen bonding. Ion pairs in aqueous solution are strongly destabi-

Table 1. Reaction volumes associated with selected biochemically important reactions (25°C). For further data, including activation volumes of inorganic and organic reactions, cf. van Eldik et al. (1989).

Reaction	Example	ΔV
		ml/mol
Protonation/ion-pair formation	$H^+ + OH^- \rightarrow H_2O$	+ 21.3
	imidazole + $H^+ \rightarrow$ imidazole $\cdot H^+$	- 1.1
	Tris + $H^+ \rightarrow$ Tris $\cdot H^+$	- 1.1
	$HPO_4^{2-} + H^+ \rightarrow H_2PO_4^-$	+ 24.0
	$CO_3^{2-} + 2H^+ \rightarrow HCO_3^- + H^+ \rightarrow H_2CO_3$	+ 25.5 ^a
	protein-COO ⁻ + $H^+ \rightarrow$ protein-COOH	+ 10
	protein-NH ₃ ⁺ + $OH^- \rightarrow$ protein-NH ₂ + H ₂ O	+ 20
Hydrogen-bond formation	poly(L-lysine) (helix formation)	- 1.0
	poly(A+U) (helix formation)	+ 1.0 ^b
Hydrophobic hydration	$C_6H_6 \rightarrow (C_6H_6)_{water}$	- 6.2
	$(CH_4)_{hexane} \rightarrow (CH_4)_{water}$	- 22.7
Hydration of polar groups	<i>n</i> -propanol \rightarrow (<i>n</i> -propanol) _{water}	- 4.5
Protein dissociation/association	lactate dehydrogenase (M ₄ \rightarrow 4M) apoenzyme	-500
	holoenzyme (saturated with NADH)	-390
	microtubule formation (tubulin propagation; ΔV per subunit	+ 90
	ribosome association (<i>E. coli</i> 70S)	$\geq 200^c$
Protein denaturation	myoglobin (pH 5, 20°C)	- 98

^a ΔV for each ionization step.

^b For DNA denaturation: 0–3 ml/mol base pair.

^c 200–850 ml/mol, depending on pressure and state of charging.

lized by hydrostatic pressure. This effect is attributed to the electrostrictive effect of the separated charges: each of it arranges water molecules in its vicinity more densely than bulk water. Thus the overall volume change favours the dissociation of ionic interactions under pressure. For the same reason the pH of water is shifted by 0.3 when pressure is raised from 0.1 to 100 MPa; in certain buffer systems the effect is even larger (for buffer systems with low pressure coefficients, cf. Bernhardt et al., 1988a; Distèche, 1972).

Similarly, the exposure of hydrophobic groups to water disturbs the 'loosely packed' structure of pure water and leads to a hydrophobic solvation layer which is assumed to be more densely packed (Kauzmann, 1959; J. Finney, unpublished). Hence, the exposure of hydrophobic residues occurring, for instance, during the unfolding of proteins is favoured at elevated pressure. In this context, the well established fact that van der Waals' forces contribute significantly to hydrophobic interactions (Privalov, 1993) should be kept in mind. Since they tend to maximize packing density, one would predict their pressure coefficient to be positive.

Formation of hydrogen bonds in biomacromolecules is connected to a negligibly small reaction volume, which may be positive or negative, depending on the model system. Table 1 gives some typical values for the volume effects connected with biochemical reactions involving the various interactions. From the previous discussion of the size and sign of ΔV and ΔV^* , it is obvious that water as the main component of the cell and as a standard solvent in biochemistry plays a major role in our understanding of high-pressure effects. It needs hardly to be mentioned that water is far from being a simple liquid (Franks, 1972–90; Lang and Lüdemann, 1982, 1990; Lüdemann, 1992). Its structure is still puzzling physicists and physicochemists and its anomalies provide pitfalls as well as unexpected chances when hydrostatic pressure is applied to biological reactions in their natural aqueous environment.

Experimental facilities and methods

The 'classical' high-pressure techniques include ultraviolet/visible spectroscopy, fluorimetry, stopped-flow kinetics and tube gel electrophoresis at elevated pressures (Hawley, 1978; Schade et al., 1980b; Heremans, 1982; Cléry and Mason, 1992) (Fig. 1A–C). More recently, high-pressure NMR has become feasible, including two-dimensional NMR at hydrostatic pressures up to 500 MPa (Jonas, 1992). X-ray crystallography under pressure has been used for lysozyme (Kundrot and Richards, 1987, 1988) which, however, remained the only system studied by this technique. Similarly, the application of circular dichroic spectroscopy under pressure has been described, but very rarely used (Harris et al., 1976).

An astonishing example of how many different manipulations can be performed on a pressurized sample is provided by the high-pressure patch-clamp recording technique (Fig. 1D). The sample can be illuminated, watched, moved in three dimensions, and highly sensitive electrical equipment for patch-clamp recording is provided in the autoclave. Another high-pressure marvel is the 'portable spectroscopy unit' reported by Spitzer et al. (1988).

Highly specialized equipment has also been developed for the isolation (Dietz and Yayanos, 1978) and growth of micro-organisms under pressure, e.g. for methanogens (Bernhardt et al., 1987), for marine fungi (Lorenz and Molitoris, 1992b) and for high-pressure cultivation in temperature gradients (Yayanos et al., 1984).

Thus there is no restriction as to what one can in principle do with pressurized samples (varying other parameters, hydrogen exchange, hybridization, electrophoresis, etc). Of course, sample handling must be economized in order to avoid the need of excessively complicated high-pressure equipment.

Furthermore, in certain experimental techniques such as ultracentrifugation (Harrington and Kegeles, 1973), HPLC,

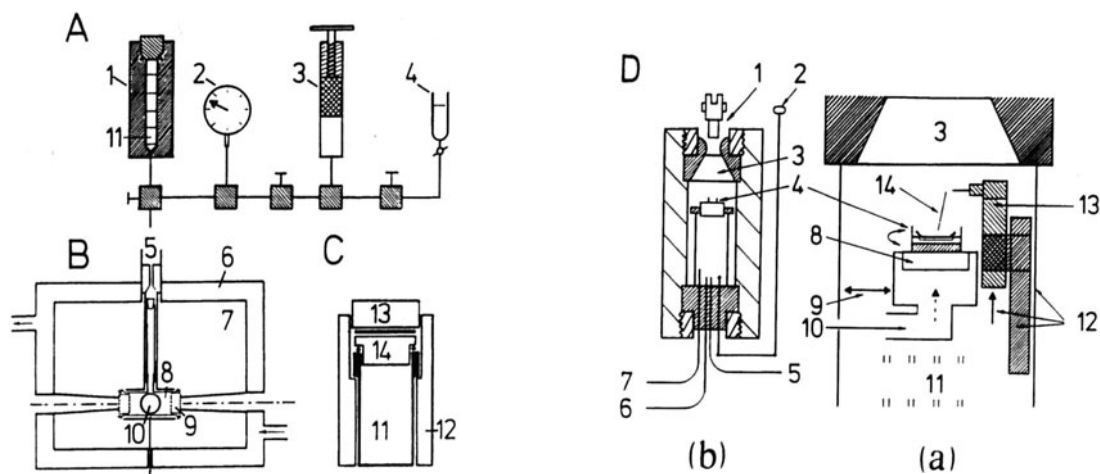

Fig. 1. High-pressure equipment (A) Schematic representation of high-pressure apparatus: 1, autoclave; 2, Bourdon gauge; 3, hydraulic pump; 4, reservoir for hydraulic fluid. (B) High-pressure transmission and fluorescence cuvette: 5, pressure inlet; 6, thermostating jacket with thermocouple; 7, Cu-Be or stainless steel block; 8, teflon sample cell (volume 2 ml) with silicon hose and stopper; 9, sapphire windows; 10, ultraviolet light guide to monitor fluorescence emission (at right angles to the transmission beam (---)). (C) Flexible teflon container (11) (volume \approx 2 ml for autoclave 1 in A): 12, copper cylinder; 13, screw with steel plate; 14, teflon stopper with rubber O-ring. (D) Patch-clamp recording equipment at helium pressures up to 50 MPa. The patch-clamp recording equipment (a) can be accommodated in a pressure vessel with 15-cm bore (b). The pressurized sample can be moved, illuminated, manipulated with the patch electrode and watched with a long-range binocular microscope: 1, microscope; 2, drive control; 3, window; 4, tissue bath on movable platform; 5, electrical connection; 6, gas connection; 7, light guide; 8, rotating platform; 9, x and y movement; 10, light guide and prism; 11, mechanical linkage to external drives; 12, micrometer vertical drive; 13, pre-amp pressure casing; 14, patch electrode (Macdonald et al., 1989).

etc., high pressure occurs as an intrinsic effect, which must be taken into account in interpreting data, especially on dissociable or compressible systems. On the other hand, these techniques can also be used to create pressures at will; for instance, in common swing-out rotors in the ultracentrifuge, pressure gradients from 0.1 to 140 MPa can easily be accomplished (Seifert et al., 1984).

Effects of pressure on proteins and protein complexes

The delicate balance of stabilizing and destabilizing interactions makes proteins exhibit only marginal intrinsic stability. Considering the fundamental principles of the structure of globular proteins, i.e. optimum packing of the hydrophobic core, minimum hydrophobic surface area, and ion pairs within and between subunits (Perutz and Raidt, 1975; Richards, 1977; Dill, 1990; Jaenicke, 1991a,b), it is evident that high hydrostatic pressure must be effective at the levels of both the tertiary and quaternary structures. Since there is no way to differentiate between specific and unspecific interactions, pressure will promote the dissociation of oligomeric proteins and assembly systems of higher complexity on the one hand, and unfolding and misassembly on the other (Jaenicke, 1987).

Monomeric proteins

Denaturation and refolding

Pressure-induced denaturation of a monomeric protein was first observed by Bridgman (1914), but systematic studies of the effect only began half a century later. The first reversible denaturation/renaturation by pressure was described by Suzuki et al. (1963). Quantitative evaluation of the thermodynamics of pressure-induced denaturation became feasible with the introduction of ultraviolet spectroscopy at pressures of 10^8 Pa. Studies of Brandts et al. (1970)

on RNase A, of Hawley (1971) on chymotrypsinogen and of Zipp and Kauzmann (1973) on metmyoglobin provided sufficient data for p/T diagrams which revealed elliptic contours indicating that proteins can show heat and cold denaturation (Fig. 2). A decrease of the limiting pressure of denaturation at low temperature had already been observed by Bridgman (1914).

In general, single-chain proteins, studied at ambient temperature and neutral pH, do not undergo denaturation at pressures below 400 MPa. This indicates that protein denaturation cannot play a significant role as a stress phenomenon in the adaptation of microorganisms toward deep-sea conditions. Application of a two-state model for the $N \rightleftharpoons D$ equilibrium transition yields reaction volumes between 30–100 ml/mol. The validity of two-state approximations for the pressure-induced unfolding of monomeric proteins was first challenged by Li et al. (1976). In this study, the protein fluorescence of lysozyme was shown to exhibit two separate transitions, a smooth one between 200–800 MPa, and a highly cooperative one between 800–1100 MPa, both accounting for approximately the same amplitude in fluorescence change (Fig. 3). Binding of a substrate analogue made both transitions coincide. A more detailed account was provided by the application of high-resolution NMR techniques under pressure. First results in the pressure range up to 500 MPa corroborated the biphasic transition (Samarasinghe et al., 1992; Jonas, 1992). The corresponding reaction volumes obtained from the pressure-dependent proton NMR signals of five amino acid residues located in different regions of the molecule were found to differ significantly. Three residues located in the α -helical domain (Trp28, Leu17, His15) yielded reaction volumes around 10.5 ml/mol, whereas the reaction volume for Cys64, located in the β -sheet domain, was only 9.3 ml/mol. In accord with these volume changes, the β -domain was found to be more stable against pressure-induced unfolding than the α -domain. As in the earlier study (Li et al. 1976), the difference vanished upon binding of a

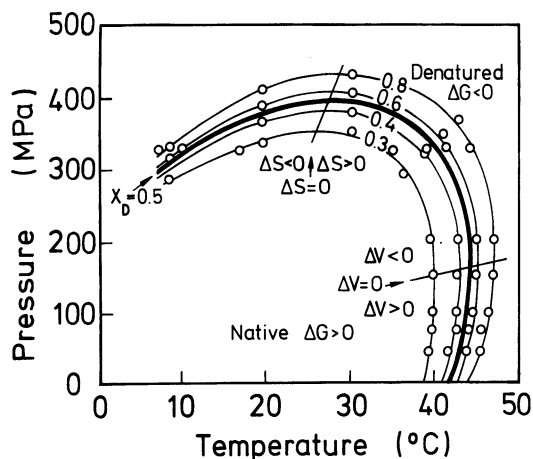

Fig. 2. Pressure/temperature map for the stability of chymotrypsinogen A (pH 2). The contour lines connect points with equal molar fraction of denatured protein (X_D), corresponding to equal Gibbs free energy of denaturation. The thick line ($\Delta G = 0$, $X_D = 0.5$) represents the midpoints of the transitions under various conditions. From bottom right to top left, three different kinds of transition can be distinguished and explained in terms of the fundamental equation $\Delta G = \Delta V dp - \Delta S dT$. At high temperatures and low pressures, both ΔV and ΔS are positive, implying a positive slope for the contour lines. Increase of temperature or decrease of pressure may lead to denaturation under these conditions. At the pressure of maximum transition temperature, the sign of ΔV is reversed. From this point onward, denaturation at higher temperatures needs lower pressures; the protein can be denatured by increase in pressure or temperature. Finally, at the pressure of maximum transition temperature, ΔS also becomes negative, leading to the cold denaturation phenomenon. The denaturation pressure decreases with decreasing temperature, allowing cold denaturation at least at elevated pressure. Extrapolation of this curve to sub-zero temperatures led to the suggestion that cold denaturation should occur at atmospheric pressure in supercooled aqueous solutions. (Modified from Hawley, 1971.)

substrate analogue. It is obvious that a more comprehensive study is needed to firmly establish these findings.

The higher stability of the β -domain matches the observation that this domain is essentially incompressible (see below). One should keep in mind that, in refolding experiments following chemical denaturation, the α -domain has been established to refold more rapidly than the β -domain (Radford et al., 1992). As a complete assignment of all the amide protons of lysozyme is available (Redfield and Dobson, 1988), more revelations are to be expected from NMR studies on the pressure-induced unfolding of this protein. In combination with fluorescence techniques and site-directed mutagenesis, NMR has also been used to analyze the pressure-induced unfolding of staphylococcal nuclease (Royer et al., 1993).

In a totally different approach, Davis and Siebenaller (1992) and Dufour et al. (1992) made use of limited proteolysis at varying pressure in order to follow pressure-induced unfolding (and dissociation). This approach, however, suffers from the fact that the proteolytic enzyme itself may be modulated in its activity by high-pressure effects such as compression or pre-denaturation (see below). Thus the interpretation of these results may be ambiguous.

Compressibility: dynamic vs static compression

Considering possible effects of pressures below the limit where denaturation occurs, variations in the space-filling

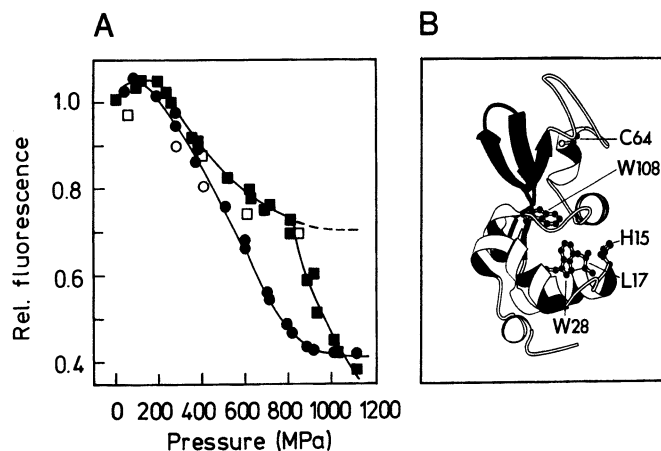

Fig. 3. Pressure-induced denaturation of hen egg-white lysozyme. (A) Relative fluorescence yields as a function of pressure for lysozyme (■) and a lysozyme/tri-*N*-acetylglucosamine complex (●). The two-step mechanism of the free enzyme is suppressed by the substrate analogue (Li et al. 1976). (○, □) Data obtained upon lowering the pressure of the samples. Similar results have been obtained in an NMR study using the five amino acids marked in the ribbon model depicted in B (Samarasinghe et al., 1992). Cys64 (probing the β -domain) showed a smaller ΔV of denaturation than all the other residues. Upon binding a substrate analogue, the behaviour of the cysteine 'probe' became indistinguishable from the α -domain residues, whereas Trp108 (probing the active-site cleft) exhibited a marked increase in ΔV . The view in the model is along the axis of helix C, close to the interface separating the α -domain (at the bottom) from the β -domain (at the top). The picture was created by using the MOLSCRIPT software (Kraulis, 1991).

properties come to mind. Compressibility and structural changes have been studied by crystallography, fluorescence spectroscopy, sound velocimetry and enzyme activity assays. Most of the data available for protein compressibilities come from sound velocimetry measurements. According to

$$\beta_s = 1/\rho u^2 \quad (3)$$

the adiabatic compressibility β_s of a solute is related to both the density ρ of the solution and the sound velocity u (for a detailed discussion, see Sarvazyan, 1991). Systematic studies have revealed that globular proteins usually have positive partial specific compressibilities (Gekko and Hasegawa, 1986, 1989). The numerical values correlate with the partial specific volume (Fig. 4), protease digestability, and (inversely proportional) with the Gibbs free energy of unfolding. Thus, compact proteins with low flexibility show low compressibility and high stability, and vice versa.

However, in this simple and plausible argument, the separation of hydrational and intrinsic contributions to the overall compressibility requires careful consideration. For the differentiation between the two contributions, several variants of 'additive methods' and the 'regression method' are available; they have been compared in detail by Kharakoz and Sarvazyan (1993).

Additive methods calculate the hydrational contribution as the sum of the compressibilities of solvent-exposed groups, which can be estimated from results obtained with small model compounds (Kharakoz, 1991). Another variant of the additive approach emphasizes the role of the water molecules, multiplying the hydration number with the estimated difference between the compressibilities of bulk and hydration water. The regression method assumes the intrinsic specific compressibility to be identical in different proteins

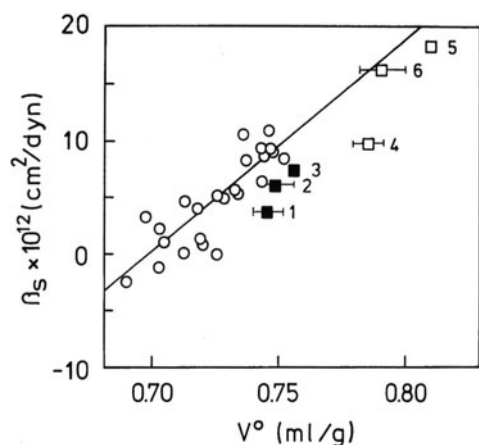

Fig. 4. Correlation between adiabatic compressibility and partial specific volume for various proteins. The results of Gekko and Hasegawa (1986) represented by the open circles and by the linear least-squares fit, are combined with the values found by Kaminsky and Richards for (■) reduced thioredoxin at 5, 15 and 30°C (1–3, respectively), and for (□) oxidized thioredoxin at 5, 15 and 30°C (4–6, respectively). Modified from Kaminsky and Richards (1992).

and attributes the variation of overall compressibilities mainly to the dependence of β on the surface area. Plotting β versus a term derived from the surface area, one obtains the hydrational contribution per area from the gradient of the regression. The disadvantage of this approach is that it only yields an average intrinsic compressibility for all the proteins under study. This result, however, is found to be in good agreement with the average of the independent results of the additive method (9.7×10^{-5} and 11.2×10^{-5} MPa $^{-1}$, respectively).

The lack of a reliable method for the discrimination of hydrational and intrinsic contributions is especially annoying in cases where anomalous compressibilities are observed. For instance, in a recent study on *E. coli* thioredoxin, oxidation of the protein was found to increase the partial specific volume and the adiabatic compressibility (Kaminsky and Richards, 1992). The values obtained for the reduced protein are well within the range of published data (Durchschlag, 1986; Gekko and Hasegawa, 1986). In contrast, the compressibility and partial specific volume of the oxidized form are anomalously high, β_s of oxidized thioredoxin is even the highest compressibility so far reported for a protein. Nevertheless, the correlation between compressibility and partial specific volume, which has been established by Gekko and Hasegawa (1986) is still valid (Fig. 4). At present, no explanation for this spectacular increase in volume and compressibility of *E. coli* thioredoxin can be provided. The authors speculate about cooperative effects in the solvent interface, which, however, still await to be specified and proven.

In contrast to these anomalously big differences in compressibility, Nölting and Sliger (1993) were surprised to find very little differences between the compressibilities of native cytochromes and their respective molten globule states. Again, interpretation of the result is ambiguous as long as hydrational and intrinsic contributions cannot reliably be separated.

The crystallographic method applied by Kundrot and Richards (1987, 1988) is based on a comparison of crystal structures of lysozyme obtained at 0.1 MPa and at 100 MPa. The overall compressibility of 4.7×10^{-5} MPa $^{-1}$ was ascribed to volume reductions exclusively located in the α -helical do-

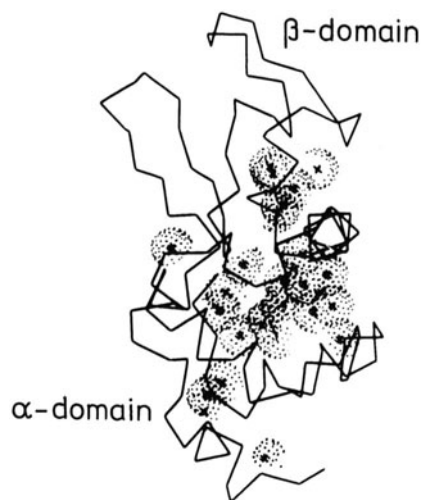

Fig. 5. Compressible structural regions in hen egg-white lysozyme, as monitored by crystallography at 100 MPa. The dotted spheres represent the van der Waals' surfaces of atoms whose packing volume decreased by more than 0.001 nm 3 upon pressurization (Kundrot and Richards, 1987).

main. The β -domain was found to be essentially incompressible (Fig. 5). Similarly, pressure-induced deformation was located mainly in the α -domain; however, only a few atoms moved more than 0.1 nm.

The fact that the intrinsic compressibility derived from high pressure crystallography is three times smaller than the results from sound velocimetry highlights the fundamental problem of comparing dynamic with static compression. Kharakoz and Sarvazyan (1993) assume that the effect of water molecules 'pressed into' the protein gives rise to additional relaxational contributions in the adiabatic compressibility. This would lead to an over-estimation of the intrinsic compressibility, whereas the same effect would cause an increase of the total protein volume and hence an under-estimation of the intrinsic contribution in the crystallographic approach. Hence, the authors suggest that the intrinsic compressibility of a protein should lie between $5\text{--}15 \times 10^{-7}$ MPa $^{-1}$. Fluorimetric distance determinations between tryptophan and heme groups in different heme proteins have led to the estimate that the intrinsic compressibilities of these proteins are higher than that of water, i.e. 49×10^{-7} MPa $^{-1}$ (Marden et al., 1986). However, no quantitative data are given. This approach is very sensitive to errors induced by even minor conformational changes and can only be applied if the geometry of the corresponding groups is certain to be maintained. More recently, enzymatic activities of monomeric enzymes have been used as probes for compression effects, as will be discussed in the following section.

Enzymatic activity: compression versus pulsation

In the past, enzymatic rate constants have commonly been assumed to show a linear pressure dependence from atmospheric pressure up to the onset of pressure-induced denaturation (cf. Eqn 2). However, this view has been challenged by measurements of the intrinsic compressibilities of proteins. The reduced specific volume of a pressurized protein has been proposed to bring a reduced flexibility and hence an inhibition of activity in cases where flexibility is crucial for biological function (Tsou, 1986; Huber, 1988; Groß et al., 1992). When this hypothesis was tested with

monomeric enzymes as model systems, a biphasic pressure dependence was observed for trypsin, and an even more complex profile for both directions of the reaction catalyzed by octopine dehydrogenase (Groß et al., 1993a). The latter result was interpreted as a consequence of the reduced flexibility of the monomeric dehydrogenase at pressures above 50 MPa. No such effects were found for lysozyme and thermolysin (Fukuda and Kunugi, 1984; Groß et al., 1993a).

A different view on non-linearity in the dependence of $\ln k$ on p was reported by Butz et al. (1988). In a detailed study of the pressure effects on the kinetics of fumarase, these authors attempt to attribute six different single-step activation volumes to the corresponding steps in the enzyme mechanism. They describe the resulting profile running through two maxima and a minimum of volume as a pulsation of the enzyme molecule. In a pulsating enzyme, the previously discussed compression effect would mainly act on the state with the maximum volume, i.e. highest compressibility. Since pressurization favours the reduction of the volume to the compact state, increasing pressure would bring the population of the intermediate states out of balance, thus slowing down the reaction; hence, the two views do not contradict each other.

Oligomeric proteins and multimeric protein assemblies

Pressure-dependent dissociation-association

As has been discussed in connection with monomeric proteins, pressure denaturation commonly requires pressures in the 100-MPa range. In contrast to this well documented finding, pressure-induced dissociation of oligomeric and multimeric proteins is observed well within the biologically relevant range of pressures and has, therefore, been discussed as a possible mechanism underlying the growth inhibition of microorganisms at high pressures (Jaenicke, 1981, 1987). Detailed studies on the pressure-induced dissociation/inactivation of NAD-dependent dehydrogenases (glyceraldehyde-3-phosphate dehydrogenase, lactate dehydrogenase and malate dehydrogenase) and of tryptophan synthase have revealed neat chemical equilibria according to



where N , M and M^* represent native tetramer, inactive monomer and (partially) unfolded monomer, respectively (Schmid et al., 1975; Schade et al., 1980a, b; Müller et al., 1982, 1984; Seifert et al., 1982, 1984). As an example, Fig. 6A summarizes results obtained for tryptophan synthase from *E. coli*. The unperturbed pressure-induced equilibrium is in contrast to other modes of dissociation-association (e.g. pH shifts or chaotropic agents) where aggregation is known to compete with correct association (Goldberg et al., 1991; Jaenicke and Buchner, 1993). Thus, thermodynamic data for quaternary structure formation can be obtained with high accuracy. The fact that the observed deactivation indeed reflects and parallels subunit dissociation has been unambiguously proven by hybridization, chemical cross-linking and concentration-dependent reconstitution experiments (Jaenicke, 1987, 1992).

In similar experiments, Weber and coworkers reported hysteresis phenomena ('conformational drift') and non-classical behaviour termed 'deterministic equilibrium' (King and Weber, 1986; Ruan and Weber, 1989; Erijman and Weber, 1991). This is to describe the finding that 'equilibrium' dissociation constants depend on concentration and differ

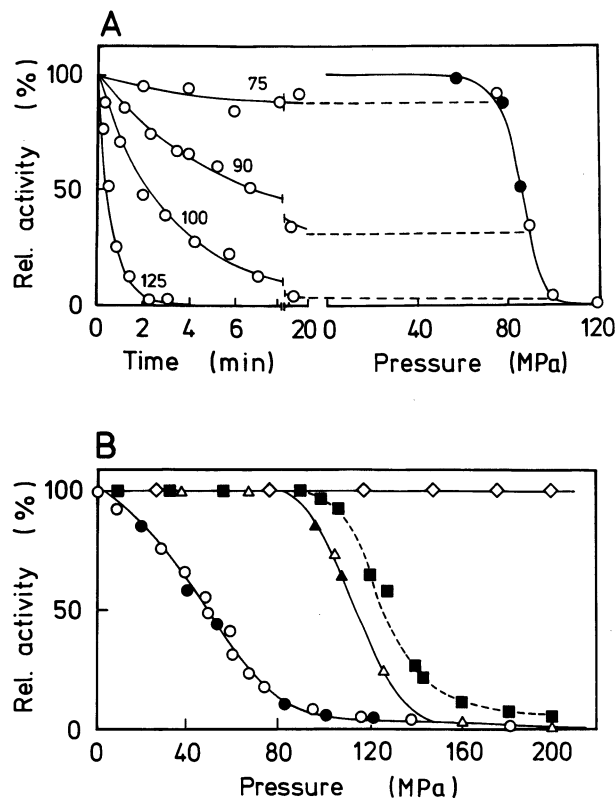

Fig. 6. Pressure-dependent deactivation, dissociation and reconstitution of oligomeric enzymes. (A) Pressure-induced deactivation of holo β_2 dimer of tryptophan synthase in 0.1 M triethanolamine pH 7.8, 0.1 M NaCl, 2 mM dithioerythritol, 0.5 mM EDTA. Left: time-dependent deactivation at 0.1 mg/ml and varying pressure (given in MPa), 10°C. Right: equilibrium transition; data represent final values after $\approx 10\times$ half-time in the forward (\circ) and backward direction (\bullet) (Seifert et al. 1985). (B) Pressure-dependent deactivation (\circ , \triangle , \diamond) and reactivation (\bullet , \blacksquare) of pig heart lactate dehydrogenase apoenzyme (\circ , \bullet) and holoenzyme, at $>94\%$ saturation with NAD^+ (\triangle , \blacktriangle); 0.1 M Tris/HCl pH 7.6, 10 mM dithioerythritol, 1 mM EDTA, 25 $\mu\text{g}/\text{ml}$, 20°C, $\approx 20\text{-h}$ incubation. Reactivation yield of (\circ) after 24-h reconstitution at 0.1 MPa (\blacksquare); 0.2 M phosphate stabilizes the enzyme in its native state (\diamond) (Schade et al., 1980b; Müller et al., 1981).

from the quotient of the forward and backward rate constants. For example, tetramers are proposed to exhibit an 'intermediate' behaviour between the classical 'stochastic' dissociation of dimers, and the 'deterministic' non-equilibrium dissociation found in large aggregates, e.g. in the extracellular hemoglobin of *Glossoscolex paulistus* (Silva et al., 1989; Erijman et al., 1993).

Ligand effects: Braun-Le Chatelier versus local stabilization

There is ample evidence from hydrodynamic, densimetric and X-ray small-angle scattering data that ligand binding to proteins may be accompanied by a significant increase in packing density. Monitoring heat- or pressure-dependent conformational alterations to follow the $N \rightarrow D$ transition, there are numerous examples which prove that coenzyme or substrate binding leads to enhanced stability, due to reduced flexibility of the polypeptide chain, i.e. increased compactness of the tertiary and/or quaternary structure. As an illustra-

tion, Fig. 6B shows the effect of NAD and phosphate on the pressure-induced deactivation of lactate dehydrogenase. The stabilization in both cases is evident; however, the mechanism is different. Phosphate (like sulfate) serves as a 'structural anion' in the native three-dimensional structure (compensating the destabilizing electrostatic interaction of two neighbouring cationic residues). In contrast, NAD causes a decrease of 5% in the hydrodynamic volume, involving conformational changes of the entire tetramer. Thus, the phosphate ion improves the stability by introducing additional ion pairs, whereas the NAD effect is governed by Braun-Le Chatelier's principle (Jaenicke et al., 1979; Schade et al., 1980a; Müller et al., 1981).

One important message from these results is that biologically relevant concentrations of ligands may have drastic effects on the intrinsic stability of a given protein. Therefore, conclusions from studies on isolated proteins regarding the cellular mechanism of growth inhibition (see above) have to be taken with care. One further example may serve to stress this caveat: in the case of glyceraldehyde-3-phosphate dehydrogenase, which is known to be structurally related to lactate dehydrogenase, pressure-induced deactivation is preceded by (apparent) activation. Here, for technical reasons, the measurements have to be performed at non-saturating NAD concentrations. Thus, due to the negative reaction volume of NAD binding ($\Delta V = -7\%$), and Braun-Le Chatelier's principle, pressure shifts the equilibrium toward the (active) holoenzyme (Schmid et al., 1975); only after having reached full saturation, at a limiting pressure, does the holoenzyme undergo deactivation and subunit dissociation, as described for lactate dehydrogenase and a number of other enzymes (Jaenicke, 1987). Most puzzling inactivation phenomena were observed by Masson and Balny (1990) for butyrylcholinesterase. Once more, they illustrate the complex involvement of ligands and subunits in the overall 'pressure denaturation' phenomena. The tetrameric enzyme, which is not dissociated by pressures up to 320 MPa, abruptly loses its activity at a threshold between 20–100 MPa, depending on both the substrate concentration and the solvent. In this case, the critical pressure decreases with increasing substrate concentration and solvent structure. The authors suggest that at the first threshold, the increased solvation of both enzyme and substrate leads to a dead-end complex. At a second, higher, pressure threshold (between 140–200 MPa) substrate binding is inhibited and finally, beyond 200 MPa, conformational changes occur. One final example which deserves to be mentioned in this context, is hemoglobin. Normal hemoglobin has been the object of high-pressure studies for many years and from diverse points of view (Heremans, 1982; Somero, 1992). Subunit interactions were addressed in a recent study combining fluorescence anisotropy with high-pressure fluorimetry (Pin et al., 1990). In this investigation, pressure was essentially used to follow the dimer→monomer transition. On the other hand, CO binding to tetrameric hemoglobin in its R and T state was studied by laser flash photolysis under high pressure (Unno et al., 1990). Similar investigations have been carried out on the (monomeric) sperm whale myoglobin (Taube et al., 1990). From the biological point of view, it is important to note that within the (amazingly large) range of diving depths of whales, there is no significant pressure effect on the O₂ saturation of hemoglobin and myoglobin, nor is there an oxygen gradient interfering with aerobic life (Johnson and McK Schlegel, 1948).

DNA-binding proteins

A recent study on the pressure-induced dissociation of the dimeric Arc repressor revealed that its dissociated form exhibits molten globule properties. This is indicated by a decrease in specific volume upon dissociation (7.69 $\mu\text{l/g}$), which the authors explain by the enhanced exposure of hydrophobic groups in the folded but conformationally changed monomer (Silva et al., 1992). In contrast, the Lac repressor system shows a 'normal' tetramer→dimer transition, with further dissociation to structured monomers at pH 9.2 (Royer et al., 1990). Binding of the inducer isopropyl β -D-thiogalactopyranoside does not affect the pressure sensitivity of this protein. On the other hand, binding of the operator DNA sequence destabilizes the tetramer considerably. Dissociation constants for histone octamers, tetramers and dimers have been determined by using fluorescence polarization under high pressure (Scarlatà et al., 1989).

Nucleoproteins and assembly systems

The observation that the disassembly of tobacco mosaic virus (TMV) can be accomplished by high pressure was reported half a century ago (Lauffer and Dow, 1941). When the same approach was applied to the isolated TMV protein, it became clear that the formation of the nucleoprotein complex is responsible for the extreme stability of the complete virus (Jaenicke et al., 1981). However, studies on similar systems revealed that this result cannot be generalized. Turnip yellow mosaic virus, for example, is stabilized by hydrostatic pressure against the thermally induced uncoating of its RNA. (Goldbeck et al., 1991). Considering the endothermic association of TMV protein (Jaenicke and Lauffer, 1969; Sturtevant et al., 1981; Jaenicke, 1991a), it seems as if different kinds of interactions dominated in both cases.

Although there have been attempts to use high-pressure studies in protein–nucleic-acid interactions, no systematic studies are available so far. Regarding the topology, a quite original approach to this problem has been chosen by Macgregor (1992), who used footprinting of *EcoRI* at high pressure to demonstrate the local dissociation and unshielding effects, which he interprets in terms of conformational changes of the protein. As already mentioned, studies on the Lac repressor system have revealed that the repressor-operator complex is less stable against pressure-induced dissociation than the tetrameric repressor alone. This suggests that the presence of DNA destabilizes the protein–protein interaction, in agreement with what one would expect from the classical concept of repressor function (Royer et al., 1990).

The bacterial ribosome has been investigated with regard to its pressure stability more intensively than any other nucleoprotein complex. Its dissociation at elevated hydrostatic pressure was first anticipated on the basis of indirect evidence from centrifugation experiments (Spirin, 1971) and then demonstrated directly by monitoring light-scattering as a function of pressure (Schulz et al., 1976a,b). The effect was discussed as a possible reason for the inhibition of protein biosynthesis and, hence, of cell growth by hydrostatic pressure (Jaenicke, 1987). However, the use of tight-couple ribosomes in high-pressure studies shifted the dissociation profiles to higher critical pressures, corresponding to the enhanced stability of this subspecies of ribosomes (Groß and Jaenicke, 1990). The use of a new buffer system developed in order to maintain *in-vivo*-like performance of protein biosynthesis *in vitro* (Bartetzko and Nierhaus, 1988) led to con-

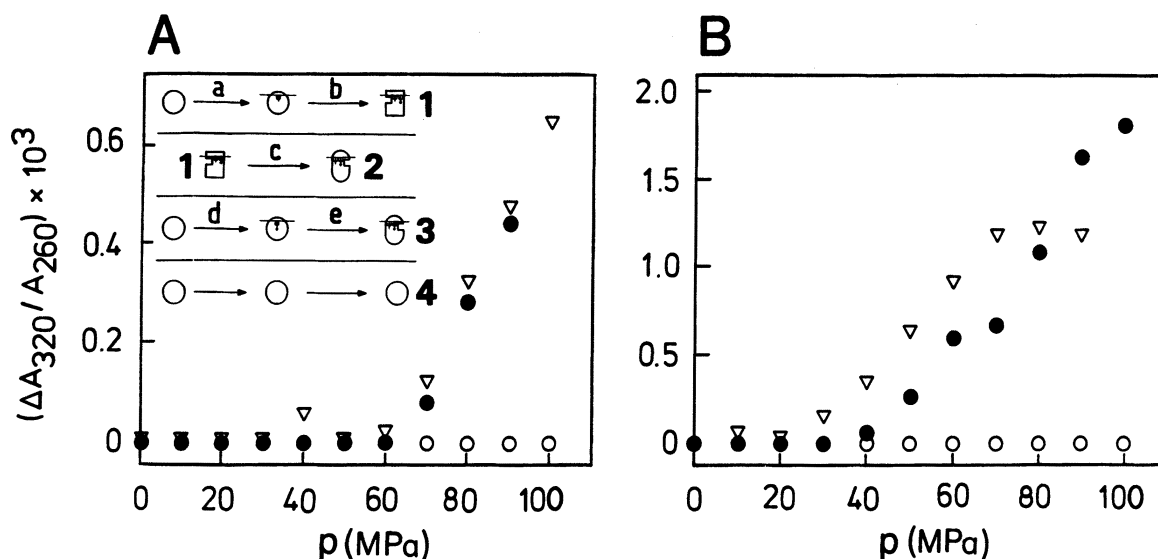

Fig. 7. High-pressure turbidity measurements on tight couple ribosomes and functional complexes. Pressure-induced dissociation of ribosomes is monitored as the relative decrease in light scattering at 320 nm. For standardization, the results are divided by the ribosome concentration measured as A_{260} . The samples are (1) pre-translocational ribosome (prepared non-enzymically: deacylated tRNA in P-site, AcPhe-tRNA in A-site); (2) post-translocational ribosome complex (prepared by EF-G-catalyzed translocation of complex 1: deacylated tRNA in E-site, AcPhe-tRNA in P-site); (3) 'post-translocational ribosome' (prepared non-enzymically); (4) uncharged tight couples run through the same incubation scheme as compounds 1–3 without adding tRNA or poly(U) (cf. Groß et al., 1993b). Functional states of the ribosome are defined according to the allosteric three-sites model, as reviewed by Nierhaus (1990). (A) Results obtained in Hepes/polyamine buffer system with $[Mg^{2+}] = 10$ mM: (○) functional complexes 1–3; (●) uncharged reference sample 4; (▽) untreated tight couples. Insert: schematic representation of the functional complexes, with tRNA sites (from left to right): exit site E, peptidyl-tRNA site P, and aminoacyl-tRNA site A. ⊕ symbolizes uncharged tRNA, the triangle at the bottom of the aminoacyl-receptor arm, the AcPhe residue. Circles, rectangles and oval forms represent uncharged or incompletely charged ribosomes, pre-translocational complexes, and post-translocational complexes, respectively. Reaction (a) addition of poly(U) and tRNA^{Phe}; (b) Ac[¹⁴C]Phe-tRNA^{Phe}; (c) EF-G; (d) poly(U) and Ac[¹⁴C]Phe-tRNA^{Phe}; (e) tRNA^{Phe}. (B) Pressure-induced dissociation of functional complexes and uncharged ribosomes at 10 mM Mg^{2+} + 6 mM EDTA (effective $[Mg^{2+}] = 4$ mM): (○) samples 1 and 3; (●) sample 2; (▽) sample 4.

ditions which stabilize tight-couple ribosomes up to 60 MPa; functional ribosomal complexes even retain their state of association over the whole range of biologically relevant pressures (Fig. 7) (Groß et al., 1992, 1993b). This result has been obtained by turbidity measurements and from sedimentation patterns in the analytical ultracentrifuge. Approaching the physiological magnesium ion concentration, one finds that only the uncharged ribosome and the post-translocational complex are destabilized to a significant extent. Thus, mimicking the cellular environment by optimizing the solvent conditions, stabilization of ribosomes against pressure-induced dissociation is observed; however, under conditions where dissociation of the ribosome is limiting the overall translation reaction, the post-translocational complex becomes the weakest point where high pressure may affect protein biosynthesis. Thus, the questions remain: how does pressure induce inhibition of bacterial growth and how do barophilic organisms cope with high-pressure stress? At present, neither question can be answered in a satisfactory way.

Obviously, DNA synthesis in *E. coli* continues unperturbed at pressures where protein synthesis is already blocked (Schwarz and Landau, 1972; Welch et al., 1993). However, it is of interest to note that pressure promotes the B→Z transition of DNA (Krzyzaniak et al., 1991) whereas, in general, the double-helical structure of DNA seems to be unaffected over the whole range of biologically relevant pressures. According to another more recent observation, high pressure allows a non-enzymatic, but nevertheless specific, aminoacylation of tRNAs to be performed (A. Krzyzaniak, unpublished results). What these results mean in terms of barophilic

adaptation and the evolution of the translational apparatus remains to be shown.

Protein crystallization

Protein crystallization is a self-assembly process which proceeds from monomer via a futile (postulated) oligomeric intermediate, termed nucleus, to large and regular arrays of protein molecules. Crystallization of protein toxins *in vivo* has been observed in the cells of *Bacillus thuringiensis* (Thomas and Ellar, 1983) and has recently been reported to involve specialized molecular chaperones (Wu and Federici, 1993). The toxin can be stored without doing any harm, but it can rapidly be activated when the crystals are dissolved by the gastric acid of the host (D. J. Ellar, personal communication). Thus, protein crystallization is indeed a natural phenomenon and should not be regarded solely as a method to obtain X-ray diffraction and electron density maps, but also as a model system for the study of protein assembly.

The first report on protein crystal growth under pressure (Visuri et al., 1990) revealed that the yields of small crystals of glucose isomerase can be enhanced by application of pressure. However, this study did not contain any systematic investigation of the effect allowing thermodynamic conclusions. In contrast, the crystallization of hen egg-white lysozyme under standard conditions (pH 4.7, 0.8 M NaCl) was found to be strongly inhibited by hydrostatic pressure (Groß and Jaenicke, 1991). At 100 MPa, both the crystallization kinetics and the equilibrium solubility of lysozyme are

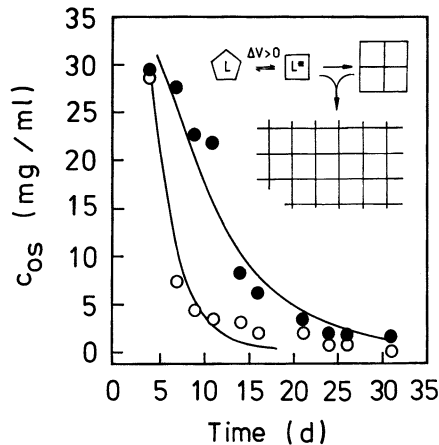

Fig. 8. Kinetics of lysozyme crystallization at 100 MPa and at atmospheric pressure. Crystallization is induced by NaCl diffused through an agarose gel into the protein solution (acetate pH 4.66). Crystals are removed by centrifugation, and the residual oversaturation of the mother liquor (c_{0s}) is monitored spectrophotometrically as a function of incubation time. (○) Atmospheric pressure; (●) 100 MPa (cf. Groß and Jaenicke, 1991).

shifted toward lower yields of crystallization (Fig. 8). From this result, a reaction volume of -11.5 ml/mol was calculated, which was confirmed by dilatometry. Surprisingly, dilatometric measurements revealed a rapid volume change, whereas pressure-jump experiments showed that the pressure sensitivity of the yields of crystallization is maintained even when pressure is applied rather late in the experiment (Groß and Jaenicke, 1992, 1993). This apparent contradiction could be resolved in a kinetic model based on the Oosawa theory of protein self-assembly, which was first applied to crystallization by Ataka and Asai (1990). In addition to the nucleation and propagation steps assumed by this theory, a pressure-dependent pre-equilibrium between a crystallization-competent form L^* and a non-competent form L was introduced (insert, Fig. 8, cf. Groß and Jaenicke, 1993). High-pressure crystallization experiments can then be simulated by replacing the initial protein concentration by a reduced concentration of the competent monomer. The L/L^* equilibrium provides an independent way to obtain the reaction volume from the half-times of crystallization. The result obtained (11.9 ml/mol) is in good agreement with the result of the equilibrium thermodynamics. Furthermore, all of the experimental results could be simulated by algorithms based on this kinetic model. These results provide a working model of how pressure may act on protein self-assembly. However, from the available data one cannot draw conclusions as to what is the exact difference between L and L^* . Hydration changes or conformational changes of the protein may be responsible for these effects. Evidently, the kinetic model is not limited to inhibitory effects but may also explain an enhancement of crystallization as found by Visuri et al. (1990).

Conclusions and outlook

Mechanisms and limits of adaptation

Adaptational response toward high hydrostatic pressure is still far from being understood. Although heat-shock treatment confers pressure resistance to yeast (Iwahashi et al., 1991), the well characterized heat-shock response (Lindquist, 1986; Nover, 1991) does not provide means to elucidate the

high pressure case. This holds in spite of the fact that a 'pressure-shock response' has been detected at both the protein and mRNA level (Jaenicke et al., 1988; Bartlett et al., 1989; Welch et al., 1993). Biochemical investigations on pressure-sensitive systems must be screened for crucial mechanisms of sensitivity, such as dissociation/compression of the post-translocational ribosomal complex, dissociation of multimeric protein assemblies, etc. The next step will be to have a closer look at the barophilic organisms, which are scarcely available today, and to study their phylogenetic relationships. Up to now, no 'standard' barophilic organism has emerged. This lack of suitable systems is a major handicap for the investigation of biochemical mechanisms underlying high pressure adaptation.

There have been claims that the limits of this adaptation extend into centres of volcanic action in the deep sea, i.e. 25 MPa and 300°C . However, careful studies on the stability of polypeptides and amino acids as well as nucleic acids and nucleotides, and of the kinetics of their hydrothermal decomposition, have shown that there is no life under 'black smoker' conditions. The upper temperature limit for the stability of proteins, amino acids or nucleotides and most other biomolecules is of the order of $120 \pm 20^\circ\text{C}$; the half-times of decompositions under the above conditions of pressure and temperature are too short to allow a compensation of the loss by resynthesis (Bernhardt et al., 1984; White, 1984; Trent et al. 1984).

One most important subject in the given context is the biological membrane. Although not in the main focus of this review, its significance for the adaptation to the high-pressure/low-temperature conditions of the deep sea must not be ignored (Macdonald, 1984, 1992). High pressures and low temperatures both act in the same direction of making the membranes more rigid, thus presumably interfering with their functions. The strategy of homeoviscous adaptation is well established for low temperatures, and has also been demonstrated for high-pressure conditions (Cossins and Macdonald, 1986). For example, in fish caught from different depths, the content of unsaturated lipids correlates with the hydrostatic pressure of the natural habitat, thus providing a constant fluidity *in situ* (Cossins and Macdonald, 1989). More recently, this concept could also be verified for neurocytes and myelinated membranes (Macdonald, 1988; Behan et al., 1992).

The effects of pressure on the activity of membrane proteins has been studied with the Na^+/K^+ -ATPase from teleost gills (Gibbs and Somero, 1990). Again, the decrease of activity was found to correlate with the reduction of membrane fluidity. Correspondingly, homologous systems from deep-sea organisms were found to be more resistant against pressure-induced inactivation. For details, see the reviews of Somero (1992) and Macdonald (1992). Biochemical electron-transfer reactions at elevated pressure have been reviewed by Heremans (1982, 1987). Recent experimental studies in this field focused mainly on cytochromes (di Primo et al., 1990; Heiber-Langer et al., 1992a,b; Kornblatt et al., 1992).

In the biosphere, as already mentioned, high pressure and low temperature go together. In asking which of the two parameters is more relevant from the point of view of evolution, it seems clear that adaptation to deep-sea conditions is dominated by low temperature rather than high pressure. The reason is that, on changing from sea level to the ocean floor, 20°C difference in temperature may decelerate reaction rates by a factor of 4–10 (depending on the energy of activation),

whereas effects of the increase in pressure will hardly exceed 15%, if no pressure-induced deactivation is involved.

Applications in biotechnology

In contrast to the still unresolved problems in high-pressure biology, the application of pressure in biotechnology is on the threshold of success. Two main trends can be distinguished: supercritical fluids and food technology.

Supercritical carbon dioxide ($t_c = 31^\circ\text{C}$, $p_c = 7.4\text{ MPa}$) has been used as a solvent for the extraction of natural substances and for the application of enzymic reactions on a biotechnological scale (Perrut, 1992; Martins et al., 1992). There is a multitude of applications and growing industrial involvement in this area.

Concerning food technology, applications of high hydrostatic pressure in food sterilization and processing have been a central issue of research and development in Japan for more than a decade (Hayashi, 1989, 1992). In contrast, food technology in Europe is only beginning to enter this field (Balny et al., 1992). High pressure has been shown to be a useful approach to inactivate microorganisms (Hoover et al., 1989), denature proteins, gelatinate starch, inactivate enzymes, as well as produce and process jam, chocolate and other foods (Hayashi, 1992). High pressure, in contrast to high-temperature treatment, is specific in so far as (a) it does not provoke a Maillard reaction, (b) it does not affect covalent bonds, hence cannot destroy natural flavours or colorants, as temperature does, and (c) it allows the production of half-prepared foods. High-pressure processes will surely provide new quality foods. As a side effect, the wish for a better understanding of the processes involved in pressure-induced preservation and processing of food will certainly promote the research activities in the highly stimulating but still neglected field of high-pressure biochemistry.

Work performed in the author's laboratory was financed by grants of the *Deutsche Forschungsgemeinschaft*, the *Fonds der Chemischen Industrie* and the European Community. The doctoral thesis of M. G. was supported by the *Friedrich Ebert Stiftung*. R. J. thanks the Fogarty International Center for Advanced Studies for generous support and hospitality. Expert technical assistance of Ms Eva Gregori is gratefully acknowledged.

REFERENCES

- Ataka, M. & Asai, M. (1990) Analysis of the nucleation and crystal growth kinetics of lysozyme by a theory of self-assembly, *Bio-phys. J.* **58**, 807–811.
- Balny, C., Masson, P. & Travers, F. (1989) Some recent aspects of the use of high-pressure for protein investigations in solution, *High Pressure Res.* **2**, 1–28.
- Balny, C., Hayashi, R., Heremans, K. & Masson, P. (eds) (1992) *High pressure and biotechnology*, *Colloq. Inserm* **224**.
- Bartetzko, A. & Nierhaus, K. H. (1988) $\text{Mg}^{2+}/\text{NH}_4^+$ /Polyamine system for polyuridine-dependent polyphenylalanine synthesis with near *in vivo* characteristics, *Methods Enzymol.* **164**, 650–658.
- Bartlett, D., Wright, M., Yayanos, A. A. & Silverman, M. (1989) Isolation of a gene regulated by hydrostatic pressure in a deep-sea bacterium, *Nature* **342**, 572–574.
- Behan, M. K., Macdonald, A. G., Jones, G. R. & Cossins, A. R. (1992) Homoviscous adaptation under pressure: the pressure dependence of membrane order in brain myelin membranes of deep-sea fish, *Biochim. Biophys. Acta* **1103**, 317–323.
- Bernhardt, G., Lüdemann, H.-D. & Jaenicke, R. (1984) Biomolecules are unstable under "black smoker" conditions, *Naturwissenschaften* **71**, 583–585.
- Bernhardt, G., Jaenicke, R. & Lüdemann, H.-D. (1987) High-pressure equipment for growing methanogenic microorganisms on gaseous substrates at high temperature, *Appl. Environ. Microbiol.* **53**, 1876–1879.
- Bernhardt, G., Distèche, A., Jaenicke, R., Koch, B., Lüdemann, H.-D. & Stetter, K. O. (1988a) Effect of carbon dioxide and hydrostatic pressure on the pH of culture media and the growth of methanogens at elevated temperature, *Appl. Microbiol. Biotechnol.* **28**, 176–181.
- Bernhardt, G., Jaenicke, R., Lüdemann, H.-D., König, H. & Stetter, K. O. (1988b) High pressure enhances the growth rate of the thermophilic archaeobacterium *Methanococcus thermolithotrophicus* without extending its temperature range, *Appl. Environ. Microbiol.* **54**, 1258–1261.
- Brandts, J. F., Oliveira, R. J. & Westort, C. (1970) Thermodynamics of protein denaturation. Effect of pressure on the denaturation of ribonuclease A, *Biochemistry* **9**, 1038–1047.
- Bridgman, P. W. (1914) The coagulation of albumen by pressure, *J. Biol. Chem.* **19**, 511–512.
- Butz, P., Greulich, K. O. & Ludwig, H. (1988) Volume changes during enzyme reactions: indications of enzyme pulsation during fumarase catalysis, *Biochemistry* **27**, 1556–1563.
- Certes, A. (1884a) Sur la culture, à l'abri des germes atmosphériques, des eaux et des sédiments rapportés par les expéditions du Travailleur et du Talisman, *Compt. Rend.* **98**, 690–693.
- Certes, A. (1884b) De l'action des hautes pressions sur les phénomènes de la putréfaction et sur la vitalité des micro-organismes d'eau douce et d'eau de mer, *Compt. Rend.* **99**, 385–388.
- Cléry, C. & Masson, P. (1992) High pressure and biotechnology, *Colloq. Inserm* **224**, 533–535.
- Cossins, A. R. & Macdonald, A. G. (1986) Homeoviscous adaptation under pressure. III. The fatty acid composition of liver mitochondrial phospholipids of deep-sea fish, *Biochim. Biophys. Acta* **860**, 325–335.
- Cossins, A. R. & Macdonald, A. G. (1989) The adaptation of biological membranes to temperature and pressure: fish from the deep and cold, *J. Bioenerg. Biomembr.* **21**, 115–135.
- Davis, B. J. & Siebenaller, J. F. (1992) Proteolysis at pressure and HPLC peptide mapping of M_r -LDH homologs from marine fishes living at different depths, *Int. J. Biochem.* **24**, 1135–1139.
- Deming, J. W., Somers, L. K., Straube, W. L., Swartz, D. G. & MacDonell, M. T. (1988) Isolation of an obligately barophilic bacterium and description of a new genus, *Colwellia* gen. nov., *System. Appl. Microbiol.* **10**, 152–160.
- Dietz, A. S. & Yayanos, A. A. (1978) Silica gel media for isolating and studying bacteria under hydrostatic pressure, *Appl. Environ. Microbiol.* **36**, 966–968.
- Dill, K. A. (1990) Dominant forces in protein folding, *Biochemistry* **29**, 7133–7155.
- Di Primo, C., Hui Bon Hoa, G., Douzou, P. & Sligar, S. (1990) Effect of the tyrosine 96 hydrogen bond on the inactivation of cytochrome $P-450_{\text{cam}}$ induced by hydrostatic pressure, *Eur. J. Biochem.* **193**, 383–386.
- Distèche, A. (1972) Effects of pressure on the dissociation of weak acids, *Symp. Soc. Exp. Biol.* **26**, 27–60.
- Dufour, E., Hervé, G. & Haertlé, T. (1992) High pressure and biotechnology, *Colloq. Inserm* **224**, 147–150.
- Durchschlag, H. (1986) in *Thermodynamic data for biochemistry and biotechnology* (Hinz, H.-J., ed.) pp. 45–128, Springer Verlag Berlin, Heidelberg, New York, Tokyo.
- Erijman, L. & Weber, G. (1991) Oligomeric protein associations: transition from stochastic to deterministic equilibrium, *Biochemistry* **30**, 1595–1599.
- Erijman, L., Lorimer, G. H. & Weber, G. (1993) Reversible dissociation and conformational stability of dimeric ribulose biphosphate carboxylase, *Biochemistry* **32**, 5187–5195.
- Franks, F. (ed.) (1972–1982) *Water: A Comprehensive Treatise*, vols 1–7, Plenum, New York.
- Franks, F. (ed.) (1985–1990) *Water Science Reviews*, vols 1–5, Cambridge University Press, Cambridge.
- Fukuda, M. & Kunugi, S. (1984) Pressure dependence of thermolysin catalysis, *Eur. J. Biochem.* **142**, 565–570.

- Gekko, K. & Hasegawa, Y. (1986) Compressibility-structure relationship of globular proteins, *Biochemistry* 25, 6563–6571.
- Gekko, K. & Hasegawa, Y. (1989) Effect of temperature on the compressibility of native globular proteins, *J. Phys. Chem.* 93, 426–429.
- Gibbs, A. & Somero, G. N. (1990) Pressure adaptation of teleost gill Na⁺/K⁺-ATPase: role of the lipid and protein moieties, *J. Comp. Physiol. B* 160, 431–439.
- Goldbeck, A., Lechner, M. D., Witz, J., Nordmeier, E. & Ibel, K. (1991) The thermal stability of turnip yellow mosaic virus under hydrostatic pressure. A small angle neutron scattering study, *Eur. Biophys. J.* 20, 151–156.
- Goldberg, M. E., Jaenicke, R. & Rudolph, R. (1991) A kinetic study of the competition between renaturation and aggregation during the refolding of denatured-reduced egg-white lysozyme, *Biochemistry* 30, 2790–2797.
- Groß, M. & Jaenicke, R. (1990) Pressure-induced dissociation of tight couple ribosomes, *FEBS Lett.* 267, 239–241.
- Groß, M. & Jaenicke, R. (1991) Growth inhibition of lysozyme crystals at high hydrostatic pressure, *FEBS Lett.* 284, 87–90.
- Groß, M. & Jaenicke, R. (1992) High pressure and biotechnology, *Colloq. Inserm* 224, 83–87.
- Groß, M., Jaenicke, R. & Nierhaus, K. H. (1992) High pressure and biotechnology, *Colloq. Inserm* 224, 159–161.
- Groß, M. & Jaenicke, R. (1993) A kinetic model explaining the effects of hydrostatic pressure on nucleation and growth of lysozyme crystals, *Biophys. Chem.* 45, 245–252.
- Groß, M., Auerbach, G. & Jaenicke, R. (1993a) The activities of monomeric enzymes show complex pressure-dependence, *FEBS Lett.* 321, 256–260.
- Groß, M., Lehle, K., Jaenicke, R. & Nierhaus, K. H. (1993b) Pressure-induced dissociation of ribosomes and elongation cycle intermediates. Stabilizing conditions and identification of the most sensitive functional state, *Eur. J. Biochem.* 218, 463–468.
- Harrington, W. F. & Kegeles, G. (1973) Pressure effects in ultracentrifugation of interacting systems, *Methods Enzymol.* 27, 306–345.
- Harris, R. D., Jacobs, M., Long, M. M. & Urry, D. W. (1976) A high-pressure sample cell for circular dichroism studies, *Anal. Biochem.* 73, 363–368.
- Hawley, S. A. (1971) Reversible pressure-temperature denaturation of chymotrypsinogen, *Biochemistry* 10, 2436–2442.
- Hawley, S. A. (1978) High-pressure techniques, *Methods Enzymol.* 49, 14–24.
- Hayashi, R. (1989) in *Engineering and Food 2* (Spiess, W. E. L. & Schubert, H., eds) pp. 815–826, Elsevier Applied Science, Amsterdam.
- Hayashi, R. (1992) High pressure and biotechnology, *Colloq. Inserm* 224, 185–193.
- Heiber-Langer, I., Hooper, A. B. & Balny, C. (1992a) Pressure modulation of cytochrome-to-cytochrome electron transfer. Models and enzyme reactions, *Biophys. Chem.* 43, 265–277.
- Heiber-Langer, I., Cléry, C., Frank, J., Masson, P. & Balny, C. (1992b) Interaction of cytochrome c₁ with methanol dehydrogenase from *Methylophaga marina* 42: thermodynamic arguments for conformational change, *Eur. Biophys. J.* 21, 241–250.
- Heremans, K. (1982) High pressure effects on proteins and other biomolecules, *Annu. Rev. Biophys. Bioeng.* 11, 1–21.
- Heremans, K. (1987) in *Current perspectives in high pressure biology* (Jannasch, H. W. et al., eds) pp. 225–244, Academic Press, London.
- Hoover, D. G., Metrick, C., Papineau, A. M., Farkas, D. F. & Knorr, D. (1989) Biological effects of high hydrostatic pressure on food microorganisms, *Food Technol.* 43, 99–107.
- Huber, R. (1988) Flexibility and rigidity of proteins and protein-pigment complexes, *Angew. Chem. Int. Ed. Engl.* 27, 79–88.
- Iwahashi, H., Kaul, S. C., Obuchi, K. & Komatsu, Y. (1991) Induction of barotolerance by heat shock treatment in yeast, *FEMS Microbiol. Lett.* 80, 325–328.
- Jaenicke, R. & Lauffer, M. A. (1969) Polymerization-depolymerization of TMV-protein: studies on the role of water, *Biochemistry* 8, 3083–3092.
- Jaenicke, R., Gregori, E. & Laepple, M. (1979) Hydrodynamic and spectral effects upon ligand binding to porcine LDH, *Biophys. Struct. Mech.* 6, 57–65.
- Jaenicke, R. (1981) Enzymes under extremes of physical conditions, *Annu. Rev. Biophys. Bioeng.* 10, 1–67.
- Jaenicke, R., Lüdemann, H.-D. & Schade, B. C. (1981) High pressure effects on the endothermic association of TMV protein, *Biophys. Struct. Mech.* 7, 195–203.
- Jaenicke, R. (1987) in *Current perspectives in high pressure biology* (Jannasch, H. W. et al. eds) pp. 257–272, Academic Press, London.
- Jaenicke, R., Bernhardt, G., Lüdemann, H.-D. & Stetter, K. O. (1988) Pressure induced alterations in the protein pattern of the thermophilic archaeobacterium *Methanococcus thermolithotrophicus*, *Appl. Environ. Microbiol.* 54, 2375–80.
- Jaenicke, R. (1991a) Protein folding: local structures, domains, subunits, and assemblies, *Biochemistry* 30, 3147–3161.
- Jaenicke, R. (1991b) Protein stability and molecular adaptation to extreme conditions, *Eur. J. Biochem.* 202, 715–728.
- Jaenicke, R. (1992) Protein stability, folding and association, in *Application potential of immobilized macromolecules* (Sleytr, U. B., ed.) pp. 1–21, Springer Verlag, Berlin, Heidelberg, New York.
- Jaenicke, R. & Buchner, J. (1993) Protein folding: from "unboiling an egg" to "catalysis of folding", *Chemtracts Biochem. Mol. Biol.* 4, 1–30.
- Jannasch, H. W. & Taylor, C. D. (1984) Deep-sea microbiology, *Annu. Rev. Microbiol.* 38, 487–514.
- Jannasch, H. W. (1985) Leben in der Tiefsee auf chemosynthetischer Basis, *Naturwissenschaften* 72, 285–290.
- Jannasch, H. W. (1987) in *Current perspectives in high pressure biology* (Jannasch, H. W. et al., eds) pp. 1–16, Academic Press, London.
- Jannasch, H. W., Marquis, R. E. & Zimmerman, A. M. (eds) (1987) *Current perspectives in high pressure biology*, Academic Press, London.
- Johnson, F. H. & McK. Schlegel, F. (1948) Hemoglobin oxygenation in relation to hydrostatic pressure, *J. Cell. Comp. Physiol.* 31, 421–425.
- Jonas, J. (1992) High pressure and biotechnology, *Colloq. Inserm* 224, pp. 123–127.
- Kaminsky, S. M. & Richards, F. M. (1992) Reduction of thioredoxin significantly decreases its partial specific volume and adiabatic compressibility, *Protein Sci.* 1, 22–30.
- Kauzmann, W. (1959) Some factors in the interpretation of protein denaturation, *Adv. Protein Chem.* 14, 1–67.
- Kharakoz, D. P. (1991) Volumetric properties of proteins and their analogues in dilute water solutions. 2. Partial adiabatic compressibilities of amino acids at 15–70°C, *J. Phys. Chem.* 95, 5634–5642.
- Kharakoz, D. P. & Sarvazyan, A. P. (1993) Hydrational and intrinsic compressibilities of globular proteins, *Biopolymers* 33, 11–26.
- King, L. & Weber, G. (1986) Conformational drift of dissociated LDH, *Biochemistry* 25, 3632–3637.
- Kornblatt, J. A., Theodorakis, J., Hui Bon Hoa, G. & Margoliash, E. (1992) Cytochrome c and cytochrome c oxidase interactions: the effects of ionic strength and hydrostatic pressure studied with site-specific modifications of cytochrome c, *Biochem. Cell. Biol.* 70, 539–547.
- Kraulis, P. J. (1991) MOLSCRIPT: a program to produce both detailed and schematic plots of protein structures, *J. Appl. Crystallogr.* 24, 946–950.
- Krzyzaniak, A., Salanski, P., Jurczak, J. & Barciszewski, J. (1991) B-Z DNA reversible conformation changes effected by high pressure, *FEBS Lett.* 279, 1–4.
- Kundrot, C. E. & Richards, F. M. (1987) Crystal structure of hen egg-white lysozyme at a hydrostatic pressure of 1000 atmospheres, *J. Mol. Biol.* 193, 157–170.
- Kundrot, C. E. & Richards, F. M. (1988) Effect of hydrostatic pressure on the solvent in crystals of hen egg-white lysozyme, *J. Mol. Biol.* 200, 401–410.
- Lang, E. W. & Lüdemann, H.-D. (1982) Anomalies of liquid water, *Angew. Chem. Int. Ed. Engl.* 21, 315–329.

- Lang, E. W. & Lüdemann, H.-D. (1990) High-pressure NMR studies on water and aqueous solutions in *NMR basic principles and progress* (Diehl, P., Fluck, E., Günther, H., Kosfeld, R. & Seelig, J., eds) vol. 24, 129–187, Springer Verlag, Heidelberg, Berlin, New York.
- Laufer, M. A. & Dow, R. B. (1941) Denaturation of TMV at high pressure, *J. Biol. Chem.* 140, 509–518
- Li, T. M., Hook, J. W., Drickamer, H. G. & Weber, G. (1976) Plurality of pressure-denatured forms in chymotrypsinogen and lysozyme, *Biochemistry* 15, 5571–5580.
- Lindquist, S. (1986) The heat-shock response, *Annu. Rev. Biochem.* 55, 1151–1191.
- Lorenz, R. (1993) *Kultivierung mariner Pilze unter erhöhtem hydrostatischem Druck*, Doctoral thesis, University of Regensburg.
- Lorenz, R. & Molitoris, H. P. (1992a) High pressure and biotechnology, *Colloq. Inserm* 224, 315–319.
- Lorenz, R. & Molitoris, H. P. (1992b) High pressure and biotechnology, *Colloq. Inserm* 224, 537–539.
- Lüdemann H.-D. (1992) High pressure and biotechnology, *Colloq. Inserm* 224, 371–379.
- Macdonald, A. G. (1984) The effects of pressure on the molecular structure and physiological functions of cell membranes, *Phil. Trans. R. Soc. Lond. B* 304, 47–68.
- Macdonald, A. G. (1988) Application of the theory of homeoviscous adaptation to excitable membranes: pre-synaptic processes, *Biochem. J.* 256, 313–327.
- Macdonald, A. G., Ramsey, R. L., Shelton, C. J. & Usherwood, P. N. R. (1989) An apparatus for single-channel patch recording at high pressure, *J. Physiol. (Lond.)* 409, 2P.
- Macdonald, A. G. (1992) High pressure and biotechnology, *Colloq. Inserm* 224, 67–75.
- Macgregor, R. B. (1992) Footprinting of EcoRI endonuclease at high pressure, *Biochim. Biophys. Acta* 1129, 303–308.
- Marden, M. C., Hui Bon Hoa, G. & Stetzkowski-Marden, F. (1986) Heme protein fluorescence versus pressure, *Biophys. J.* 49, 619–627.
- Marquis, R. E. (1982) Microbial barobiology, *Bioscience* 32, 267–271.
- Martins J. F., Sampaio, T. C., Carvalho, I. B., Nunes da Ponte, M. & Barreiros, S. (1992) High pressure and biotechnology, *Colloq. Inserm* 224, 411–415.
- Masson, P. & Balny, C. (1990) Conformational plasticity of butyrylcholinesterase as revealed by high pressure experiments, *Biochim. Biophys. Acta* 1041, 223–231.
- Morild, E. (1981) The theory of pressure effects on enzymes, *Adv. Protein Chem.* 34, 93–163.
- Müller, K., Lüdemann, H.-D. & Jaenicke, R. (1981) Pressure-induced structural changes of pig heart LDH, *Biophys. Chem.* 14, 101–110.
- Müller, K., Lüdemann, H.-D. & Jaenicke, R. (1982) Thermodynamics and mechanism of high-pressure deactivation and dissociation of porcine lactic dehydrogenase, *Biophys. Chem.* 16, 1–7.
- Müller, K., Seifert, T. & Jaenicke, R. (1984) High pressure dissociation of LDH from *Bacillus stearothermophilus* and reconstitution of the enzyme after denaturation in 6 M guanidine hydrochloride, *Eur. Biophys. J.* 11, 87–94.
- Nierhaus, K. H. (1990) The allosteric three-site model for the ribosomal elongation cycle: features and future, *Biochemistry* 29, 4997–5008.
- Nöltling, B. & Sligar, S. G. (1993) Adiabatic compressibility of molten globules, *Biochemistry* 32, 12319–12323.
- Nover, L. (ed.) (1991) Heat shock response, CRC Press, Boca Raton, FL.
- Perrut, M. (1992) High pressure and biotechnology, *Colloq. Inserm* 224, 401–410.
- Perutz, M. F. & Raidt (1975) Stereochemical basis of heat stability in bacterial ferredoxins and in hemoglobin A2, *Nature* 255, 256–259.
- Pin, S., Royer, C. A., Gratton, E., Alpert, B. & Weber, G. (1990) Subunit interactions in hemoglobin probed by fluorescence and high-pressure techniques, *Biochemistry* 29, 9194–9202.
- Privalov, P. L. (1993) in *Protein folding* (Creighton, T. E., ed.) pp. 83–126, W. H. Freeman & Co., New York.
- Radford, S. E., Dobson C. M. & Evans P. A. (1992) The folding of hen lysozyme involves partially structured intermediates and multiple pathways, *Nature* 358, 302–307.
- Redfield, C. & Dobson, C. M. (1988) Sequential ¹H NMR assignments and secondary structure of hen egg white lysozyme in solution, *Biochemistry* 27, 122–136.
- Richards, F. M. (1977) Areas, volumes, packing and protein structure, *Annu. Rev. Biophys. Bioeng.* 6, 151–176.
- Royer, C. A., Chakerian, A. E. & Matthews, K. S. (1990) Macromolecular binding equilibria in the lac repressor system: studies using high-pressure fluorescence spectroscopy, *Biochemistry* 29, 4959–4966.
- Royer, C. A., Hinck, A. P., Loh, S. N., Prehoda, K. E., Peng, X., Jonas, J. & Markley, J. L. (1993) Effects of amino acid substitutions on the pressure denaturation of staphylococcal nuclease as monitored by fluorescence and nuclear magnetic resonance spectroscopy, *Biochemistry* 32, 5222–5232.
- Ruan, K. & Weber, G. (1989) Hysteresis and conformational drift of pressure-dissociated glyceraldehydephosphate dehydrogenase, *Biochemistry* 28, 2144–2153.
- Samarasinghe, S. D., Campbell, D. M., Jonas, A. & Jonas, J. (1992) High-resolution NMR study of pressure-induced unfolding of lysozyme, *Biochemistry* 31, 7773–7778.
- Sarvazyan, A. (1991) Ultrasonic velocimetry of biological compounds, *Annu. Rev. Biophys. Biophys. Chem.* 20, 321–342.
- Scarlata, S. F., Ropp, T. & Royer, C. A. (1989) Histone subunit interactions as investigated by high pressure, *Biochemistry* 28, 6637–6641.
- Schade, B. C., Lüdemann, H.-D., Rudolph, R. & Jaenicke, R. (1980a) Kinetics of reconstitution of porcine muscle LDH after reversible high pressure dissociation, *Biophys. Chem.* 11, 257–263.
- Schade, B. C., Lüdemann, H.-D., Jaenicke, R. (1980b) Reversible high-pressure dissociation of LDH from pig muscle, *Biochemistry* 19, 1121–1126.
- Schmid, G., Lüdemann, H.-D. & Jaenicke, R. (1975) High pressure effects on the activity of glycolytic enzymes, *Biophys. Chem.* 3, 90–98
- Schulz, E., Lüdemann, H.-D. & Jaenicke, R. (1976a). High pressure equilibrium studies on the dissociation-association of *E. coli* ribosomes, *FEBS Lett.* 64, 40–43.
- Schulz, E., Jaenicke, R. & Knoche, W. (1976b) Pressure-jump relaxation studies of the association-dissociation reaction of *E. coli* ribosomes, *Biophys. Chem.* 11, 253–257.
- Schwarz, J. R. & Landau, J. V. (1972) Hydrostatic pressure effects on *E. coli*: site of inhibition of protein synthesis, *J. Bacteriol.* 109, 945–948.
- Seifert, T., Bartholmes, P. & Jaenicke, R. (1982) Reconstitution of the isolated β_2 -subunit of tryptophan synthase from *Escherichia coli* after dissociation induced by high hydrostatic pressure, *Biophys. Chem.* 15, 1–8.
- Seifert, T., Bartholmes, P. & Jaenicke, R. (1984) High-pressure dissociation of the β_2 -dimer of tryptophan synthase from *Escherichia coli* monitored by sucrose gradient centrifugation, *FEBS Lett.* 173, 381–384.
- Seifert, T., Bartholmes, P. & Jaenicke, R. (1985) Influence of cofactor PLP on reversible high-pressure denaturation of isolated β_2 dimer of tryptophan synthase holoenzyme complex from *E. coli*, *Biochemistry* 24, 339–345.
- Silva, J., Villas-Boas, M., Bonafe, C. F. S. & Meirelles, S. C. (1989) Anomalous pressure dissociation of large protein aggregates, *J. Biol. Chem.* 264, 15863–15868.
- Silva, J., Silveira, C. F., Correia, A. & Pontes, L. (1992) Dissociation of a native dimer to a molten globule monomer. Effects of pressure and dilution on the association equilibrium of arc repressor, *J. Mol. Biol.* 223, 545–555.
- Sleigh, M. A. & Macdonald, A. G. (eds) (1972): The effects of pressure on organisms, *Symp. Soc. Exp. Biol.* 26.
- Smith, E. B. (1984) The biological effects of high pressure: underlying principles, *Phil. Trans. R. Soc. Lond. B* 304, 5–16.
- Somero, G. N. (1992) Adaptations to high hydrostatic pressure, *Annu. Rev. Physiol.* 54, 557–577.

- Sonoike, K., Setoyama, T., Kuma, Y. & Kobayashi, S. (1992) High pressure and biotechnology, *Colloq. Insepm* 224, 297–301.
- Spirin, A. S. (1971) On the equilibrium of the association-dissociation reaction of ribosomal subparticles and on the existence of the so-called "60 S intermediate" ("swollen 70 S") during centrifugation of the equilibrium mixture, *FEBS Lett.* 14, 349–353.
- Spitzer, M., Gartig, F. & van Eldik, R. (1988) Compact, transportable, and multipurpose high-pressure unit for UV-VIS spectroscopic measurements at pressures up to 200 MPa, *Rev. Sci. Instrum.* 59, 2092–2093.
- Sturtevant, J. M., Velicelebi, G., Jaenicke, R. & Lauffer, M. A. (1981) Scanning calorimetric investigation of the polymerization of the coat protein of TMV, *Biochemistry* 20, 3792–3800.
- Suzuki, K., Miyosawa, Y. & Suzuki, C. (1963) Protein denaturation by high pressure. Measurements of turbidity of isoelectric ovalbumin and horse serum albumin under high pressure, *Arch. Biochem. Biophys.* 101, 225–228.
- Takahashi, K. (1992) High pressure and biotechnology, *Colloq. Insepm* 224, 303–307.
- Taube, D. J., Projahn, H.-D., van Eldik, R., Magde, D. & Taylor, T. G. (1990) Mechanism of ligand binding to hemes and hemoproteins. A high-pressure study, *J. Am. Chem. Soc.* 112, 6880–6886.
- Thomas, W. E. & Ellar, D. J. (1983) *Bacillus thuringiensis* var. *israelensis* crystal delta-endotoxin: effects on insect and mammalian cells *in vitro* and *in vivo*, *J. Cell Sci.* 60, 181–197.
- Trent, J. D., Chastain, R. A. & Yayanos, A. A. (1984) Possible artefactual basis for apparent bacterial growth at 250°C, *Nature* 307, 737–740.
- Tsou, C.-L. (1986) Location of the active site of some enzymes in limited and flexible molecular regions, *Trends Biochem. Sci.* 11, 427–429.
- Unno, M., Ishimori, K. & Morishima, I. (1990) High-pressure laser photolysis study of hemoproteins. Effects of pressure on carbon monoxide binding dynamics for R- and T-state hemoglobins, *Biochemistry* 29, 10199–10205.
- van Bogelen, R. A. & Neidhardt, F. C. (1990) Ribosomes as sensors of heat and cold shock in *E. coli*, *Proc. Natl Acad. Sci. USA* 87, 5589–5593.
- van Eldik, R., Asano, T. & Le Noble, W. J. (1989) Activation and reaction volumes in solution, *Chem. Rev.* 89, 549–688.
- Visuri, K., Kaipainen, E., Kivimäki, J., Niemi, H., Leisola, M. & Palosaari, S. (1990) A new method for protein crystallization using high pressure, *Bio/technology* 8, 547–549.
- Weber, G. & Drickamer, H. G. (1983) The effect of high pressure upon proteins and other biomolecules, *Q. Rev. Biophys.* 16, 89–112.
- Welch, T. J., Farewell, A., Neidhardt, F. C. & Bartlett, D. H. (1993) Stress response of *E. coli* to elevated hydrostatic pressure, *J. Bacteriol.* 175, 7170–7177.
- White, R. H. (1984) Hydrolytic stability of biomolecules at high temperatures and its implications for life at 250°C, *Nature* 310, 430–432.
- Wu, D. & Federici, B. A. (1993) A 20 kDa protein preserves cell viability and promotes cytA crystal formation during sporulation in *Bacillus thuringiensis*, *J. Bacteriol.* 175, 5276–5280.
- Yayanos, A. A., van Boxtel, R. & Dietz, A. S. (1984) High-pressure-temperature gradient instrument: use for determining the temperature and pressure limits of bacterial growth, *Appl. Environ. Microbiol.* 48, 771–776.
- Yayanos, A. A. (1986) Evolutional and ecological implications of the properties of deep-sea barophilic bacteria, *Proc. Natl Acad. Sci. USA* 83, 9542–9546.
- Yayanos, A. A. & Pollard, E. C. (1969) A study of the effects of hydrostatic pressure on macromolecular synthesis in *E. coli*, *Biophys. J.* 9, 1464–1482.
- Yayanos, A. A. & DeLong, E. F. (1987) in *Current perspectives in high pressure biology* (Jannasch, H. W. et al., eds) pp. 17–32, Academic Press, London.
- Zimmerman, A. M. (ed.) (1970) *High pressure effects on cellular processes*, Academic Press, New York.
- Zipp, A. & Kauzmann, W. (1973) Pressure denaturation of metmyoglobin, *Biochemistry* 12, 4217–4228.
- ZoBell, C. E. & Johnson, F. H. (1949) The influence of hydrostatic pressure on the growth and viability of terrestrial and marine bacteria, *J. Bacteriol.* 57, 179.
- ZoBell, C. E. (1970) in *High pressure effects on cellular processes* (Zimmerman, A. M., ed.) pp. 85–130, Academic Press, New York.