

CHAPTER 1



Why Data Center Efficiency Matters

Data centers are the information factories that shape our modern experience. When we access online information ranging from reading our personal email and the news to engaging in commerce, using social media, and consuming entertainment, we are depending on data centers, which provide the computational backbone for the Internet. They create many of the movies we watch, design the cars we drive, and optimize the airplanes we fly. They are used to make scientific discoveries, to find oil, and to predict the spread of disease. Data centers are at the heart of the digital economy.

In 2010, about 30 million servers were in operation worldwide,¹ and the number has been increasing annually. The growth of the Internet of Things² is expected to increase the number of connected devices to over 25 billion by 2020. Other factors driving growth include the continued “dematerialization” of goods,³ the growth of the worldwide economy,⁴ and the increased expectation that our lives are connected to one another through computing technology.

From the perspective of overall energy use, centralized data center-based computing in modern facilities is highly efficient. Recently Facebook estimated that the energy used to sustain an average account for a month is about equal to the energy used to make a cup of coffee.⁵ eBay’s published data center energy use⁶ shows that the amount of carbon produced per transaction is about 50 times lower than the carbon produced in a short drive to the store to complete the same purchase.⁷ One recent study found that

¹Jonathan G. Koomey, *Growth in Data Center Electricity Use 2005 TO 2010* (Oakland, CA: Analytics Press, 2011), <http://analyticspress.com/datacenters.html>.

²See www.gartner.com/newsroom/id/2636073.

³See <http://gigaom.com/2010/04/29/greennet-the-dematerialization-opportunity/>.

⁴See, for example, John M. Jordan, *Information, Technology and Innovation: Resources for Growth in a Connected World* (New York: Wiley, 2012).

⁵See www.facebook.com/green/app_439663542812831.

⁶See <http://tech.ebay.com/dashboard>.

⁷See www.datacenterknowledge.com/archives/2013/03/12/why-ebays-digital-service-efficiency-changes-the-game/.

online purchasing of music uses 40%–80% less energy than any of multiple methods for delivering music by CD, even though that calculation used an upper bound estimate for the electricity intensity of Internet data transfers.⁸

It's somewhat ironic that a principal driver of efficiency in data centers, namely scale, also attracts the most attention to the energy use by data centers. Large-scale data centers can share more resources; for instance, in the case of $N + 1$ redundancy of critical infrastructure systems such as air handlers or power back-up systems,⁹ the incremental penalty decreases as size, and therefore N , increases. However, because of their scale, data centers also require large amounts of electrical energy to operate. Typical large-scale data centers require tens of megawatts of electrical power—enough power to sustain a small city. It is in part this high localized energy use that attracts attention to data centers—they are large and visible buildings that consume a lot of energy. As a result, they can attract the scrutiny of both social activists,¹⁰ neighbors,¹¹ and legislators.¹²

An Industry's Call to Action

It was the convergence of two unrelated events that brought attention to data center energy use. The first was the growth in scale of data centers and the Internet. By one estimate, the number of adults logging onto the Internet increased by 37% from 2000 to 2004. The other trend was the growth of computing performance primarily through clock speed and efficiencies increases.¹³ The result of both growing numbers of data centers and growing power use by the servers (driven by numbers of servers, only marginally by power use per server) within the data center was explosive growth in the power consumed by the data center. Although overstated, claims of “economic meltdown” of the data center certainly grabbed attention.¹⁴

In response to rising public awareness of data center energy use, Congress commissioned a 2007 analysis of US data center energy consumption.¹⁵ The work, completed in 2007 by Lawrence Berkeley National Laboratory using a “bottoms-up” methodology, estimated that data centers were consuming about 1.5% of US electrical energy. Even more alarming, by 2006, data center energy use had doubled since the year 2000 and was on track to almost double again over the following five years.

⁸Christopher Weber, Jonathan G. Koomey, and Scott Matthews, “The Energy and Climate Change Impacts of Different Music Delivery Methods,” *Journal of Industrial Ecology* 14, no. 5 (October 2010): 754–769, <http://dx.doi.org/10.1111/j.1530-9290.2010.00269.x>.

⁹See www.lifelinedatacenters.com/data-center/ups-configuration-redundancy/.

¹⁰See www.greenbiz.com/blog/2011/12/15/facebook-ends-greenpeace-campaign-major-green-commitments.

¹¹See <http://news.idg.no/cw/art.cfm?id=7C75C477-1A64-67EA-E4F528FE768FA524>.

¹²See www.whitehouse.gov/blog/2014/09/30/better-buildings-challenge-expands-take-data-centers/.

¹³See Jonathan G. Koomey, Stephen Berard, Marla Sanchez, and Henry Wong, “Implications of Historical Trends in the Electrical Efficiency of Computing,” *IEEE Annals of the History of Computing* 33, no. 3 (July–September 2011): 46–54, <http://doi.ieeecomputersociety.org/10.1109/MAHC.2010.28>.

¹⁴Ken Brill, “The Economic Meltdown of Moore’s Law and the Green Data Center,” (2007) www.usenix.org/legacy/event/lisa07/tech/brill_talk.pdf.

¹⁵See www.energystar.gov/index.cfm?c=prod_development.server_efficiency_study.

The report flagged the concern that without concerted effort within the data center industry to improve efficiency, the growth of energy consumption risked becoming unsupportable with implications not only for the industries directly affected, but for the economy itself.

The report highlighted some opportunities to improve efficiency and painted several achievable scenarios. Among areas identified for improvement with the biggest impact were data center infrastructure efficiency and the IT equipment inside the data centers. Although the efficiency of the IT equipment in data centers, and specifically the servers, is the focus of this book, it is worthwhile to discuss some of the progress that has been made in improving the efficiency of the infrastructure of data centers.

Data Center Infrastructure Energy Use

The infrastructure energy use of data centers, meaning the energy used to provide clean, reliable, uninterrupted power to the IT equipment and also to remove the waste heat generated by the equipment, is an important part of the overall energy use by data centers. In many cases, the infrastructure can consume a substantial portion of the overall energy use of the data center. Figure 1-1 shows the power consumption of a data center, divided into infrastructure (of non-IT power) and the IT equipment power consumption. Since non-IT power does not contribute directly to information processing, it is considered to contribute to the inefficiency of the data center.

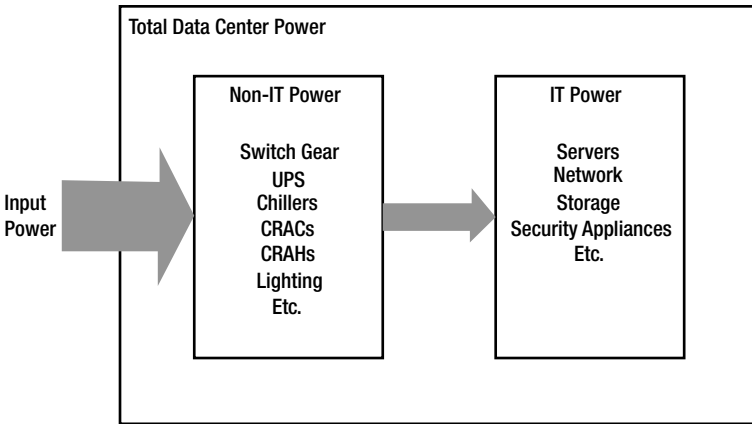

Figure 1-1. The power consumption of a data center

Since the infrastructure exists only to provide support to the IT equipment by maintaining acceptable environmental factors and ensuring clean uninterrupted power delivery, it is considered to be an overhead power usage. On the other hand, the IT equipment is contributing directly to the information processing, and hence is directly related to the efficiency of the data center. This is illustrated schematically in Figure 1-1.

The accepted metric for infrastructure efficiency is the power usage effectiveness (PUE), defined as the ratio of the total energy use by the data center to that of the energy used by the IT equipment.

$$PUE = \frac{\text{Total Data Center Energy Use}}{\text{IT Equipment Energy Use}}$$

Typical enterprise data centers that were designed to now outdated computer room building standards typically would have had a PUE in the range of two to three.¹⁶ That means that for one watt of power used to run the computer, one to two watts of power are used to supply power and provide cooling for the IT equipment. By modern standards, this is highly inefficient. Figure 1-2 illustrates the inverse relationship between data center infrastructure and PUE. For PUE = 2.0, 50% of the power in the data center is used for non-computational purposes. Some highly inefficient data centers can operate at a PUE > 3. As PUE increases above 2.0, over 50% of the data center power is used for heating, cooling, and power conditioning.

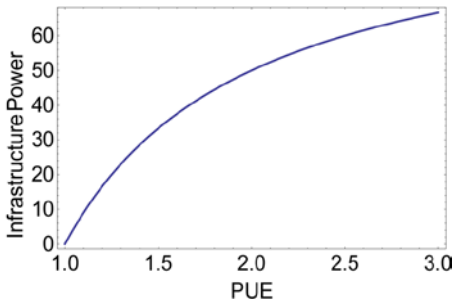

Figure 1-2. The fraction of total data center power used by data center infrastructure as a function of the PUE

Through work done by industry groups like the Green Grid,¹⁷ standard methods to improve infrastructure efficiency have been defined and implemented across the industry. These have resulted in dramatic improvements in the PUE values of state-of-the-art data centers.

A commonly discussed potential weakness of PUE as a metric of data center efficiency is that the very inefficiencies PUE addresses, those of moving air for cooling and conditioning electrical power for delivery, also exist within the server (and thus the IT equipment) itself. Although this is true, the incentive to improve the server by optimizing its energy efficiency lies with the system manufacturer (as will be discussed later in this chapter). PUE provides a metric the designer and operator of the data center facility can use to optimize what is within their control. It is for this reason PUE has been such a successful driver of overall data center efficiency.

¹⁶Victor Avelar, Dan Azevedo, Alan French, eds., “PUE: A Comprehensive Examination of the Metric,” White Paper #49 (2013), www.thegreengrid.org/~media/WhitePapers/WP49-PUE%20A%20Comprehensive%20Examination%20of%20the%20Metric_v6.pdf?lang=en

¹⁷See www.thegreengrid.org/.

Purpose-built mega data centers—like those of Yahoo!, Facebook, and Google—are heavily reliant upon free-air cooling.¹⁸ Typical PUE values in these data centers are about 1.1, meaning of the energy being consumed by the data center, only 10% is being used for non-compute-related tasks. Other, more conventional recently constructed data centers have PUE values near 1.4, meaning about 40% of the energy used by the data center goes to support infrastructure. The reasons these values are higher than the purpose-built mega data centers has to do with specific architectural choices, such as cooling design, as well as requirements for equipment redundancy to meet business-specific resiliency goals.

Although new data center construction typically follows industry best practices for efficient design, improving the efficiency of older, legacy data centers remains a persistent problem. There are several root causes of this. One of these is the rapid evolution of data center technology. For instance, as recently as 2011, ASHRAE approved new building standards that encourage higher operating temperatures in many types of data center.¹⁹ Typically higher operating temperatures have been reported to reduce infrastructure energy use by up to 4% per degree Celsius,²⁰ a substantial savings.²¹

Data centers have been operated between 68 and 72 F, mostly for historical reasons. Cooling requirements in older IT equipment and mainframe computers were less well understood and placed heavy reliance on room cooling because of their scale and size.²² A room-sized computer demands room sized cooling. With the migration toward the current generation of servers, the cooling requirements of the servers have changed, but room specifications have been slow to follow.

Although the higher temperature set point can be adjusted in older buildings, air flow management systems may not be designed or optimized to mitigate localized hot spots in the data center. Unless hot spots are carefully managed, this can lead to increased risk for service availability unless the architecture is substantially changed. Since data center buildings are typically depreciated on a 10- to 20-year schedule, it's not entirely surprising that the timescale for the majority of data centers to catch up with current best practices, let alone match future advances, is on the order of years. At this point, much of the technical innovation for improved data center infrastructure is completed or known, and it is simply a matter of time for current practice to catch up with best practices.

Energy Proportional Server Efficiency

Nearly simultaneously with the report to the US Congress on data center energy consumption, an influential paper published by Luiz André Barroso and Urs Hölzle of Google²³ introduced the concept of energy proportional computing. Computing efficiency depends on both the computational work output of the server as well as the energy consumed by the server. The key insight of the energy proportional model was

¹⁸See www.google.com/green/efficiency/datacenters.

¹⁹*Thermal Guidelines for Data Processing Environments*, 3rd ed. (ASHRAE, 2012).

²⁰See www.datacenterknowledge.com/archives/2007/09/24/data-center-cooling-set-points-debated/.

²¹More careful studies of this savings appear to be warranted.

²²See www.intel.com/content/www/us/en/data-center-efficiency/efficient-datacenter-high-ambient-temperature-operation-brief.html.

²³See www.barroso.org/publications/ieee_computer07.pdf.

the realization that bringing server efficiency closer to the theoretical maximum at all workload conditions would improve overall data center efficiency. By ensuring server energy use scaled proportionally to workload, the efficiency of the servers is optimized over a wider range of utilization, as shown in Figure 1-3. The figure on the left shows the power consumption of a server (ca. 2006) whose idle power is 70% of the peak power. Because power consumption does not scale with workload, the efficiency is far below peak at most operating conditions. The figure on the right shows a server with idle power which is 20% of peak. In this case the efficiency is much higher at all utilization points.

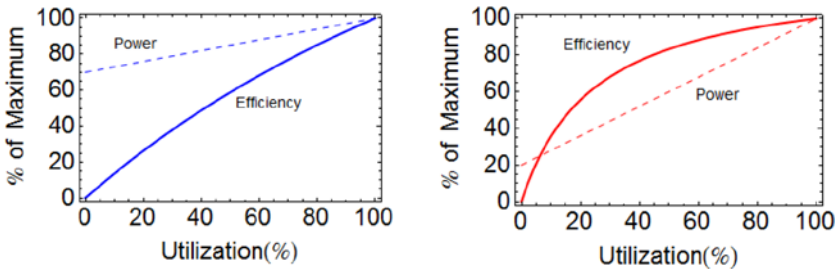

Figure 1-3. *The power consumption and efficiency of two model servers*

Most servers in 2007 consumed almost the same power at 0% utilization (i.e., doing no computations) as they consumed at 100% utilization (i.e., doing the maximum workload or computations per second). For instance, one of the earliest systems reported on the SPECpower benchmark had an idle power of approximately 70% of its peak power.²⁴ This is of concern because, in this case, the power consumption is not proportional to workload; efficiency can be far below the peak efficiency of the server. Indeed, servers often spend much of the time at low utilization. “Energy proportional” scaling of energy use ensures that these servers will operate at high energy efficiency even at lower workload utilization.

Regulatory Environment

A significant outcome of the report to Congress was a focused effort by the Environmental Protection Agency’s Energy Star program to create a standard for energy efficiency.²⁵ Since, at the time, the art of understanding and measuring server efficiency was nascent, initial efforts focused on measuring server idle power. As discussed earlier, idle power can be a good proxy for energy proportionality so long as server performance is also taken into account.

²⁴See http://spec.org/power_ssj2008/results/res2007q4/power_ssj2008-20071129-00017.html.

²⁵See www.energystar.gov/index.cfm?c=prod_development.server_efficiency_study.

It's a common pitfall to equate energy efficiency uniquely with low power. Server idle power, while correlating in some cases to higher efficiency servers, cannot by itself be counted on as a reliable indicator of efficiency. The reason for this is that efficiency correlates to both server energy use and server performance. A computer with low performance will take relatively longer to complete a given amount of work, which can offset any benefits of reduced power.

The current Energy Star standard focuses broadly on energy efficiency, including efficient power supplies, capability to measure and monitor power usage, efficient components, and advanced power management features.²⁶

In addition to the United States, several other countries have taken steps to encourage or even require certain levels of energy efficiency in servers. Among these are the European Union,²⁷ Australia,²⁸ and China. In some cases, energy efficiency restrictions are required due to a lack of necessary electrical grid capacity, whereas with other cases, the standards fit with a framework of reducing carbon footprint.²⁹

A summary of international regulatory implications for server design is shown in Figure 1-4. Although server idle power is a common focus, approaches differ depending on location. This can be problematic since requirements for one (e.g., overall energy consumption) may not be consistent with another (e.g., computing energy efficiency). Server energy efficiency standards and regulations can focus on different aspects of energy efficiency. The Energy Star program focuses on idle power and component efficiency. It is planning to shift toward measures of energy efficiency.

	United States	Europe	China	Australia
Idle Power	<input checked="" type="checkbox"/>	<input checked="" type="checkbox"/>	<input checked="" type="checkbox"/>	<input checked="" type="checkbox"/>
Component Efficiency	<input checked="" type="checkbox"/>			
Energy Use		<input checked="" type="checkbox"/>	Under consideration	Under consideration
Computing Efficiency	In Development	Under consideration	Under consideration	

Figure 1-4. Server energy efficiency standards and regulations

²⁶See www.energystar.gov/products/specs/enterprise_servers_specification_version_2_0_pd.

²⁷See www.powerint.com/en/green-room/agencies/ec-eup-eco-directive.

²⁸See www.energyrating.gov.au/wp-content/uploads/Energy_Rating_Documents/Product_Profiles/Other/Data_Centres/200905-data-centre-efficiency.pdf.

²⁹See www.digitaleurope.org/DocumentDownload.aspx?Command=Core_Download&EntryId=109.

Efficient power supplies are important for overall server efficiency since any losses in the power supply are overhead for any energy uses ultimately for computation. In the 2006 timeframe, power supplies had efficiencies that were as low as 50%.³⁰ Low-efficiency power supplies are cheap to produce, and since customers didn't demand higher efficiency, there was no incentive by the server manufacturer to improve efficiency. But the opportunity is enormous. With the adoption of 80 Plus power supply efficiency guidelines by the EPA for Energy Star in 2007, power supply efficiency rapidly improved. Current power supplies, to be Energy Star-compliant, are required to have efficiencies of 89% at 50% load and a power factor of 0.9. Comparing this to an efficiency of 50%, the power consumption of a server would be reduced 35% for a fixed load.

Measuring Energy Efficiency

It is a common pitfall to associate energy efficiency with low power. Efficiency generally associates a level of output for an amount of input. In the case of computing, the output associated with efficiency measurements is the number of computational cycles completed. Therefore, although low power can definitely contribute to energy efficiency, it is insufficient without adequate performance.

Several metrics are for measuring energy efficiency of servers, but two of the most common are SPECpower_ssj2008 and HPC Linpack. SPECpower was developed by the Standard Performance Evaluation Corporation (SPEC) in 2008 for the express purpose of measuring server energy efficiency. Linpack is a high-performance computing benchmark made up of a collection of Fortran subroutines.³¹ It is used as a measure of energy efficiency on the Green500³² listing of supercomputing energy efficiency.

SPECpower

SPECpower measures the efficiency of a single server using a graduated workload. The workload is graduated in increments of 10% of a measured maximum or 100% server workload performance. SPECpower is based on server-side Java, which has the advantage that measurements can be implemented with a single client set-up. Thus it is economical to operate.

An example output of published SPECpower measurement is shown in Figure 1-5.³³ Performance to power ratios are measured at an established set of points. The quantity

$$\sum ssj_ops / \sum power$$

is an accepted indicator of overall system energy efficiency. As of this writing (March 2015), measurement of over 480 systems have been published. The utility of published SPECpower data is very high since it separates the assessment of power and performance across what is all the "load line" from 0 to 100% of maximum workload.

³⁰See http://en.wikipedia.org/wiki/80_Plus.

³¹See www.top500.org/project/linpack/.

³²See www.green500.org/.

³³See http://spec.org/power_ssj2008/results/res2013q4/power_ssj2008-20131001-00642.html.

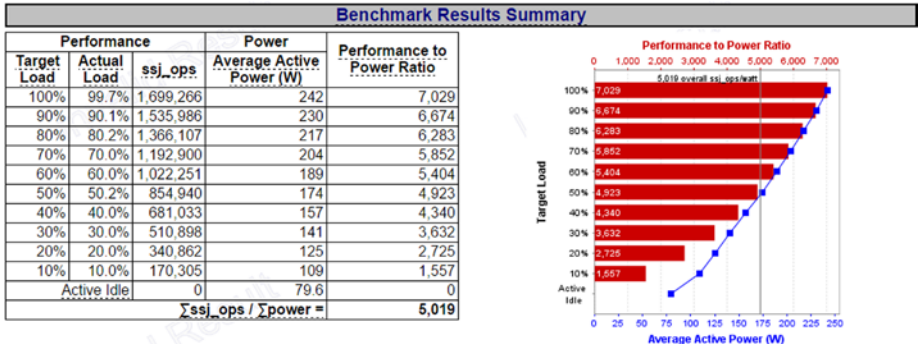

Figure 1-5. A sample of a SPECpower published result. The table emphasizes both workload performance and energy efficiency

The data published for SPECpower has shown a strong trend of improvement in the energy efficiency of servers. Although SPECpower is not measured for a large variety of servers, it is representative of the capability of servers whose power management is properly configured. Figure 1-6 shows a plot of the energy efficiency of all dual socket servers with Intel Xeon processors as a function of the “hardware available” data for the system. The data show that the energy efficiency of the servers are increasing exponentially (note the logarithmic scale), doubling approximately every 1.6 years. That means that in the 7 years since 2007 when the benchmark was published, energy efficiency has increase by about a factor of 20.

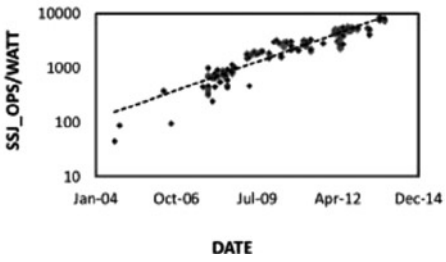

Figure 1-6. Dual-socket server energy efficiency, as measured by SPECpower, Intel-Xeon based systems versus their “hardware available” date. Note the logarithmic scale, indicating an exponential trend

What is less obvious is what the contributions are to the increase in energy efficiency. Since energy efficiency is a ratio of performance to power usage, the increase can be attributed to either a performance increase or a power decrease. It turns out both are responsible in the case of SPECpower.

To understand this, we can look at the details of the SPECpower data shown in Figure 1-7. The figure shows the trend of both the ratio of idle to maximum power and the performance for all published two-socket Intel Xeon-based servers at SPEC.org for the SPECpower_ssj2008 benchmark. Both trends emphasize the growing importance of energy-proportional behavior of servers in improving energy efficiency. The ratio of idle to max power is a metric for the proportionality of the server. SPECpower reports carry a wealth of information about the server, including CPU and memory configuration.

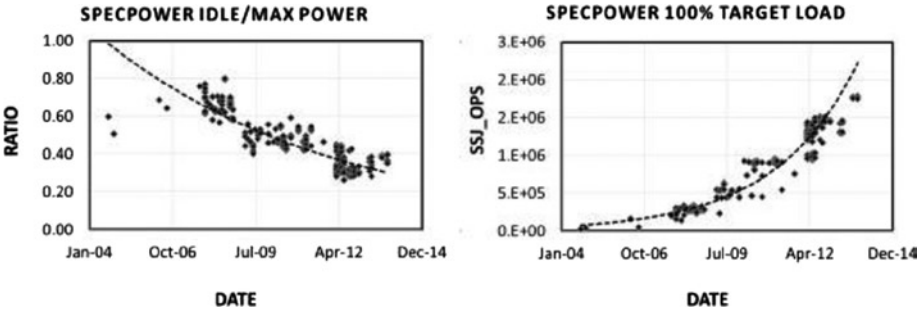

Figure 1-7. Trend of both the ratio of idle to maximum power and the performance for all published two-socket Intel Xeon-based servers

The historical trend of energy proportional efficiency can be visualized in another way—by examining the “load line” of respective generations of servers as measured by SPECpower. The load line is simply a graph of the server power versus the absolute workload. From the graph, the power, efficiency, and performance of the server can be deduced. Figure 1-8 shows the selected graphs from platforms built from specific generations of processor families. The horizontal axis measures computations work up to a measured system performance limit. The vertical axis measures system power. Over time, according to this specific benchmark, system performance has increased while system power has decreased.

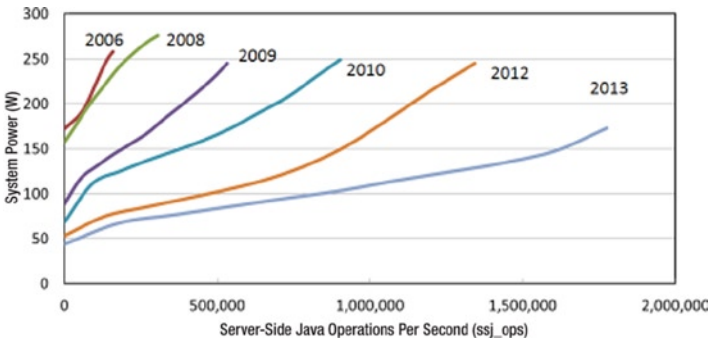

Figure 1-8. The “load lines” of several generations of two socket servers as measured by SPECpower_ssj2008

How do you read the graph? System workload is plotted along the x-axis (from active idle to a load point of 100% system capacity) and system power is plotted along the y-axis. The curves for each server follow an intuitive progression; as system workload increases, power usage increases. The degree of that increase is related to the proportionality of the system. Note that higher performance is to the right, lower power is down, and therefore higher efficiency is to the lower right. Note also, work output capability is measured in *server-side Java operations per second* or *ssj_ops*, which is a measure of system performance.

What's first evident from the graph is the higher peak performance in each successive generation. There is a gain in "peak" energy efficiency inherent with performance increases in the systems (more "work"). This is the progression known colloquially as Moore's Law. Note that the peak power of these systems is relatively constant at about 250 watts.

However, the graph reveals an additional progression toward lower power at low utilization, that is, toward delivering even higher gains in energy efficiency at actual data center workloads via "energy proportionality." Assuming each system is run at the mid-load point, the average power dropped from a little over 200 watts in 2006 to about 120 watts in 2012. That's a net power reduction of about 40% and, assuming \$0.10/kWh energy costs and a PUE of 2.0, an operational cost saving of about \$150/year. In addition, the work output capability (measured in *ssj_ops*) at that load point increases over a factor of 10.

The families of curves reveal several interesting trends. The first notable trend is the steady decrease in idle power of the systems. You'll notice the curves fall into sets of pairs. At a high level, this is because managing idle power of a server is primarily related to the microarchitecture. Indeed optimizing the features of the microarchitecture to achieve the right balance of power and performance capability is a main subject of this book.

You'll also note the steady increase in performance with each generation. These performance increases have two origins. In the years 2006, 2009, and 2012, new microarchitectures were introduced. In intervening years new process technologies were introduced (Intel's "tick-tock" model³⁴) giving rise to lower power and also substantially increased performance. Table 1-1 lists the evolution of energy-efficient servers derived from both process technology and microarchitectural revolutions. Development of new architecture and new silicon process technologies represent huge investments in capital and engineering. The highlights emphasize the tick-tock development cycles of staggered process technology and architecture.

³⁴See www.intel.com/content/www/us/en/silicon-innovations/intel-tick-tock-model-general.html.

Table 1-1. *The Evolution of Energy-Efficient Servers*

Year	Microarchitecture Family	Process Technology	Processor Family
2006	Core	45 nm	Xeon 5100
2008	Core	32 nm	Xeon 5400
2009	Nehalem	32 nm	Xeon 5500
2010	Nehalem	22 nm	Xeon 5600
2012	Sandy Bridge	22 nm	Xeon E5
2014	Haswell	14 nm	Xeon E5 v3

It is also instructive to look at the reduction in the energy per operation as deduced from the SPECpower data. The energy reduction is easily visualized in Figure 1-9 as the area of the rectangle defined by the average power and the time per `ssj_op`. Each data point is labeled for correspondence to Figure 1-8. The time per `ssj_op` is calculated as the reciprocal of measured `ssj_ops` at 10% utilization on the SPECpower trend curves in Figure 1-8.

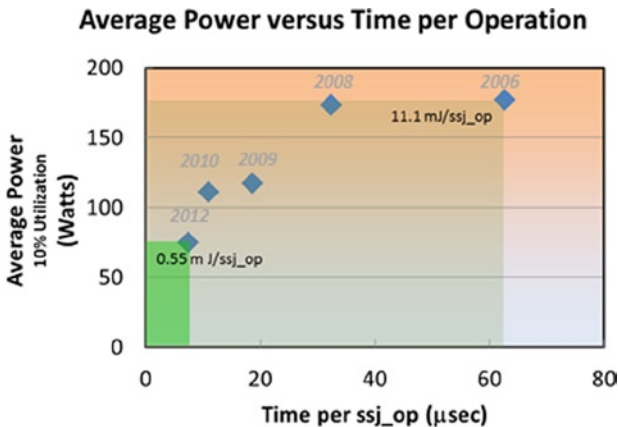

Analysis of data from SPEC.org

Figure 1-9. *A representation of the energy per `ssj_op` as measured by SPECpower`ssj_2008` showing the role of both reducing the time and the power consumed while doing a computation. Both have been important in reducing overall energy consumption*

What is interesting is the stair-step pattern shown in Figure 1-10—the trend of the energy per operation as a function of time shows a 41% per year reduction. From 2006 to 2008 we moved from 65 nm to 45 nm silicon technology, and from 2009 to 2010 from 45 nm to 32 nm silicon technology. In each case, the time to complete an operation decreased by about half. Complementing that, from 2008 to 2009, and from 2010 to 2012, were significant microarchitecture changes. These resulted in time reductions associated with performance gains, but also significant power reductions. Overall, both power and time reductions contributed to the gains in efficiency.

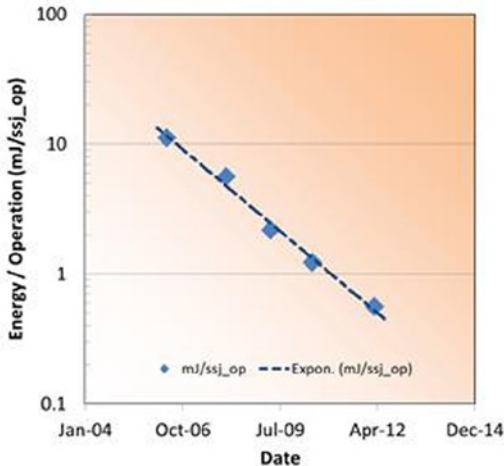

Figure 1-10. The SPECpower_{ssj_2008} trend of the energy per operation as a function of time shows an exponential trend that is consistent with an efficiency-doubling time of 0.9 years. This is much faster than the 1.5 years reported by Koomey, owing to additional efficiency gains from energy proportionality

Plotting the data as a time series versus the “system available” date from the SPECpower data shows the expected exponential trend. The fit parameters equate to a 41% per year reduction in the energy per operation and about a factor of 20 over the range shown. Putting the energy needed for computation into perspective, 0.5 milli-Joules is the energy needed to light a 100-watt bulb for about 5 microseconds.

The performance and efficiency gains from microarchitecture also play a strong role in other benchmarks, as the next discussion of high performance computing will show.

High Performance Computing Efficiency

High Performance Computing (HPC) is another area where a trend of computing efficiency has been established by well-accepted methods. The Green500 list has, since 2007, published a semi-annual list of the top energy-efficient super computers in the world.³⁵ The Green500 shares the same workload as the Top500 supercomputing performance list.³⁶ Both are based on HP Linpack, which derives from a collection of Fortran linear algebra routines written in Fortran in the 1970s. Excellent source material on the Linkpack routines can be found online.³⁷

Alternative benchmarks have appeared, such as the Graph500,³⁸ which are more relevant to measuring performance of supercomputers running data-intensive applications. Arguably with the growth of “big data” applications to continue into the future, these kinds of benchmarks will be relevant to a broader range of supercomputing applications. However, at this writing, the alternatives are just getting going and have not yet gained the same recognition as have the Top500 and Green500 lists. As a result, this discussion will focus on the historical trends of the Green500 and Top500 lists.

At the scale of supercomputers today, performance leadership is practically inseparable from efficiency leadership due to the practical constraint of power. The power consumption of the largest supercomputers in the world is now between 10 and 20 megawatts. Although these limits are not written in stone, at an estimated infrastructure cost of about \$10 per watt, the cost of expanding beyond those limits is prohibitive except for the largest governmental and private agencies. With the expanded role of supercomputing in everything from office scale DNA decoding to field-based geophysics, the need for higher performance in fixed-power environments is increasing.³⁹

Since both performance and efficiency are important to supercomputing leadership, it is convenient to look at both the efficiency and performance of supercomputers simultaneously. The Exascalar method does exactly this, plotting the points from the Green500 list by their performance and efficiency.⁴⁰ Figure 1-11 shows the efficiency and performance of the computers in the Top500 supercomputer list since 2007. The historical trend line reveals that the performance gains of the top systems have been due to both efficiency gains and increases in power. Exascalar measures progress of supercomputing leadership toward a goal of 10^{18} flops (an *Exaflop*) in a power envelope of 20 megawatts. As is evident in Figure 1-11, the points fall roughly into a triangular shape with a taxonomy that reflects the state of the art in computing performance and efficiency and also cost.

³⁵See www.green500.org/.

³⁶See www.top500.org/.

³⁷See www.top500.org/project/linpack/.

³⁸See www.graph500.org/.

³⁹See www.intel.com/content/www/us/en/research/tomorrow-project/intel-labs-dna-sequencing-and-bio-chem-sensing-video.html.

⁴⁰See www.datacenterknowledge.com/archives/2012/07/10/june-2012-exascalar-efficiency-dominates-hpc/.

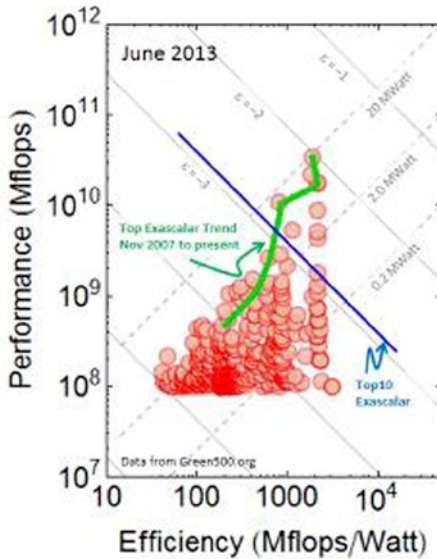

Figure 1-11. The Exascalar plot of the June 2013 Green500 list

The Exascalar values in this graph are computed from the formula where both efficiency and performance are normalized to the goal of one Exaflop in a 20 megawatt power envelope.

$$\varepsilon = \frac{1}{\sqrt{2}} \text{Log} \left(\frac{\text{Efficiency}}{10^{18} \text{ Flops}/20 \text{ MWatt}} \frac{\text{Performance}}{10^{18} \text{ Flops}} \right)$$

The factor of $\sqrt{2}$ ensures consistency with an earlier (but more complex and less generalizable) formulation of Exascalar.⁴¹

The earlier-mentioned triangular shape comes about because of the constraints of power in general application. Although the trend in increased power is evident from the trend line of the top Exascalar systems, that increase, about a factor to ten, also increases the installation costs by roughly a factor of ten and therefore represents a major barrier for a majority of adopters.⁴² Another point to note in the graph is that systems in the lower left-hand corner consume almost 100 times the power of the systems in the lower right-hand corner of the triangle, but deliver the same performance. This represents a potentially very large difference in total cost of ownership (TCO).

⁴¹Balaji Subramaniam, Winston Saunders, Tom Scogland, Wu-chun Feng, “Trends in Energy-Efficient Computing: A Perspective from the Green500,” Proceedings of the 4th International Green Computing Conference (Arlington, VA, June 2013).

⁴²www.datacenterknowledge.com/archives/2013/01/28/the-taxonomy-of-exascalar/.

The trend of the Exascalator can also be plotted as a time series as shown in Figure 1-12. The top Exascalator system trend intersects the Exaflop equivalent of Exascalator ($\epsilon = 0$) some time in the year 2019. The median Exascalator trend is increasing at a slower rate, which can be accounted for by the slower increase in power (but similar gains in efficiency) of the general population. The differential between the top and median Exascalator growth is accounted for by the increased power levels of the top systems.

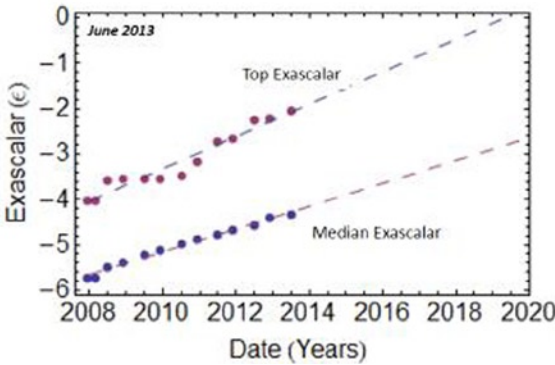

Figure 1-12. The trend of the top and median Exascalator as a function of publication date

Comparing the SPEC Powerssj_2008 results with the Exascalator results shows the challenge of trending energy use and efficiency with benchmarks. In the case of SPEC Powerssj_2008, the overall system power has decreased over time to benefit efficiency, while in the case of the HPC benchmarks, overall system power has increased over time to achieve higher performance.

Energy Efficiency and Cost

Energy efficiency is a highly desirable characteristic in data centers, but the overall goal of a data center is to meet the computational needs within both physical and financial constraints of the organization. These constraints are usually captured in a TCO model, which takes into account both capital and operational costs of the data center (see Table 1-2).

TCO generally depends very strongly on the specific applications or intended use of the data center. This is a reflection of the wide range of applications for data centers. For instance, in some locations, the high costs of energy may favor the choice of a particular power envelope for the servers or, in some other cases, software licensing costs may strongly influence hardware choices.

However, outside these special cases, some general observations can be made about TCO.

Costs fall into two categories: capital costs and ongoing operational costs. The capital costs are associated with the the facility of the data center itself as well as the servers and other IT gear required to make the data center operate. Important operational costs include electricity, water, maintenance, and so on. Other factors, such as expected depreciation for both the facility and IT hardware, may also have a pronounced effect on the outcome of the model.

Many TCO models are available online. Some are made available for cost; some are available as a service.⁴³ These models have varying degrees of sophistication depending on the desired fidelity and tolerance for error.

Table 1-2 lists the ranges of parameters for a TCO model. The operational server energy cost includes overhead of PUE = 2.0. In both cases, the energy cost to run the servers in a data center is comparable to the facility cost itself.

Table 1-2. *Ranges of Parameters for a TCO Model*

	Low Cost Range (U.S.)	High Cost Range (U.S.)
Facility capital cost per watt	\$8–\$12	\$20–\$40
Facility capital depreciation	10 years	20 years
Facility capital cost/watt/year	\$0.80–\$1.20	\$1.0–\$2.0
Electricity cost per watt	\$0.03/kWh	\$0.15/kWh
PUE	1.2	2.0
Operational server energy cost/watt/year	\$0.31	\$2.62

Since the subject of this book is primarily server energy cost, a simplified model is shown in the table emphasizing the comparison of the facility cost with the energy needed to run the servers. The low cost range data center might correspond to an efficient cloud data center in a region selected for a mild climate and low-cost electricity. The high cost range might correspond to a highly secure and redundant data center near a major metropolitan area. In both cases, it is apparent that the energy costs of the data center are comparable to the facility capital cost.

⁴³Vasileios Kontorinis, et al., “Managing Distributed UPS Energy for Effective Power Capping in Data Centers,” *International Symposium on Computer Architecture, ISCA* (2012), <http://cseweb.ucsd.edu/~tullsen/DCmodeling.html>.

More sophisticated models take into account much more detailed analysis of individual data center costs, building upon and also substantiating the simpler analysis in Table 1-2.⁴⁴ In the model shown in Figure 1-13, power and cooling infrastructure costs are about equivalent to the utility energy costs. Although energy costs and facility capital costs represent about equal parts of the TCO, server depreciation is also an important contributor.

TCO / server breakdown NO Oversubscription

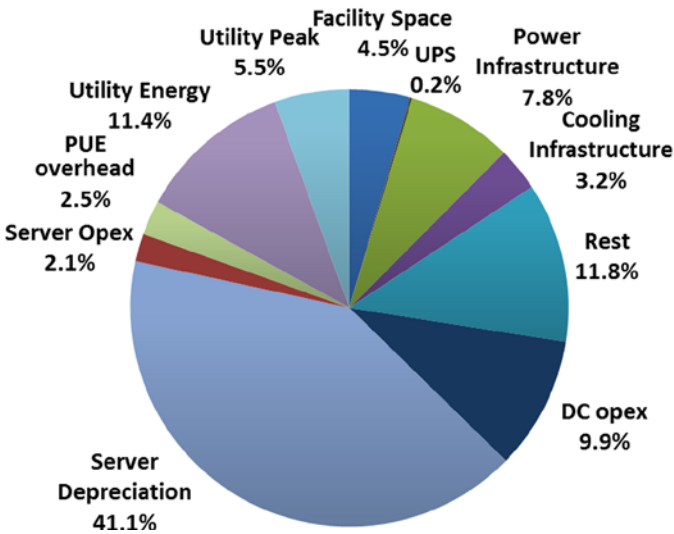

Figure 1-13. An example of a breakdown of data center TCO

However, traditional data center TCO models do not consider the cost of work output from the data center per se; they simply treat the servers as power-consuming units without regard for energy efficiency or performance of their computing capability. What is astonishing is that from a work output standpoint, the most wasteful energy consumers in data centers (even low PUE data centers) can be inefficient servers.

To illustrate this point, consider Figure 1-14, taken from an actual assessment of a Fortune100 company’s data center. The analysis consisted of looking at the age distribution of the servers and then assessing, based on their configuration, energy consumption and finally their work output (or performance) capability. Although older servers were only 32% of the population, they consumed the majority of energy and only contributed a small fraction of the total computational output of the data center.

⁴⁴Ibid.

Since server efficiency doubles approximately every one to two years (depending on application and the specific metric used), older servers are far less efficient and constitute a larger fraction of energy use for a lower fraction of computing cycles.

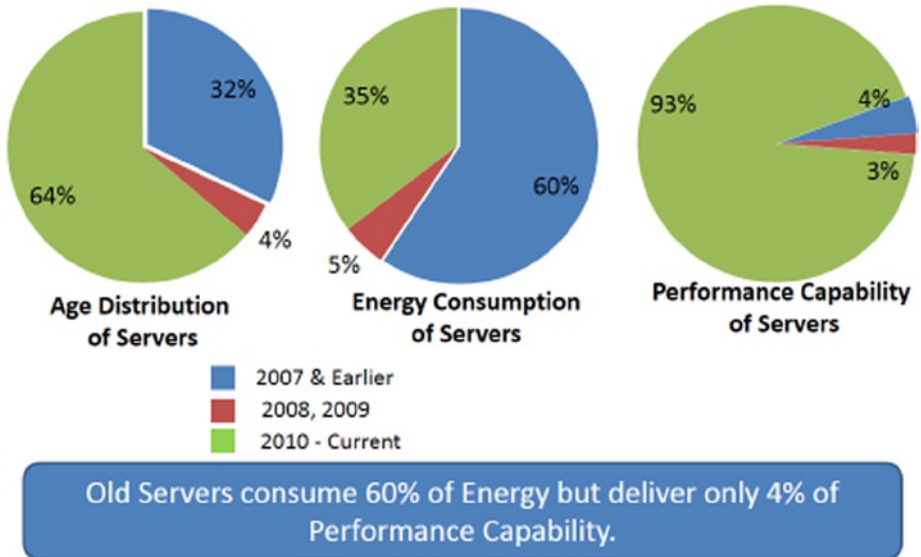

Figure 1-14. Data from a walkthrough inventory of a Fortune 100 company showing the energy consumption and age distribution of servers

In this particular data center, servers older than 2007 consume 60% of the energy but contribute only an estimated 4% of the compute capability. Although this may seem counterintuitive, consider the argument from the perspective of Moore's Law; if the performance doubles approximately every two years, servers from 2006 do approximately 1/8th the computational work of servers dating from 2012, when the data was collected. Given the power consumption data presented earlier, it is also feasible that the energy consumption would decrease in newer servers, dependent on configuration.

Therefore, in data centers concerned not just about energy usage, but actual computational work, the energy efficiency and performance of the servers are important overall considerations. Detailed measurements on either actual or representative workloads are generally needed to achieve the highest levels of overall workload efficiency. The remainder of this book focuses specifically on the optimizations that can take place not only at the server level but also the data center level to optimize energy use and computational output of what may amount to a multi-million or even billion dollar investment.

Summary

In this chapter we have reviewed the performance and efficiency trends of data centers and have shown that the servers can contribute to the overall energy use in data centers, especially in cases where the efficiency of the infrastructure has been optimized.

We've compared the performance and efficiency trends of servers based on both the SPECpowersj_2008 and the derived Exascale benchmarks. In both cases, the efficiency of servers has improved exponentially over time, though with differing trends, depending on the specific workload.

In subsequent chapters, we will show how the efficiency of servers can be optimized for specific workloads, thus enabling users to tailor their server configurations for optimum performance and efficiency. In the final chapter of the book, we will tie these results back to TCO and show how performance, power, and cost tie together into an overall framework of datacenter TCO.