

# Advanced Technologies in Sialic Acid and Sialoglycoconjugate Analysis

Ken Kitajima, Nissi Varki, and Chihiro Sato

**Abstract** Although the structural diversity of sialic acid (Sia) is rapidly expanding, understanding of its biological significance has lagged behind. Advanced technologies to detect and probe diverse structures of Sia are absolutely necessary not only to understand further biological significance but also to pursue medicinal and industrial applications. Here we describe analytical methods for detection of Sia that have recently been developed or improved, with a special focus on 9-*O*-acetylated *N*-acetylneuraminic acid (Neu5,9Ac), *N*-glycolylneuraminic acid (Neu5Gc), deaminoneuraminic acid (Kdn), *O*-sulfated Sia (SiaS), and di-, oligo-, and polysialic acid (diSia/oligoSia/polySia) in glycoproteins and glycolipids. Much more attention has been paid to these Sia and sialoglycoconjugates during the last decade, in terms of regulation of the immune system, neural development and function, tumorigenesis, and aging.

**Keywords** Chemical analysis · Deaminoneuraminic acid · Disialic acid · DMB derivatization · Immunochemical analysis · Immunohistochemistry · *N*-Glycolylneuraminic acid · *O*-Acetylated sialic acid · Oligosialic acid · *O*-Sulfated sialic acid · Polysialic acid

## Contents

1	Introduction .....	76
1.1	<i>O</i> -Acetylated Sialic Acids (SiaAc) .....	77
1.2	<i>N</i> -Glycolylneuraminic Acid (Neu5Gc) .....	78
1.3	Deaminoneuraminic Acid (Kdn) .....	78
1.4	<i>O</i> -Sulfated Sialic Acids (SiaS) .....	78
1.5	Di-, Oligo-, and Polysialic Acids (diSia/oligoSia/polySia) .....	79

---

K. Kitajima (✉) and C. Sato  
Bioscience and Biotechnology Center, Nagoya University, Nagoya, Japan  
e-mail: [kitajima@agr.nagoya-u.ac.jp](mailto:kitajima@agr.nagoya-u.ac.jp)

N. Varki  
Department of Pathology, University of California, San Diego, CA, USA

2	Chemical Analyses of Sialic Acid and Sialoglycoconjugates .....	80
2.1	Detection of Modified Sialic Acids .....	80
2.2	Detection of Oligo/Polysialic Acids .....	82
3	Immunochemical Analyses of Sialic Acid and Sialoglycoconjugates .....	86
3.1	Immunochemical Detection of Kdn and <i>O</i> -Sulfated Sialic Acids .....	86
3.2	Immunochemical Detection of Oligo- and Polysialic Acids by Immunoblotting and ELISA .....	87
4	Immunohistochemistry for Specific Sialic Acids .....	90
4.1	Detection of 9- <i>O</i> -Acetylated Sialic Acids in Mammalian Tissues .....	92
4.2	Detection of Neu5Gc in Human Tissues .....	95
5	Conclusion and Perspectives .....	96
	References .....	97

## 1 Introduction

All cells are covered with glycoproteins and glycolipids, the biosynthesis of which takes place in the endoplasmic reticulum and Golgi compartments, and involves a variety of enzymes. The expression of some of these enzymes has been shown to be important in embryogenesis, cancer, pathogen recognition, and inflammation. *N*- and *O*-glycans and glycosphingolipids are often terminated with sialic acid (Sia), a family of nine carbon carboxylated monosaccharides, with high structural diversity. Sia consists of *N*-acetylneuraminic acid (Neu5Ac), *N*-glycolylneuraminic acid (Neu5Gc), deaminoneuraminic acid (Kdn), and their derivatives with modifications, such as acetylation, lactylation, methylation, and sulfation at the 4, 7, 8, and 9 positions (Fig. 1) [1–3]. These modifications of Sia have been implicated in embryonic development, protection from microbes and viruses, and modulation of complement activation [1, 2].

Sia exists as either free or bound sugar linked to galactose, *N*-acetylgalactosamine, and other sugar residues in various positions. Furthermore, Sia links to Sia itself to form dimeric, oligomeric, and polymeric structures (diSia/oligoSia/polySia). Thus, Sia shows extremely high structural diversity due to monosaccharide species as well as linkage modes. No other monosaccharide exhibits this structural diversity. Although there are some reports showing the biological significance of Neu5Gc and Neu5,9Ac [1, 4–6], for the majority of modified Sia, biological roles have not been well elucidated. For this purpose, specific methods or probes to detect specifically modified Sia are absolutely necessary. In this chapter we summarize current chemical and immunochemical methods to detect modified Sia species, with a special focus on *O*-acetylated Neu5Ac, Neu5Gc, Kdn, *O*-sulfated Sia, as well as diSia, oligoSia, and polySia. Because other chapters in this volume specifically focus on *O*-acetylated Neu5Ac [7], Neu5Gc [8], and polySia [9], we restrict ourselves in this chapter to a brief introduction of the different Sia species.

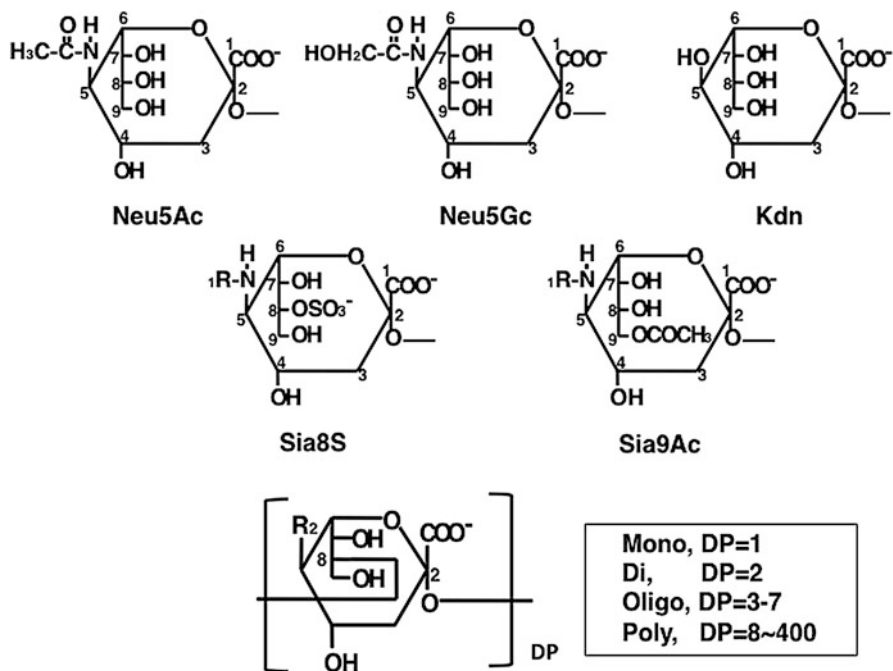

**Fig. 1** Structures of sialic acid and sialoglycans described in this chapter.  $\text{R}_1$ :  $\text{CH}_3\text{CO}-$ , Neu5Ac;  $\text{HOCH}_2\text{CO}-$ , Neu5Gc.  $\text{R}_2$ :  $\text{CH}_3\text{CONH}-$ , Neu5Ac;  $\text{HOCH}_2\text{CONH}-$ , Neu5Gc;  $\text{HO}-$ , Kdn

## 1.1 O-Acetylated Sialic Acids (SiaAc)

The *O*-acetylated Sia (SiaAc) at the 4, 7, 8, and 9 positions frequently occurs in glycoproteins and glycolipids. SiaAc is expressed in cell type-specific and developmental stage-specific manners, and is involved in various biological phenomena, such as immune reactions, virus-cell adhesion, malignancy, and others [1, 10]. Sialate:*O*-acetyl-transferases [1, 11] and sialate:*O*-acetyl-esterases [12–14] are important enzymes for acetylation and deacetylation of Sia. The importance of 9-*O*-acetylated Sia during early development was evidenced by the transgenic expression of Influenza C hemagglutinin esterase in mice, leading to mice deficient in 9-*O*-acetylated Sia [4]. Recent analyses on sialate:*O*-acetyl-esterase deficient mice showed impairment of B cell-related functions that could be related to the inhibitory activity of siglec-2 ([5]; siglecs are discussed by Schwardt et al. [15]).

## 1.2 *N-Glycolylneuraminic Acid (Neu5Gc)*

Neu5Gc is broadly expressed in mammals. Neu5Gc is synthesized by the CMP-Neu5Ac hydroxylase (CMAH), a converting enzyme of CMP-Neu5Ac to CMP-Neu5Gc [16, 17]. Due to a genetic defect in *CMAH*, humans do not express a functional CMAH and thus do not endogenously produce Neu5Gc. However, Neu5Gc can be metabolically incorporated from dietary sources (particularly red meat and milk) into glycoproteins and glycolipids. Human fetuses, tumors, and some normal tissues were shown by mass spectrometry to incorporate Neu5Gc. Moreover, Neu5Gc has been demonstrated to be metabolically incorporated and covalently expressed on cultured human cell surfaces. Metabolically incorporated Neu5Gc is immunogenic in humans [18], and the presence of human anti-Neu5Gc antibodies has been associated with tumor progression [19] and vascular inflammation [20]. For additional details see Shilova et al. [21] and Davies and Varki [8].

## 1.3 *Deaminoneuraminic Acid (Kdn)*

Kdn contains a hydroxyl group at the C-5 position, instead of the acetamide-group in Neu5Ac (Fig. 1). Kdn was discovered in glycoproteins from rainbow trout eggs [22, 23]. In mammalian tissues, Kdn occurs at a very low level and amounts to <1% of total Sia. However, expression of Kdn increases in certain ovarian cancers, and the amount is proportional to the degree of malignancy [24]. Under hypoxic conditions free Kdn increases in mammalian tumor cells. As hypoxia-resistance is a frequent property found in tumors, it is likely that Kdn supports this state of mammalian cells [25]. In rat liver, cytosolic Kdn increases in an age-dependent manner. The level of free Kdn was reported to be high in erythrocytes of the umbilical vein. These findings demonstrate that attention has to be paid to the physiological significance of Kdn in malignancy and in aging [23]. Of interest in this context, Kdn residues, in contrast to Neu5Ac and Neu5Gc, are resistant to known bacterial and mammalian sialidases [22, 23]. In salmonid fish, Kdn caps polySia chains in egg polysialoglycoproteins, thus stopping chain elongation and possibly protecting polySia from bacterial sialidase attacks [22, 23]. Biological roles of Kdn in mammals remain to be elucidated, but increase of the Kdn level in cells and tissues may be a biomarker for some cancers and in aging cells.

## 1.4 *O-Sulfated Sialic Acids (SiaS)*

Sias are sometimes esterified with sulfate group to give *O*-sulfated Sia (SiaS). Methods for the detection of SiaS are not so well developed, and occurrence of SiaS has been only demonstrated in a limited number of animal species so far

[26–34]. In sea urchin, 8-*O*-sulfated Neu5Ac (Neu5Ac8S) and Neu5Gc8S are present in glycolipids [27–29], in glycoproteins from the vitelline layer polysialylated glycoprotein [30], and in the sperm flagellar glycoprotein, flagelliasialin [31, 32]. In mammals, Neu5Ac8S and Neu5Gc8S residues are found in gangliosides from bovine gastric mucosa [33, 34], and Neu5Ac8S was detected in tissues from human, rat, and mouse [35, 36]. The glycoconjugates carrying SiaS in mammals have remained undetermined with the exception of the bovine gastric gangliosides [33, 34]. Similarly, the biological significance of the SiaS in animal tissues is not known. It is interesting, however, that chemically synthesized SiaS-containing compounds have been applied as artificial inhibitors for fertilization [37] and bacterial infections [38], irrespective of the very limited knowledge on the natural occurrence of SiaS. These facts point to the potential importance of the SiaS residues in various biologic processes.

### 1.5 Di-, Oligo-, and Polysialic Acids (diSia/oligoSia/polySia)

In most cases, Sias are present as  $\alpha$ 2,3- or  $\alpha$ 2,6-linked monosialyl residues at the non-reducing terminal positions of glycan chains on glycoproteins and glycolipids. In two cases Sia has been identified as an internal sugar between neutral sugars: Fuc $\alpha$ 1 $\rightarrow$ O<sub>glycolyl</sub>Neu5Gc $\alpha$ 2-4Neu5Ac $\alpha$ 2-6Glc1- in echinoderms [39] and a polymer of  $\rightarrow$ 4Neu5Ac $\alpha$ 2 $\rightarrow$ 6Glc/Gal1 disaccharide in the capsular polysaccharides of *Neisseria meningitidis* serogroups Y and W-135, respectively [40]. Moreover, Sias can be linked to each other to form diSia, oligoSia, and polySia (by definition DP > 8 is termed polySia). First identified in the glycocalyx of neuroinvasive bacteria, polySia has so far been demonstrated to be a posttranslational modification on six glycoproteins, the fish egg polysialoglycoprotein (PSGP), the neural cell adhesion molecule (NCAM), a voltage-gated sodium channel in eel, CD36 in human milk, NRP2 in human lymphocytes, and SynCAM-1 in mouse brain (for recent reviews see [41–43]). Polysialylation occurs in some tumors (probably on NCAM) and is involved in metastasis. By virtue of its net negative charge at physiological pH and exclusive volume, polySia serves as a mediator of ligand–receptor and cell–cell interactions via an anti-adhesive effect [44]. In addition, polySia has been demonstrated to function as a reservoir molecule for BDNF, dopamine, and FGF-2 [41, 43, 45–49] and to be involved in the regulation of ion transport via interactions with channels [32, 50–52]. Compared to what is known about polySia, the information on oligoSia is limited [43, 53, 54]. DiSia and oligoSia are common glyco-epitopes between glycolipids and glycoproteins. The functions of diSia on the glycolipids (GD3 and GT1b) have been well studied, while far less knowledge about the functions of diSia and oligoSia on the glycoproteins has been reported [55–57]. Interestingly, oligoSia and polySia with the degree of polymerization up to 16 have been recently found in glycolipids of sea urchin sperm [58], although their functions remain to be elucidated.

## 2 Chemical Analyses of Sialic Acid and Sialoglycoconjugates

### 2.1 Detection of Modified Sialic Acids

#### 2.1.1 Colorimetric Analyses

To quantitate the amount of Sia at 0.1–100  $\mu\text{g}$ , colorimetric analyses are most common with simple methods, and include the thiobarbituric acid [59, 60] and resorcinol methods [61]. In the resorcinol method, Neu5Ac and Neu5Gc in either free or bound form can be equally detected, while Kdn gives no color. In the thiobarbituric acid, Neu5Ac and Neu5Gc are detected only in free form, while Kdn can be detected in both free and bound forms. To quantitate the amount of Sia below 0.1  $\mu\text{g}$ , a highly sensitive fluorometric high-performance liquid chromatography (HPLC)-based method is usually used. Here we focus on the detailed description of fluorometric HPLC technology.

#### 2.1.2 Fluorometric HPLC Analysis

Fluorometric HPLC analysis is currently the most sensitive and reliable method for quantitative detection of Sia in the pmol range. In this analysis, a free form of various Sia species is labeled with the fluorescent dye 1,2-diamino-4,5-methylene-dioxybenzene (DMB), and fluorometrically analyzed on HPLC [62, 63]. DMB is a reagent which specifically reacts with  $\alpha$ -keto acids, and detects not only Sia but also typical  $\alpha$ -keto acids such as pyruvate and  $\alpha$ -ketoglutarate. Fluorometric HPLC analysis consists of the following steps: step 1, acid hydrolysis of sialoglycoconjugates to release free Sia; step 2, fluorescent labeling of released Sia with DMB; step 3, separation and quantification of DMB-labeled Sia on HPLC.

Fluorometric HPLC analysis involves two acidic conditions. One is a hydrolysis, 0.1 N trifluoroacetic acid at 80°C for 2 h to release free Sia from sialoglycoconjugates at step 1. The second is the DMB labeling which takes place in 0.01 N trifluoroacetic acid at 50°C for 3 h (step 2). Attention must therefore be given to the acid lability of some Sia substituents. No significant degradation of Neu5Ac, Neu5Gc, and Kdn has been reported. For SiaS, the glycosidic bonds of SiaS were completely hydrolyzed under the hydrolysis conditions, while their sulfate esters are hydrolyzed by, at most, 4% [64]. No apparent desulfation occurred under the labeling conditions. The *O*-acetyl groups on Sia are very labile to basic conditions and more stable under acidic conditions. Although no quantitative data are available for the lability of *O*-acetyl group during the DMB-derivatization procedures, quantitative analysis is basically possible as long as authentic *O*-acetylated Sia compounds are used as a standard. It is of interest to note that the 8-*O*-acetyl ester is

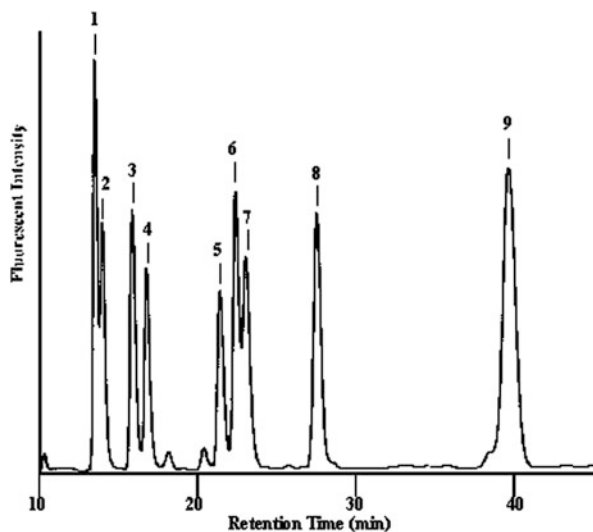

**Fig. 2** Fluorometric HPLC of sialic acid. DMB-derivatives of Neu5Ac, Neu5Gc, Kdn, and their 8- or 9-*O*-sulfated forms are shown. DMB-derivatives were applied to an ODS column, eluted with acetonitrile/methanol/0.05% trifluoroacetic acid (4: 6: 90 by volume), and detected fluorometrically at excitation/emission 373/448 nm. The retention times (min) for the DMB-derivatives are: 13.9, DMB-Kdn9S (1); 14.4, DMB-Kdn8S (2); 16.3, DMB-Neu5Gc9S (3); 17.2, DMB-Neu5Gc8S (4); 21.8, DMB-Neu5Ac9S (5); 22.8, DMB-Kdn (6); 23.4, DMB-Neu5Ac8S (7); 27.9, DMB-Neu5Gc (8); 40.0, DMB-Neu5Ac (9)

more labile than a 9-*O*-acetyl ester, and acetyl-groups tend to migrate to the C-9 position at the end, even under neutral conditions at room temperature [65]. However, no such migration takes place with the 8-*O*-sulfate ester of Sia.

In Step 3, DMB derivatives of Neu5Ac, Neu5Gc, and Kdn are separately quantitated by HPLC on an octadecylsilyl (ODS) column using acetonitrile/methanol/water (9:7:84 by volume) as the elution solution [24]. The *O*-acetylated Sia are eluted more slowly than the corresponding non-*O*-acetylated Sia. To separate the various SiaS from each other, an acidic solution of acetonitrile/methanol/0.05% trifluoroacetic acid (9:7:84 by volume) [64] is recommended. This solution will enable the separation of DMB derivatives of Neu5Ac8S, Neu5Ac9S, Neu5Gc8S, and Neu5Gc9S. For the separation of DMB derivatives of Kdn8S and Kdn9S, a solution with higher polarity, acetonitrile/methanol/0.05% trifluoroacetic acid (4:6:90 by volume), is appropriate [64]. The described protocol enabled the separation of DMB derivatives of nine different sulfated and non-sulfated Neu5Ac, Neu5Gc, and Kdn (Fig. 2). The relative peak area represents the proportion of the peak area of each DMB-Sia to that of DMB-Neu5Ac, and can be used as an index for relative detection efficiency. Typical relative peak areas to that of DMB-Neu5Ac are shown in Table 1.

**Table 1** Typical relative peak areas for the DMB-derivatives to that for DMB-Neu5Ac

DMB derivative of	Peak area/pmol <sup>a</sup>	Relative peak area <sup>b</sup>
Neu5Ac	$5.0 \times 10^6$	1.0
Neu5Ac8S	$2.8 \times 10^6$	$0.65 \pm 0.09$
Neu5Ac9S	$2.3 \times 10^6$	$0.48 \pm 0.02$
Neu5Gc	$3.8 \times 10^6$	$0.72 \pm 0.05$
Neu5Gc8S	$3.0 \times 10^6$	$0.63 \pm 0.04$
Neu5Gc9S	$3.3 \times 10^6$	$0.64 \pm 0.04$
Kdn	$2.3 \times 10^6$	$0.46 \pm 0.01$
Kdn8S	$0.9 \times 10^6$	$0.21 \pm 0.04$
Kdn9S	$2.0 \times 10^6$	$0.40 \pm 0.02$

<sup>a</sup>The fluorescent peak area is divided by the amounts (pmol) of the indicated Sia and SiaS glycosides

<sup>b</sup>Relative peak areas of the Sia and SiaS derivatives are shown as peak area/pmol values relative to that of Neu5Ac glycoside. The deviations from the average are shown for two independent experiments

## 2.2 Detection of Oligo/Polysialic Acids

When samples containing diSia, oligoSia, and polySia structures at 10–100  $\mu\text{g}$  are analyzed, conventional methods including methylation analysis [66], NMR (nuclear magnetic resonance) [67], and mild acid hydrolysis-TLC (thin layer chromatography) [68] can be applied. However, the amount of these types of glycoproteins is often too small to be analyzed by conventional methods. The fact that the di-, oligo-, and polySia-modification of glycoproteins has not often been reported suggests that these species in an organism is rare. As highly sensitive chemical methods to analyze minute amounts of di-, oligo-, and polySia were developed using highly sensitive fluorescent reagents [62, 69–72], the number of studies identifying di-, oligo-, and polySia increased gradually [43]. Therefore, in this chapter we are focusing on the chemical and immunochemical detection of small amounts (picogram to nanogram amounts) of sialic acid which may serve as powerful tools to reveal the importance of di-, oligo-, and polySia in nature.

The polySia glycotope exhibits structural diversity in the sialic acid components (Neu5Ac, Neu5Gc, and Kdn) in the inter-sialyl linkages ( $\alpha 2 \rightarrow 5O_{glycolyl}$ ,  $\alpha 2 \rightarrow 8$ ,  $\alpha 2 \rightarrow 9$ , and  $\alpha 2 \rightarrow 8/9$ ) and in the degree of polymerization (DP) [43, 68]. With a highly specific reagent for  $\alpha$ -keto acid [62], a specific labeling of di-, oligo-, and polySia became possible and products could be detected by anion exchange chromatography. This broadly used method was first developed by us [70] and was further improved in later studies [73]. With this method, di-, oligo-, and polySia on glycoproteins were frequently demonstrated [43, 53, 54].



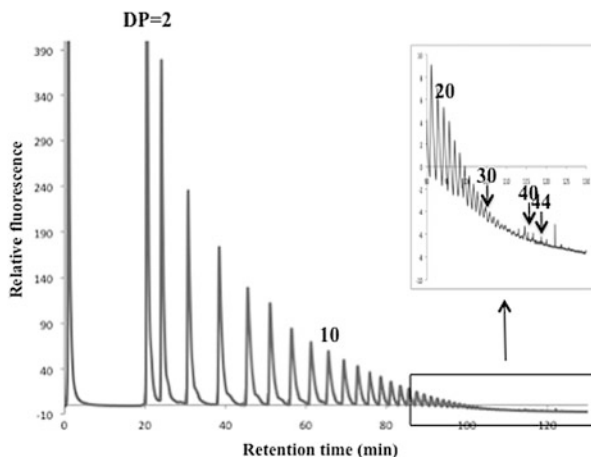

**Fig. 3** Mild acid hydrolysis-fluorometric HPLC analysis. Mini Q anion exchange chromatography of  $\alpha 2 \rightarrow 8$ -linked di/oligo/polyNeu5Ac-DMB.  $\alpha 2 \rightarrow 8$ -Linked oligo/polyNeu5Ac was labeled with DMB and applied to a mini Q HR5/5 anion exchange column (1 mL,  $\text{Cl}^-$ -form). The column was eluted with 5 mM Tris-HCl (pH 8.0) with a gradient from 0 to 0.3 M NaCl for 75 min and 0.3 M NaCl to 0.4 M NaCl for 120 min after 15 min wash. The elution was monitored by a fluorescence detector (set at wavelength of 373 nm excitation and 448 nm emission). Each peak is assigned from the order of elution, based on DP

### 2.2.1 Mild Acid Hydrolysis-Fluorometric HPLC Analysis

Gangliosides, glycoproteins in solution or blotted on polyvinylidene difluoride (PVDF) membrane (Immobilon P, Millipore, U.S.A) are hydrolyzed with 0.01 N trifluoroacetic acid (TFA) at  $50^\circ\text{C}$  for 1 h to release di-, oligo-, and polySia units from the glycoconjugates. The samples were then freeze dried. To release di-, oligo-, and polySia, 20  $\mu\text{L}$  of 0.01 N TFA and 20  $\mu\text{L}$  of 7 mM DMB solution in 5.0 mM TFA containing 1 M 2-mercaptoethanol and 18 mM sodium hydrosulfite, are added to the samples. These samples are incubated at  $50^\circ\text{C}$  for 1–2 h or at  $4^\circ\text{C}$  overnight. The DMB-labeled samples are applied to an HPLC analysis. HPLC equipped with a Mono or Mini Q HR5/5 (0.5  $\times$  5 cm, GE, Uppsala, Sweden), Resource Q (1 mL, GE, Uppsala, Sweden), CarbopacPA-100, or DNapak1 PA-120 (4  $\times$  250 mm, Dionex) anion exchange column, and a fluorescence detector (FP-2025, JASCO). After equilibrating the column with 5 mM to 20 mM Tris-HCl (pH 8.0) at  $26^\circ\text{C}$ , samples are applied and the DMB-labeled di-, oligo-, and polySia are eluted at a flow rate of 0.5–1.0 mL/min with a linear gradient of NaCl (0  $\rightarrow$  0.4 M) after 15–30 min wash with 5–20 mM Tris-HCl (pH 8.0) (flow through). The fluorescence of the DMB-labeled samples is detected with a fluorescence detector at excitation 373 nm and emission 448 nm. The separation is dependent on the anion exchange column and buffer conditions. Mono Q and Resource Q are suitable for shorter oligo- and polymers. Mini Q and Carbopac PA-100 have almost the same ability to separate polymers with DPs ranging from 2 to DP 50–90 (Fig. 3).

Additionally, this method can be applied to determine the glycosidic linkage ( $\alpha 2 \rightarrow 8$ ,  $\alpha 2 \rightarrow 9$ , and  $\alpha 2 \rightarrow 5$ ) of diSia units (Neu5Ac $\rightarrow$ Neu5Ac, Neu5Ac $\rightarrow$ Neu5Gc, Neu5Gc $\rightarrow$ Neu5Ac, Neu5Gc $\rightarrow$ Neu5Gc, Kdn $\rightarrow$ Kdn, and so on) and their component Sia species [70] according to their elution time. If the sample is pure sialyloligo or -polymer, it can be detected on a UV detector or a pulse amperometric detector (PAD) [71], instead of the DMB-derivatization/fluorometric detection method.

To increase the sensitivity, especially in higher DP, because the labeling site is one per chain, it is recommended to separate the polySia on an anion exchange column and to label each fraction with DMB labeling after hydrolysis of the sample with 0.1 N TFA at 80°C for 1–2 h [72]. The sensitivity increases depending on their DP.

### 2.2.2 Fluorometric C<sub>7</sub>/C<sub>9</sub> Analysis

The periodate treatment of sialic acid residing in non-reducing terminal ends is a well-known method to modify the terminal sialic acid [74]. To observe and quantify the internal sialic acids of  $\alpha 2 \rightarrow 8$ -linked di-, oligo-, and polySia-containing glycoconjugates, sensitive chemical methods were developed with highly sensitive fluorescent labeling reagents (DMB) as described above [69].

To perform the fluorometric C<sub>7</sub>/C<sub>9</sub> analysis, several reagents are prepared. Solutions A–G are prepared as follows: solution A, 40 mM sodium acetate buffer (pH 5.5); solution B, 0.25 M periodate; solution C, 3% ethyleneglycol; solution D, 0.2 M sodium borohydride in 0.2 M sodium borate buffer (pH 8.0); solution E, 0.2 M trifluoroacetic acid (TFA); solution F, 0.01 M trifluoroacetic acid; solution G, 7 mM 1,2-diamino-4,5-methylenedioxybenzene (DMB) in 5 mM trifluoroacetic acid containing 1 M 2-mercaptoethanol and 18 mM sodium hydrosulfite. For glycoproteins or oligosaccharides in solution, samples (0.25–1,000 ng as Sia) are dissolved in 25  $\mu$ L of solution A and 2  $\mu$ L of solution B are added. After being left at 0°C for 3 h in the dark, 5  $\mu$ L of solution C and 32  $\mu$ L of solution D are added successively and allowed to stand at 0°C overnight. To the resultant mixture is added a pre-determined amount of Kdo (for example, as an internal standard for quantitating the resultant sialic acids) and the volume is set to 100  $\mu$ L with water. Following further addition of 100  $\mu$ L of solution E to adjust to 0.1 M TFA, the mixture is hydrolyzed at 80°C for 2–4 h. The hydrolysate is lyophilized by a Speed Vac. After addition of 20  $\mu$ L of solution F to the samples, 20  $\mu$ L of solution G is added and the samples are incubated at 50°C for 2 h (it depends on the DP). The resulting supernatants are applied to an HPLC for analysis. This method can also be applied to the samples blotted on the PVDF membrane.

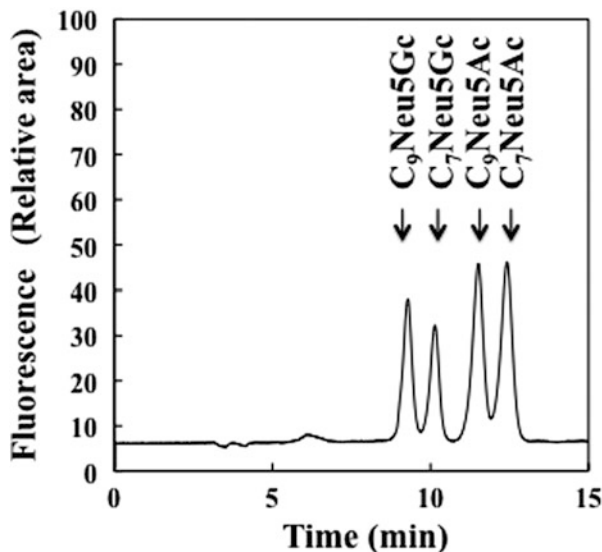

**Fig. 4** HPLC profile in the fluorometric  $C_7/C_9$  analysis. A typical elution profile of DMB derivatives of  $C_7$ -analogues and authentic sialic acids ( $C_9$ ) on the fluorometric HPLC. Disialyl sialitols, 12.5 ng each of Neu5Ac $\alpha$ 2 $\rightarrow$ 8Neu5Ac $\alpha$ 2 $\rightarrow$ 8-Neu5Ac-ol and Neu5Gc $\alpha$ 2 $\rightarrow$ 8Neu5Gc $\alpha$ 2 $\rightarrow$ 8-Neu5Gc-ol, were subjected to the periodate oxidation/reduction/hydrolysis, DMB derivatization, and fluorometric HPLC on a TSK-gel ODS-120T column (250  $\times$  4.6 mm i.d.). The column was eluted with acetonitrile/methanol/water (9:7:84 by volume) at 1.0 mL/min at 26°C. Elution profile was monitored by measurement of fluorescence: excitation, 373 nm; emission, 448 nm

The DMB-labeled sialic acids are applied to the HPLC equipped with a TSK-gel ODS-120T column (250  $\times$  4.6 mm i.d., Tosoh), and a fluorescence detector (FP-2025, JASCO). The column is equilibrated using acetonitrile/methanol/water (9:7:84 by volume) at 26°C. Then 2–20  $\mu$ L of the supernatants are applied to HPLC analysis for an isocratically flow at 1.0 mL/min and the DMB-labeled sialic acid is detected with a fluorescence detector at an excitation of 373 nm and an emission at 448 nm (Fig. 4). The estimate of the ratios of the quantity of internal sialic acid residues ( $C_9$ (Sia)) to that of total sialic acid residues ( $C_7$ (Sia) +  $C_9$ (Sia)) can then be obtained.

The following limitations should be noted with respect to this method. First, this method is applicable to only  $\alpha$ 2 $\rightarrow$ 8-linked oligo/polymer of *N*-acylneuraminic acid, and cannot be used for DP analyses of  $\alpha$ 2 $\rightarrow$ 9,  $\alpha$ 2 $\rightarrow$ 8/ $\alpha$ 2 $\rightarrow$ 9-mixed linkage polymers, or  $\alpha$ 2 $\rightarrow$ 5*O*<sub>glycolyl</sub>-linkage. Second, the  $C_9$ -derivatives formed do not always arise from  $\alpha$ 2 $\rightarrow$ 8-linkages, because 8-*O*-substituted Neu5Acyl residues may also give the same  $C_9$ -derivatives. Therefore, mild alkali treatment of samples is usually carried out prior to periodate oxidation. Third, the molar proportion of

C9-derivatives to C7-derivatives does not directly represent the DP unless it is a linear polySia chain. Thus, the method does not yield the DP for multiply sialylated chains present in the same sample. In general, glycoproteins have more than one glycan chain and even one glycan chain bears two to four non-reducing terminal residues that may be terminated by monoSia or oligoSia residues.

### 3 Immunochemical Analyses of Sialic Acid and Sialoglycoconjugates

#### 3.1 Immunochemical Detection of Kdn and O-Sulfated Sialic Acids

##### 3.1.1 Immunodetection of Kdn Using Kdn-Specific Antibodies and Kdn'ase Sm

Kdn residues are resistant to various bacterial sialidases that are often used as reagents. However, a bacterial sialidase from *Sphingobacterium multivorum*, named Kdn'ase Sm, has a unique property in that it cannot cleave the glycosidic linkages of Neu5Ac and Neu5Gc in any free glycans and glycoconjugates but can specifically cleave the Kdn glycosidic linkages in free glycans, glycolipids and glycoproteins [75]. Similar Kdn'ases are also known in hepatopancreas of oyster. These enzymes strictly discriminate Kdn from Neu5Ac or Neu5Gc, and thus provide evidence for Kdn-specific recognition phenomena in these organisms.

Two monoclonal antibodies recognizing Kdn-containing epitopes have been developed. Kdn8Kdn, a mouse IgM, recognizes  $\alpha$ 2,8-linked oligo/polyKdn with more than two residues [76]. mAb.kdn3G, a mouse IgG, recognizes the Kdn $\alpha$ 2,3Gal-structure [77]. In immunohistochemistry, enzyme-linked immunosorbent assay (ELISA), and Western blotting using these antibodies, the results would be more reliable, if the loss of antigenicity by digestion with Kdn'ase Sm, a bacterial Kdn-specific sialidase (see below), was confirmed. Of the known lectins that recognize Neu5Ac, *Sambucus sieboldiana* lectin (SSA) can recognize the Kdn $\alpha$ 2,6Gal-linkage better than Neu5Ac $\alpha$ 2,6Gal-linkage [78]. In a combination of SSA and Kdn'ase Sm, Kdn $\alpha$ 2,6Gal-structure can be detected.

Kdn can be detected in free glycans, glycolipids, and glycoproteins in various cells and tissues from animals that express Neu5Ac. The expression level is very low in mammals.

##### 3.1.2 Immunodetection of SiaS Using Anti-SiaS Antibodies

Two monoclonal antibodies, mAb.3G9 and mAb.2C4, specifically recognizing SiaS, have been reported. The mAb.3G9 is a mouse IgM, and is highly specific for Neu5Ac8S. The antibody was generated using sea urchin sperm as an immunogen

[79]. The mAb.2C4 is also a mouse IgM and recognizes Neu5Ac8S and Neu5Gc8S, which can compensate for the binding specificity of mAb.3G9. This antibody was prepared using sea urchin egg low density detergent-insoluble membrane as an immunogen [64]. Detection limits of mAb.3G9 (1  $\mu\text{g}/\text{mL}$ ) and mAb.2C4 (culture supernatant) for Neu5Ac8S $\alpha 2 \rightarrow 8$ Neu5Ac $\alpha 2 \rightarrow 6$ Glc-Cer in ELISA were 0.94 and 1.9  $\text{pg}/\text{well}$ , respectively [64]. As in the case with Kdn'ase Sm in immunodetection of Kdn, an enzyme specifically destroying the SiaS epitopes would be a powerful tool for reliable detection. Commercially available arylsulfatases, which can remove sulfate group from sulfatide containing 3-*O*-sulfated Gal residue, have no activities on sulfate group on Sia. There are no known sulfatases that can act on the sulfate ester on SiaS. Therefore, immunochemical detection should be confirmed at least by chemical evidence to obtain reliable conclusions of the localization of SiaS.

Western blotting of sperm lysate of *Hemicentrotus pulcherrimus* using mAb.3G9 detects unique smear at 40–80 kDa, which corresponds to flagelliasialin containing Neu5Ac8S-capped  $\alpha 2,9$ -Neu5Ac-linked polymers [31, 32].

### **3.2 Immunochemical Detection of Oligo- and Polysialic Acids by Immunoblotting and ELISA**

#### **3.2.1 Immunodetection of Antibodies Recognizing di/oligo/polySia**

Antibodies are powerful tools for studying the structure and function of glycotopes. However, it is very important that the immunospecificities toward linkage, DP, and component are determined in detail before use.

For  $\alpha 2 \rightarrow 8$ -linked polySia glycotopes, several antibodies have been developed and used for the past 2 decades. Among the “so-called anti-polySia antibodies,” the horse polyclonal antibodies H.46 [80] and mouse mAb 735 [81] had been the only two whose immunospecificities were specifically determined by inhibition assays [82, 83]. The immunospecificity of the majority of other “anti-polySia antibodies” remained unknown until a comprehensive examination of the immunospecificity of these “anti-polySia” antibodies was carried out using an ELISA-based method with phosphatidylethanolamine-conjugated oligo- and polySia chains as antigens [84]. It was demonstrated that the “anti-polySia antibodies” discriminate in terms of the species of Sia residues and chain length. Our group has also developed a new anti-diSia antibody using copolymers of  $\alpha 2 \rightarrow 8$ -linked *N*-acetylneuraminyl *p*-vinylbenzylamide and acrylamide as an immunogen [85]. Thus, a large number of antibodies recognizing di-, oligo-, and/or polySia structures with defined specificities now exist and are summarized in Table 2.

**Table 2** Antigenic specificities and class of anti-oligo/polySia antibodies

Name of antibody	Animal origin <sup>a</sup> and immunoglobulin-type <sup>b</sup>	Sia in oligo/polySia recognized	Specificity on DP
<Group I > <i>anti-polySia antibody</i>			
H.46	ho, poly, IgM	Neu5Ac	DP $\geq$ 8
735	mo, mono, IgG2a	Neu5Ac	DP $\geq$ 11
<Group II > <i>anti-oligo + polySia antibody</i>			
12E3	mo, mono, IgM	Neu5Ac	DP $\geq$ 5
5A5	mo, mono, IgM	Neu5Ac	DP $\geq$ 3
2-2B	mo, mono, IgM	Neu5Ac	DP $\geq$ 4
OL.28	mo, mono, IgM	Neu5Ac	DP $\geq$ 4
2-4B	mo, mono, IgM	Neu5Gc	DP $\geq$ 2
kdn8kdn	mo, mono, IgM	KDN	DP $\geq$ 2
4F7	mo, mono, IgG	Neu5Ac <sup>c</sup>	n.d. <sup>d</sup>
<Group III > <i>anti-oligoSia antibody</i>			
S2-566	mo, mono, IgM	Neu5Ac	DP = 2 <sup>e</sup>
1E6	mo, mono, IgM	Neu5Ac	DP = 2
A2B5	mo, mono, IgM	Neu5Ac	DP = 3
AC1	mo, mono, IgG3	Neu5Gc	DP = 2–4

<sup>a</sup>ho horse, mo mouse

<sup>b</sup>poly polyclonal, mono monoclonal

<sup>c</sup> $\alpha$ 2 $\rightarrow$ 9-linkage specific

<sup>d</sup>n.d. not determined

<sup>e</sup>Neu5Ac $\alpha$ 2 $\rightarrow$ 8Neu5Ac $\alpha$ 2 $\rightarrow$ 3Gal. Gal residue is required

Interestingly, the anti-oligo/polySia antibodies can be classified into three groups, based on the immunospecificity for chain length and the involvement of the non-reducing terminus in the antibody recognition site. Group I consists of the “anti-polySia antibodies” that recognize chains of  $\alpha$ 2 $\rightarrow$ 8-linked Sia with a DP  $\geq$  8, including fully extended polySia chains with a DP  $\sim$  200–400. These antibodies recognize the helical conformation formed by Sia residues within the internal region of the polySia chains, but not the non-reducing terminal residues. Group II antibodies, designated as “anti-oligo + polySia antibodies,” recognize both oligoSia with DP 2–7 and polySia chains. These antibodies recognize the distal portion of oligo/polySia chains, including the non-reducing termini. Group III antibodies, designated as “anti-oligoSia antibodies,” recognize specific conformations of di- and oligoSia with a DP 2–4, but do not bind polySia. Group III antibodies can be further classified into two subgroups. One group is composed of “anti-diSia antibodies” that recognize the diNeu5Ac structure (S2-566, 1E6), and the other includes the “anti-oligoSia antibodies” (AC1). Group II and III antibodies would be useful for detecting and determining di- and oligoSia structures, in combination with treatment with exo- and endo-sialidases, as described below (Table 3). The antibodies can be applied to Western blotting (Fig. 5a), immunocytochemistry (Fig. 5b), and FACS analysis (Fig. 5c) [86].

**Table 3** Reactivity of di-, oligo-, and polySia chains toward biochemical probes

Biochemical probes	diSia	oligoSia	polySia
	DP = 2	DP = 3-7	DP ≥ 8
Group I antibody	–	–	+
Group II antibody	–	+	+
Group III antibody	+	+ or –	–
Endo-sialidase (endoN)	–	– or + <sup>a</sup>	+
Endosialidase <sup>b</sup>	–	+	+
α2,3-Sialidase/α2,6-sialidase	–	–	–
α2,3-, α2,6, α2,8-Sialidase	+	+	+

+ reactive or sensitive, – unreactive or insensitive

<sup>a</sup>+ in case of DP = 6,7

<sup>b</sup>Refer to [91]

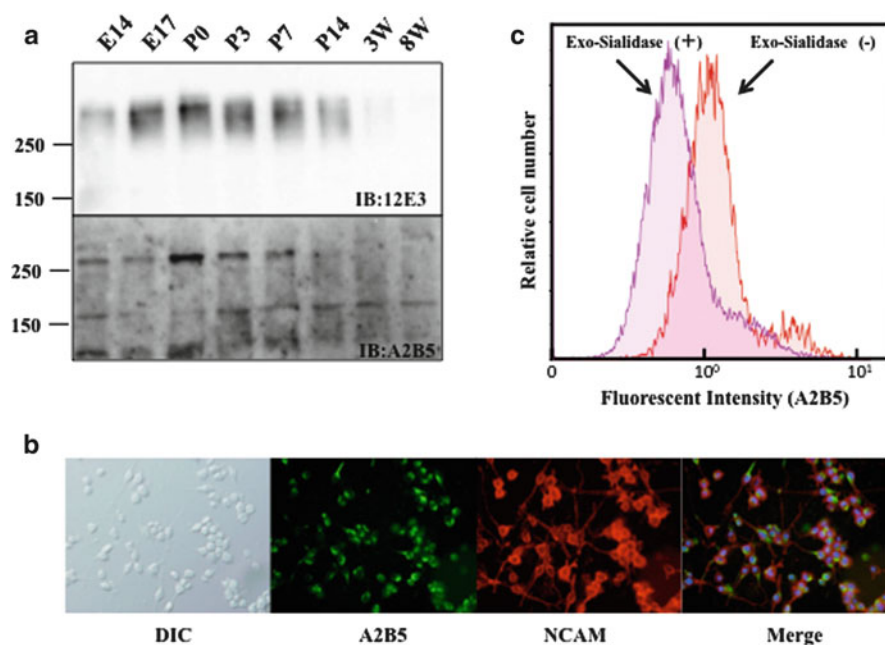

**Fig. 5** TriNeu5Ac epitopes in mouse brain homogenates and Neuro2A cells. (a) Western blots of mouse brain homogenates with anti-trSia antibody (A2B5) and anti-oligo/polySia antibody (12E3). The photos are cited from [85]. (b) Cell surface staining with A2B5 using fluorescent microscopy. The mouse neuroblastoma cells were incubated with retinoic acid at 20  $\mu$ M in 2% FBS in DMEM and differentiated into neurons. At day 3, the cell surfaces were immunostained with anti-triSia antibody (A2B5, Green), and anti-NCAM antibody (Red). (c) Cell surface immunostaining with anti-triSia antibody using flowcytometer. Neuro2A cells were transfected with ST8Sia III gene although the cells have its enzyme endogenously. The stably ST8SiaIII expressing cells were immunostained with anti-triSia antibody before, and after exosialidase treatment

Surprisingly, anti-diSia antibodies obtained after immunization with gangliosides, developed, and used as anti-ganglioside antibodies can recognize cytosolic proteins such as carbonic anhydrase II [87] although they recognize diSia epitope on glycoproteins. These phenomena might explain the cytosolic immunostaining with those anti-ganglioside antibodies in part. The protein mimicry should be considered and confirm the epitope with those antibodies.

### 3.2.2 Use of Endo-Sialidases and Exo-Sialidases for the Detection of OligoSia and PolySia

Endo-sialidase (for a detailed description see Jakobsson et al. [88]) can serve as a specific molecular probe to detect and selectively modify  $\alpha 2 \rightarrow 8$ -linked polySia chains. The soluble enzyme derived from bacteriophage K1F, designated endoN, catalyzes the depolymerization of polySia chains as follows:  $(\rightarrow 8\text{Neu5Acyl}\alpha 2 \rightarrow)_n - X$  ( $n \geq 5$ )  $\rightarrow$   $(\rightarrow 8\text{Neu5Acyl}\alpha 2 \rightarrow)_{2-4} + (\rightarrow 8\text{Neu5Acyl}\alpha 2 \rightarrow)_2 - X$ . Two other types of endo-sialidases whose substrate specificities are different from the endoN of bacteriophage K1F [89] have been isolated: endoNE [90] and an endosialidase [91] from a bacteriophage. The minimum chain length required for cleavage is  $\text{DP} \geq 11$  and  $\text{DP} \geq 3$ , respectively. Exo-sialidases have been isolated that cleave specific linkages, for example,  $\alpha 2,3$ -sialidase (NANase I),  $\alpha 2,3$ -,  $\alpha 2,6$ -sialidase (NANase II),  $\alpha 2,3$ -,  $\alpha 2,6$ -,  $\alpha 2,8$ -sialidase (NANase III), and  $\alpha 2,3$ -,  $\alpha 2,6$ -,  $\alpha 2,8$ -, and  $\alpha 2,9$ -sialidase. As the endoN is insensitive toward di- and oligoSia structures and they should be cleavable by these exosialidases, it is possible to confirm the length of given di-, oligo-, and polySia chains in conjunction with endo- and exo-sialidase treatments before and after immunostaining with anti-diSia, oligoSia, and polySia antibodies (See Table 3) [43, 53, 54].

Finne et al. established a specific probe for detection of polySia from endoNE that inactivates its enzymatic activity but not its ability to bind to polySia [92]. They succeeded in the detection of polySia-NCAM with this probe.

## 4 Immunohistochemistry for Specific Sialic Acids

When tissues are removed from the body during surgery, or during an autopsy, the onset of autolysis occurs promptly. This can thwart efforts to isolate nucleotides or certain enzymes and proteins, or to perform high quality histology. Thus tissue ideally has to be flash-frozen for extracts, or frozen in cryoprotective agents, or fixed, using different procedure-dependent fixatives, for analysis using histopathology. Immunohistochemistry is the process whereby tissue sections are probed with



antibodies to determine which cells contain epitopes of interest. The bound antibody is then detected using secondary and/or tertiary reagents, using fluorescent tags, or enzyme labels. If using enzyme labels, detection is facilitated using a number of different substrates, which produce precipitates, which are visible under the microscope. The nuclei are counterstained so that the morphology of the tissue can then be recognized during the analysis of the slides. In all immunohistochemistry experiments, to determine specificity, it is important to use specific blocking or inhibitory reagents. Processing of tissues into paraffin destroys many antigenic epitopes and additional unmasking methods often have to be used to detect antigens that are left after the processing. However, some changes are irreversible, such as the extraction of glycolipids during the paraffin embedding process. Immunohistochemistry remains an exact science, and appropriate use of controls and blocking agents are critical while analyzing results.

Lectins are carbohydrate-binding proteins, usually derived from plants, and have been used as tools to detect changes in glycan branching presentation on different cells. Mice that have been genetically altered to be deficient for specific sialyltransferases are then useful as important controls to demonstrate specificity of some lectin binding patterns. This was demonstrated nicely in a report [93] describing mice deficient in the sialyltransferases ST6Gal-I (transfers  $\alpha$ 2-6-linked Sia to Gal $\beta$ 1-4GlcNAc units, mostly on *N*-glycans), or ST3Gal-I (transfers  $\alpha$ 2-3-linked Sia to Gal $\beta$ 1-3GalNAc units, mostly on *O*-glycans). *Sambucus nigra* agglutinin (SNA) staining was lost in essentially all tissues of adult ST6Gal-I null mice, indicating that this is the only enzyme generating the Sia $\alpha$ 2-6Gal $\beta$ 1-4GlcNAc sequence. Lectin histochemistry with the  $\alpha$ 2-3-Sia-specific *Maackia amurensis* Hemagglutinin (MAH or MAL-II) showed loss of binding in almost all tissues of ST3Gal-I null mice. However, use of the other isolectins of the *Maackia amurensis* seeds, the MAL-I lectin, or the MAA lectin, showed continued binding to many tissues from the ST3Gal-I null animals (Fig. 6).

Different isolectins have been isolated from *Maackia amurensis* seeds [94, 95] and have been used as probes for sialic acids that are  $\alpha$ 2-3-linked to the penultimate galactose residues. The two most commonly used isolectins are the leucoagglutinin (MAL) and the hemagglutinin (MAH). Some commercial vendors use the term MAA to denote probes for sialic acids that are  $\alpha$ 2-3-linked, but in fact MAA is a mixture of MAL and MAH [96, 97]. In both MAL and MAH the glycine and asparagines involved in sugar binding were substituted by lysine and aspartic acid, respectively, [94, 98] and shown to be important in sialic acid binding. Investigators, using biochemical methods, have described the carbohydrate binding specificity of these lectins, and some have also described the lectin histochemistry profile. However, many of the histochemistry studies use MAL or MAA, and only rarely has MAH been used to ascribe the binding being used to identify  $\alpha$ 2-3-linked sialic acids. Most recently, it was shown that effective glycoanalysis with *Maackia amurensis* lectins requires a clear understanding of their binding specificities [99].

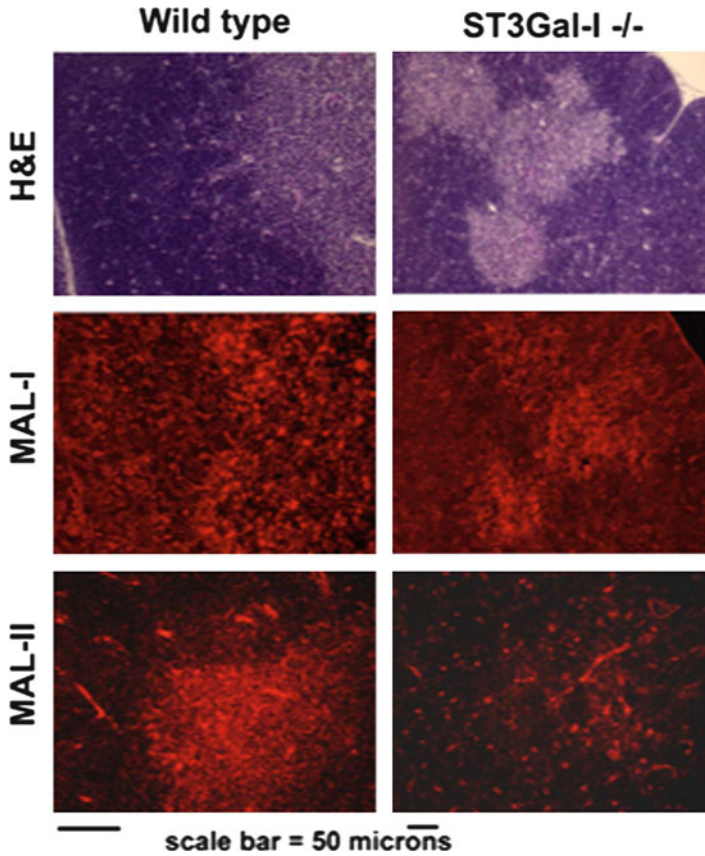

**Fig. 6** Differences in binding to frozen sections of mouse thymus, from wild type animal (*left column*) and from ST3Gal-I homozygous mutant (*right column*) observed with MAL-I and MAL-II, detected using the Cy3 fluorescent streptavidin label. *Top row* shows hematoxylin and eosin stained sections of the thymus, with dark blue cortex and lighter staining medulla. *Middle row* shows binding of MAL-I to thymus from both wild type (*left*) and ST3Gal-I null animals (*right*). *Bottom row* shows binding of MAL-II (MAH) lectin to the thymic medulla of the wild type mouse (*left*) and only minimally to structures in the thymic medulla from ST3Gal-I null mouse (*right*). Scale bar = 500  $\mu$ m

#### **4.1 Detection of 9-O-Acetylated Sialic Acids in Mammalian Tissues**

In mammalian tissues, 9-O-acetylation is often associated with gut mucins, neural gangliosides, and erythrocytes. Direct demonstration of the presence of 9-O-acetylated Sias in mammalian tissues was indirect (modifications of the PAS

technique) until the development of a chimeric dual-functional probe derived from influenza-C hemagglutinin esterase (InfCHE). This probe was constructed using a soluble and versatile form of the InfCHE that retains both the hemagglutinin and esterase activity and also has the binding properties of IgG Fc. The esterase activity is very similar to that of the native protein, and pH conditions can be adjusted to remove either 9-*O*-acetyl groups alone or both 9- and 7-*O*-acetyl groups completely (by causing migration of the latter to the 9-carbon position). DFP (di-isopropyl fluorophosphates) inactivation stabilizes and “unmasks” the hemagglutinin activity, resulting in a probe that specifically detects 9-*O*-acetylated sialic acids at ambient temperatures. Since CHE-FcD and CHE-Fc differ only by a single di-isopropyl group, each can be used as control for the other. Thus, when the CHE-Fc is used to remove 9-*O*-acetyl esters, the CHE-FcD can be used as an inactive control. Conversely, when CHE-FcD is used to probe for 9-*O*-acetylated Sias, the CHE-Fc can be used as a control for nonspecific binding. The two forms can even be used sequentially; i.e., treatment with CHE-Fc can be used to remove the 9-*O*-acetyl esters prior to probing with CHE-FcD, leaving only nonspecific staining, if any. It should be noted that the CHE-Fc does have a masked hemagglutinin activity, which can give a weak positive response at low temperatures, and even at ambient temperatures if the density of *O*-acetylated Sias is very high [6, 100–105].

Tissue expression of 9-*O*-acetylated Sias was best analyzed using frozen sections, using the probe CHE-FcD pre-complexed to the secondary antibody. There were differences in expression of 9-*O*-acetylated Sias in tissues isolated from rats and those from mice. As shown Fig. 7, there was abundant expression in rat liver, rat lung, in the glomeruli of rat kidney, and gray matter of rat brain. However, although mouse red blood cells and blood vessels showed expression of 9-*O*-acetylated Sias with the CHE-FcD probe, expression was not robust in mouse liver and mouse lung, but was instead present in the T-cell areas of lymphoid follicles in spleen, in the mature lymphoid medulla of the thymus, gray matter of the brain, and adrenal medulla.

Since the submaxillary gland mucins of many species have been reported to have high concentrations of 9-*O*-acetylated Sias, it was surprising to find no significant staining in the parenchyma of the rat or mouse submaxillary gland. Lipid overlays and protein blots confirmed that this is not due to inaccessibility of molecules on the tissue section. It is possible that the sialic acids of rat submaxillary mucins are 4-*O*- rather than 9-*O*-acetylated [106].

The hemagglutinin esterases of influenza C viruses and certain nidoviruses, including group 2 coronaviruses, recognize 9-*O*-acetylated Sia-containing glycoconjugates on the surface of host cells, and some can remove the 9-*O*-acetyl moieties [5, 107, 108]. Recombinant soluble forms of the bovine coronavirus HE with and without inactivation of the esterase active site have been reported, and these molecules may be more stable than the InfCHE reagents. However,

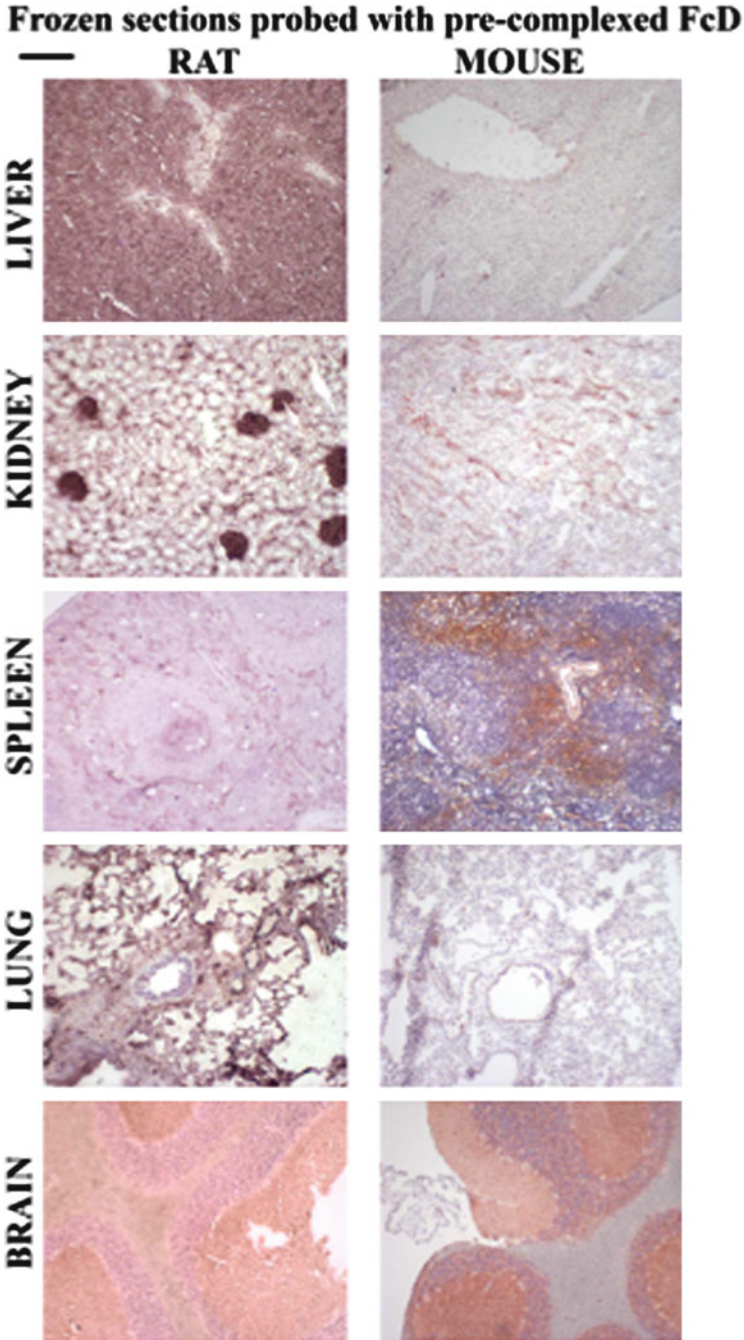

**Fig. 7** Differences in binding seen with the probe for 9-*O*-acetylated sialic acids, CHE-FcD, to mouse and to rat sections. As shown, 9-*O*-acetylated sialic acids are abundantly expressed in rat liver but not in mouse liver, although it is present on mouse red blood cells (*right*). It is also expressed on rat kidney glomeruli but not in the mouse kidney where it is present only on some

**Table 4** Expression of Neu5Gc in human tissues

All organs	Colon	Kidney	Epithelial carcinomas	Lymphomas, melanomas
Blood vessels	Luminal edge of epithelial cells	Glomeruli	About 30% of breast, ovary, prostate	Only on blood vessels

localization to tissue sections using immunohistochemistry has not yet been reported with the bovine coronaviruses reagents.

## 4.2 Detection of Neu5Gc in Human Tissues

Humans are genetically defective in synthesizing the common mammalian sialic acid Neu5Gc. It has been shown that Neu5Gc can be metabolically incorporated and covalently expressed on cultured human cell surfaces. Thus humans can also metabolically incorporate Neu5Gc into glycoproteins and glycolipids of human tumors, fetuses, and some normal tissues, likely from dietary sources (particularly red meats). Mass spectrometry confirmed the presence of small amounts of Neu5Gc in these human tissues.

As birds also do not synthesize Neu5Gc [109], it is possible to raise good anti-Neu5Gc antibodies in chickens. A polyclonal chicken anti-Neu5Gc was purified using a novel affinity method, utilizing sequential columns of immobilized human and chimpanzee serum sialo-glycoproteins, followed by specific elution from the latter column by free Neu5Gc. This purified anti-Neu5Gc antibody was used to characterize the expression of Neu5Gc in normal human and malignant tissues (Table 4).

Examination of frozen tissue sections showed expression in blood vessels, some epithelia, and in certain epithelial carcinomas [20, 110, 111]. Specificity of binding is confirmed by using a control IgY, and by inhibition using Neu5Gc rich chimpanzee serum. About 30% of breast, ovarian, and prostate carcinomas from humans showed expression of Neu5Gc (Fig. 8).

Other than expression within blood vessels within the malignant tissue, no expression was observed in melanomas and lymphomas using this three-step immunohistochemistry method. Paraffin sections showed a marked loss of expression, as did pre-incubation of frozen sections with methanol, indicating that the Neu5Gc epitopes are likely to be present mostly on glycolipids.



**Fig. 7** (continued) medullary vessels. There is a different distribution in spleen from rat and mouse, and is present in rat lungs but not in mouse lungs; and diffusely in rat brain (*left*) and only in gray matter of mouse brain (*right*). Scale bar = 50  $\mu$ m

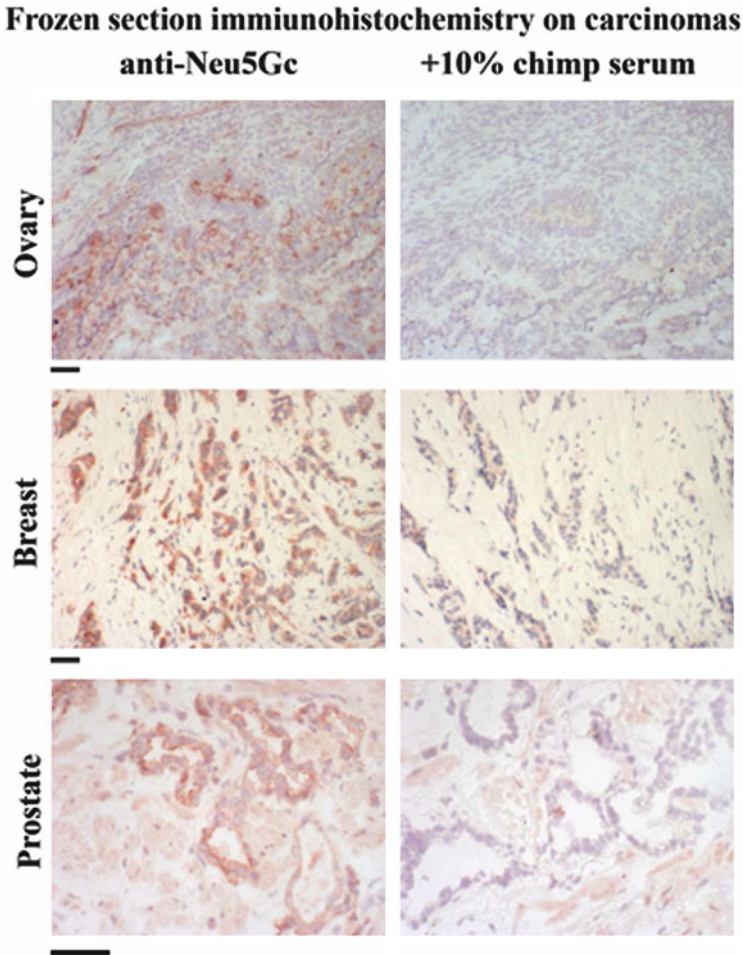

**Fig. 8** Examples of results from immunohistochemistry on human malignant tissues, using a purified polyclonal chicken anti-Neu5Gc antibody. As shown, Neu5Gc is expressed on blood vessels and on malignant cells (*left side*) and the binding is blocked when using Neu5Gc rich chimpanzee serum. *Scale bar* = 50  $\mu$ m

## 5 Conclusion and Perspectives

Structural diversity of Sia is not so large in each animal compared with that which we know in nature. In humans, Neu5Ac is a dominant Sia species, with NeuGc and Kdn contributing to only small amounts. 9-*O*-Acetylated Neu5Ac is a major modified Sia, but is still a minor form of total Neu5Ac in human. In rainbow trout, on the other hand, Neu5Ac, Neu5Gc, and Kdn appear to be equally expressed, although in a tissue-specific manner. Therefore, which Sia species each animal expresses for particular biological roles depends on the animal species. Evolutional pressures for

the selection of Sia species may come from critical interactions for survival of life, such as pathogen–host interactions, and species-specific sperm–egg interactions in fertilization. Thus, in some cases, a particular Sia species is specifically functional; in other cases, no specific Sia is necessary. The presence of Kdn-specific sialidase in bacteria, the preferential recognition of Neu5Gc by mouse siglec-2, and an inhibitory effect of polySia, but not di- and oligoSia, on homophilic binding of NCAM may exemplify the significance of the structural diversity of Sia species. Importantly, modifications of Sia are often changed dynamically, including the *O*-acetylation/de-*O*-acetylation cycle and transient degradation of polySia to oligoSia. However, currently there is very little knowledge available about the enzymes involved in these modification/re-modification reactions. Future studies will be directed toward this identification of Sia-modification enzymes and their genes.

## References

1. Angata T, Varki A (2002) Chemical diversity in the sialic acid and related  $\alpha$ -keto acids: an evolutionary perspective. *Chem Rev* 102:439–469
2. Schauer R, Kamerling JP (2003) In: Montreuil J, Vlieghehart JFG, Schachter H (eds) *Chemistry, biochemistry and biology of sialic acid, glycoproteins II*. Elsevier, Amsterdam, pp 243–402
3. Varki A (1997) Sialic acids as ligands in recognition phenomena. *FASEB J* 11:248–255
4. Varki A, Hooshmand F, Diaz S, Varki NM, Hedrick SM (1991) Developmental abnormalities in transgenic mice expressing a sialic acid-specific 9-*O*-acetyltransferase. *Cell* 65:65–74
5. Cariappa A, Takematsu H, Liu H, Diaz S, Haider K, Boboila C, Kalloo G, Connole M, Shi HN, Varki N, Varki A, Pillai S (2009) B cell antigen receptor signal strength and peripheral B cell development are regulated by a 9-*O*-acetyl sialic acid esterase. *J Exp Med* 206:125–138
6. Parameswaran R, Lim M, Arutyunyan A, Abdel-Azim H, Hurtz C, Lau K, Mischen M, Yu RK, von Itzstein M, Heisterkamp N, Groffen J (2013) *O*-Acetylated *N*-acetylneuraminic acid as a novel target for therapy in human pre-B acute lymphoblastic leukemia. *J Exp Med* 210:805–819
7. Mandal C, Schwartz-Albiez R, Vlasak R (2011) Functions and biosynthesis of *O*-acetylated sialic acids. *Top Curr Chem*. doi:10.1007/128\_2011\_310
8. Davies LRL, Varki A (2013) Why is *N*-glycolylneuraminic acid rare in the vertebrate brain? *Top Curr Chem*. doi:10.1007/128\_2013\_419
9. Hildebrandt H, Dityatev A (2013) Polysialic acid in brain development and synaptic plasticity. *Top Curr Chem*. doi:10.1007/128\_2013\_446
10. Wipfler D, Srinivasan GV, Sadick H, Kniep B, Arming S, Willhauck-Fleckenstein M, Vlasak R, Schauer R, Schwartz-Albiez R (2011) Differentially regulated expression of 9-*O*-acetyl GD3 (CD60b) and 7-*O*-acetyl-GD3 (CD60c) during differentiation and maturation of human T and B lymphocytes. *Glycobiology* 21:1161–1172
11. Lrhorfi LA, Srinivasan GV, Schauer R (2007) Properties and partial purification of sialate *O*-acetyltransferase from bovine submandibular glands. *Biol Chem* 388:297–306
12. Higa HH, Diaz S, Varki A (1987) Biochemical and genetic evidence for distinct membrane-bound and cytosolic sialic acid *O*-acetyl-esterases: serine-active-site enzymes. *Biochem Biophys Res Commun* 144:1099–1108
13. Shen Y, Kohla G, Lrhorfi AL, Sipos B, Kalthoff H, Gerwing GJ, Kamerling JP, Schauer R, Tiralongo J (2004) *O*-Acetylation and de-*O*-acetylation of sialic acids in human colorectal carcinoma. *Eur J Biochem* 271:281–290

14. Schauer R, Shukla AK (2008) Isolation and properties of two sialate-*O*-acetyl esterases from horse liver with 4- and 9-*O*-acetyl specificities. *Glycoconj J* 25:625–632
15. Schwardt O, Kelm S, Ernst B (2013) SIGLEC4 antagonists. *Top Curr Chem*. doi:10.1007/128\_2013\_498
16. Chou HH, Takematsu H, Diaz S, Iber J, Nickerson E, Wright KL, Muchmore EA, Nelson DL, Warren ST, Varki A (1998) A mutation in human CMP-sialic acid hydroxylase occurred after the Homo-Pan divergence. *Proc Natl Acad Sci USA* 95:11751–11756
17. Irie A, Koyama S, Kozutsumi Y, Kawasaki T, Suzuki A (1998) The molecular basis for the absence of *N*-glycolylneuraminic acid in humans. *J Biol Chem* 273:15866–15871
18. Taylor RE, Gregg CJ, Padler-Karavani V, Ghaderi D, Yu H, Huang S, Sorensen RU, Chen X, Inostroza J, Nizet V, Varki A (2010) Novel mechanism for the generation of human xeno-autoantibodies against the nonhuman sialic acid *N*-glycolylneuraminic acid. *J Exp Med* 207:1637–1646
19. Hedlund M, Padler-Karavani V, Varki NM, Varki A (2008) Evidence for a human-specific mechanism for diet and antibody-mediated inflammation in carcinoma progression. *Proc Natl Acad Sci USA* 105:18936–18941
20. Pham T, Gregg CJ, Karp F, Chow R, Padler-Karavani V, Cao H, Chen X, Witztum JL, Varki NM, Varki A (2009) Evidence for a novel human-specific xeno-auto-antibody response against vascular endothelium. *Blood* 114:5225–5235
21. Shilova N, Huflejt ME, Vuskovic M, Obukhova P, Navakouski M, Khasbiullina N, Pazynina G, Galanina O, Bazhenov A, Bovin N (2013) Natural antibodies against sialoglycans. *Top Curr Chem*. doi:10.1007/128\_2013\_469
22. Nadano D, Iwasaki M, Endo S, Kitajima K, Inoue S, Inoue Y (1986) A naturally occurring deaminated neuraminic acid, 3-deoxy-*D*-glycero-*D*-galactono-ulosonic acid (KDN). Its unique occurrence at the nonreducing ends of oligosialyl chains in polysialoglycoprotein of rainbow trout eggs. *J Biol Chem* 261:11550–11557
23. Inoue S, Kitajima K (2006) KDN (deaminated neuraminic acid): dreamful past and exciting future of the newest member of the sialic acid family. *Glycoconj J* 23:277–290
24. Inoue S, Kitajima K, Inoue Y (1996) Identification of 2-keto-3-deoxy-*D*-glycero-*D*-galactono- nononic acid (KDN, deaminoneuraminic acid) residues in mammalian tissues and human lung carcinoma cells. Chemical evidence of the occurrence of KDN glycoconjugates in mammals. *J Biol Chem* 271:24341–24344
25. Go S, Sato C, Yin J, Kannagi R, Kitajima K (2007) Hypoxia-enhanced expression of free deaminoneuraminic acid in human cancer cells. *Biochem Biophys Res Commun* 357:537–542
26. Prokazova NV, Mikhailov AT, Kocharov SL, Malchenko LA, Zvezdina ND, Buznikov G, Bergelson LD (1981) Unusual gangliosides of eggs and embryos of the sea urchin *Strongylocentrotus intermedius*. Structure and density-dependence of surface localization. *Eur J Biochem* 115:671–677
27. Kochetkov NK, Smimova GP, Chekareva NV (1976) Isolation and structural studies of a sulfated sialosphingolipid from the sea urchin *Echinocardium cordatum*. *Biochim Biophys Acta* 424:274–283
28. Kubo H, Irie A, Inagaki F, Hoshi M (1990) Gangliosides from the eggs of the sea urchin, *Anthocidaris crassispina*. *J Biochem (Tokyo)* 108:185–192
29. Ijuin T, Kitajima K, Song Y, Kitazume S, Inoue S, Haslam SM, Morris HR, Dell A, Inoue Y (1996) Isolation and identification of novel sulfated and nonsulfated oligosialyl glycosphingolipids from sea urchin sperm. *Glycoconj J* 13:401–413
30. Kitazume S, Kitajima K, Inoue S, Haslam SM, Morris HR, Dell A, Lennarz WJ, Inoue Y (1996) The occurrence of novel 9-*O*-sulfated *N*-glycolylneuraminic acid-capped  $\alpha$ 2 $\rightarrow$ 5-*O*-glycolyl-linked oligo/polyNeu5Gc chains in sea urchin egg cell surface glycoprotein. Identification of a new chain termination signal for polysialyltransferase. *J Biol Chem* 271:6694–6701
31. Miyata S, Sato C, Kitamura S, Toriyama M, Kitajima K (2004) A major flagellum sialoglycoprotein in sea urchin sperm contains a novel polysialic acid, an  $\alpha$ 2,9-linked poly-*N*-



- acetylneuraminic acid chain, capped by an 8-*O*-sulfated sialic acid residue. *Glycobiology* 14:827–840
32. Miyata S, Sato C, Kumita H, Toriyama M, Vacquier VD, Kitajima K (2006) Flagelliasialin: a novel sulfated  $\alpha$ 2,9-linked polysialic acid glycoprotein of sea urchin sperm flagella. *Glycobiology* 16:1229–1241
  33. Slomiany BL, Kojima K, Banas-Gruszka Z, Murty VL, Galicki NI, Slomiany A (1981) Characterization of the sulfated monosialosyltriglycosylceramide from bovine gastric mucosa. *Eur J Biochem* 119:647–650
  34. Slomiany A, Kojima K, Banas-Gruszka Z, Slomiany BL (1981) Structure of a novel sulfated sialoglycosphingolipid from bovine gastric mucosa. *Biochem Biophys Res Commun* 100:778–784
  35. Morimoto N, Nakano M, Kinoshita M, Kawabata A, Morita M, Oda Y, Kuroda R, Kakehi K (2001) Specific distribution of sialic acids in animal tissues as examined by LC-ESI-MS after derivatization with 1,2-diamino-4,5-methylenedioxybenzene. *Anal Chem* 73:5422–5428
  36. Bulai T, Bratosin D, Pons A, Montreuil J, Zanetta JP (2003) Diversity of the human erythrocyte membrane sialic acids in relation with blood groups. *FEBS Lett* 534:185–189
  37. Kawai Y, Takemoto M, Oda Y, Kakehi K, Ohta Y, Yamaguchi S, Miyake M (2000) Inhibition of in vitro fertilization of mouse gametes by sulfated sialic acid polymers. *Biol Pharm Bull* 23:936–940
  38. Kimura K, Mori S, Tomita K, Ohno K, Takahashi K, Shigeta S, Terada M (2000) Antiviral activity of NMSO<sub>3</sub> against respiratory syncytial virus infection in vitro and in vivo. *Antiviral Res* 47:41–51
  39. Kisa F, Yamada K, Miyamoto T, Inagaki M, Higuchi R (2007) Determination of the absolute configuration of sialic acids in gangliosides from the sea cucumber *Cucumaria echinata*. *Chem Pharm Bull(Tokyo)* 55:1051–1052
  40. Bhattacharjee AK, Jennings HJ, Kenny CP, Martin A, Smith IC (1976) Structural determination of the polysaccharide antigens of *Neisseria meningitidis* serogroups Y, W-135, and BO1. *Can J Biochem* 54:1–8
  41. Sato C, Kitajima K (2011) New functions of polysialic acid and its relationship to schizophrenia. *Trends Glycosci Glycotechnol* 23:221–238
  42. Mühlenhoff M, Rollenhagen M, Werneburg S, Gerardy-Schahn R, Hildebrandt H (2013) Polysialic acid: versatile modification of NCAM, SynCAM 1 and Neuropilin-2. *Neurochem Res* doi:10.1007/s11064-013-0979-2
  43. Sato C (2013) Polysialic acid. In: Tiralongo J, Martinez-Duncker I (eds) *Sialobiology: structure, biosynthesis, and function*, Bentham Science, pp 33–75. <http://www.eurekaselect.com/107046/volume/1>
  44. Rutishauser U (2008) Polysialic acid in the plasticity of the developing and adult vertebrate nervous system. *Nat Rev Neurosci* 9:26–35
  45. Kanato Y, Kitajima K, Sato C (2008) Complex formation of a brain-derived neurotrophic factor and glycosaminoglycans. *Glycobiology* 18:1044–1053
  46. Kanato Y, Ono S, Kitajima K, Sato C (2009) Direct binding of polysialic acid to a brain-derived neurotrophic factor depends on the degree of polymerization. *Biotech Biosci Biochem* 73:2735–2741
  47. Sato C, Yamakawa N, Kitajima K (2010) Measurement of glycan-based interactions by frontal affinity chromatography and surface plasmon resonance. *Methods Enzymol* 478:219–232
  48. Isomura R, Kitajima K, Sato C (2011) Structural and functional impairments of polysialic acid by a mutated polysialyltransferase found in schizophrenia. *J Biol Chem* 286:21535–21545
  49. Ono S, Hane M, Kitajima K, Sato C (2012) Novel regulation of FGF2-mediated cell growth by polysialic acid. *J Biol Chem* 287:3710–3722
  50. Vaithianathan T, Matthias K, Bahr B, Schachner M, Suppiramaniam V, Dityatev A, Steinhäuser C (2004) Neural cell adhesion molecule-associated polysialic acid potentiates

- $\alpha$ -amino-3-hydroxy-5-methylisoxazole-4-propionic acid receptor currents. *J Biol Chem* 279:47975–47984
51. Hammond MS, Sims C, Parameshwaran K, Suppiramaniam V, Schachner M, Dityatev A (2006) Neural cell adhesion molecule-associated polysialic acid inhibits NR2B-containing *N*-methyl-*D*-aspartate receptors and prevents glutamate-induced cell death. *J Biol Chem* 281:34859–34869
  52. Kambara Y, Shiba K, Yoshida M, Sato C, Kitajima K, Shingyoji C (2011) Mechanism regulating  $Ca^{2+}$ -dependent mechanosensory behaviour in sea urchin spermatozoa. *Cell Struct Funct* 36:69–82
  53. Sato C, Kitajima K (1999) Glycobiology of di- and oligosialyl glycotopes. *Trends Glycosci Glycotechnol* 11:371–390
  54. Sato C (2004) Glycobiology of di- and oligosialyl glycotopes. *Trends Glycosci Glycotechnol* 16:331–344
  55. Nadanaka S, Sato C, Kitajima K, Katagiri K, Irie S, Yamagata T (2001) Occurrence of oligosialic acids on integrin  $\alpha$ -5 subunit and their involvement in cell adhesion to fibronectin. *J Biol Chem* 276:33657–33664
  56. Sato C, Matsuda T, Kitajima K (2002) Neuronal differentiation-dependent expression of the disialic acid epitope on CD166 and its involvement in neurite formation in Neuro2A cells. *J Biol Chem* 277:45299–45305
  57. Yasukawa Z, Sato C, Sano K, Ogawa H, Kitajima K (2006) Identification of disialic acid-containing glycoproteins in mouse serum: a novel modification of immunoglobulin light chains, vitronectin, and plasminogen. *Glycobiology* 16:651–665
  58. Miyata S, Yamakawa N, Toriyama M, Sato C, Kitajima K (2011) Co-expression of two distinct polysialic acids,  $\alpha$ 2,8- and  $\alpha$ 2,9-linked polymers of *N*-acetylneuraminic acid, in distinct glycoproteins and glycolipids in sea urchin sperm. *Glycobiology* 21:1596–1605
  59. Aminoff D (1961) Methods for the quantitative estimation of *N*-acetylneuraminic acid and their application to hydrolysates of sialomucoids. *Biochem J* 81:384–392
  60. Uchida Y, Tsukada Y, Sugimori T (1977) Distribution of neuraminidase in *Arthrobacter* and its purification by affinity chromatography. *J Biochem (Tokyo)* 82:1425–1433
  61. Svennerholm L (1957) Quantitative estimation of sialic acids. II. A colorimetric resorcinol-hydrochloric acid method. *Biochim Biophys Acta* 24:604–611
  62. Hara S, Takemori Y, Yamaguchi M, Nakamura M, Ohkura Y (1987) Fluorometric high-performance liquid chromatography of *N*-acetyl- and *N*-glycolylneuraminic acids and its application to their microdetermination in human and animal sera, glycoproteins, and glycolipids. *Anal Biochem* 164:138–145
  63. Hara S, Yamaguchi M, Takemori Y, Furuhashi K, Ogura H, Nakamura M (1989) Determination of mono-*O*-acetylated *N*-acetylneuraminic acids in human and rat sera by fluorometric high-performance liquid chromatography. *Anal Biochem* 179:162–166
  64. Yamakawa N, Sato C, Miyata S, Maehashi E, Toriyama M, Sato N, Furuhashi K, Kitajima K (2007) Development of sensitive chemical and immunochemical methods for detecting sulfated sialic acids and their application to glycoconjugates from sea urchin sperm and eggs. *Biochimie* 89:1396–1408
  65. Kamerling JP, Schauer R, Shukla AK, Stoll S, Van Halbeek H, Vliegthart JF (1987) Migration of *O*-acetyl groups in *N*, *O*-acetylneuraminic acids. *Eur J Biochem* 162:601–607
  66. Finne J, Krusius T, Rauvala H (1977) Occurrence of disialosyl groups in glycoproteins. *Biochem Biophys Res Commun* 74:405–410
  67. Michon F, Brisson JR, Jennings HJ (1987) Conformational differences between linear  $\alpha$ 2,8-linked homosialooligosaccharides and the epitope of the group B meningococcal polysaccharide. *Biochemistry* 26:8399–8405
  68. Sato C, Kitajima K, Tazawa I, Inoue Y, Inoue S, Troy FA II (1993) Structural diversity in the  $\alpha$ 2-8-linked polysialic acid chains in salmonid fish egg glycoproteins. Occurrence of poly(Neu5Ac), poly(Neu5Gc), poly(Neu5Ac, Neu5Gc), poly(KDN), and their partially acetylated forms. *J Biol Chem* 268:23675–23684

69. Sato C, Inoue S, Matsuda T, Kitajima K (1998) Development of a highly sensitive chemical method for detecting  $\alpha$ 2,8-linked oligo/polysialic acid residues in glycoproteins blotted on the membrane. *Anal Biochem* 261:191–197
70. Sato C, Inoue S, Matsuda T, Kitajima K (1999) Fluorescent-assisted detection of oligosialyl units in glycoconjugates. *Anal Biochem* 266:102–109
71. Zhang Y, Lee YC (1999) Acid-catalyzed lactonization of  $\alpha$ 2,8-linked oligo/polysialic acids studied by high performance anion-exchange chromatography. *J Biol Chem* 274:6183–6189
72. Nakata D, Troy FA II (2005) Degree of polymerization (DP) of polysialic acid (polySia) on neural cell adhesion molecules (N-CAMS): development and application of a new strategy to accurately determine the DP of polySia chains on N-CAMS. *J Biol Chem* 275:38305–38316
73. Inoue S, Lin SL, Lee YC, Inoue Y (2001) An ultrasensitive chemical method for polysialic acid analysis. *Glycobiology* 11:759–767
74. Rohr TE, Troy FA (1980) Structure and biosynthesis of surface polymers containing polysialic acid in *Escherichia coli*. *J Biol Chem* 255:2332–2342
75. Kitajima K, Kuroyanagi H, Inoue S, Ye J, Troy FA 2nd, Inoue Y (1994) Discovery of a new type of sialidase, “KDNase,” which specifically hydrolyzes deaminoneuraminyl (3-deoxy-*D*-glycero-*D*-galacto-2-nonulosonic acid) but not *N*-acylneuraminyl linkages. *J Biol Chem* 269:21415–21419
76. Kanamori A, Inoue S, Xulei Z, Zuber C, Roth J, Kitajima K, Ye J, Troy FA 2nd, Inoue Y (1994) Monoclonal antibody specific for  $\alpha$ 2,8-linked oligo deaminated neuraminic acid (KDN) sequences in glycoproteins. Preparation and characterization of a monoclonal antibody and its application in immunohistochemistry. *Histochemistry* 101:333–340
77. Song Y, Kitajima K, Inoue Y (1993) Monoclonal antibody specific to  $\alpha$ 2,3-linked deaminated neuraminyl beta-galactosyl sequence. *Glycobiology* 3:31–36
78. Angata T, Matsuda T, Kitajima K (1998) Synthesis of neoglycoconjugates containing deaminated neuraminic acid (KDN) using rat liver  $\alpha$ 2,6-sialyltransferase. *Glycobiology* 8:277–284
79. Ohta K, Sato C, Matsuda T, Toriyama M, Lennarz WJ, Kitajima K (1999) Isolation and characterization of low density detergent-insoluble membrane (LD-DIM) fraction from sea urchin sperm. *Biochem Biophys Res Commun* 258:616–623
80. Sarff LD, McCracken G, Schiffer MS, Glode MP, Robbins JB, Ørskov I, Ørskov F (1975) Epidemiology of *Escherichia coli* K1 in healthy and diseased newborns. *Lancet* 1975:1099–1104
81. Frosch M, Gorge I, Boulnois GJ, Timmis KN, Bitter-Suremann D (1985) NZB mouse system for production of monoclonal antibodies to weak bacterial antigens: isolation of an IgG antibody to the polysaccharide capsules of *Escherichia coli* K1 and group B meningococci. *Proc Natl Acad Sci USA* 82:1194–1198
82. Jennings HJ, Roy R, Michon F (1985) Determinant specificities of the groups B and C polysaccharides of *Neisseria meningitidis*. *J Immunol* 134:2651–2657
83. Häyrynen J, Bitter-Suermann D, Finne J (1989) Interaction of meningococcal group B monoclonal antibody and its Fab fragment with  $\alpha$ 2-8-linked sialic acid polymers: requirement of a long oligosaccharide segment for binding. *Mol Immunol* 26:523–529
84. Sato C, Kitajima K, Inoue S, Seki T, Troy FA II, Inoue Y (1995) Characterization of the antigenic specificity of four different anti-( $\alpha$ 2,8-linked polysialic acid) antibodies using lipid-conjugated oligo/polysialic acids. *J Biol Chem* 270:8923–18928
85. Sato C, Fukuoka H, Ohta K, Matsuda T, Koshino R, Kobayashi K, Troy FA II, Kitajima K (2000) Frequent occurrence of pre-existing  $\alpha$ 2→8-linked disialic and oligosialic acids with chain lengths up to 7 Sia residues in mammalian brain glycoproteins. Prevalence revealed by highly sensitive chemical methods and anti-di-, oligo-, and poly-Sia antibodies specific for defined chain lengths. *J Biol Chem* 275:15422–15431
86. Inoko E, Nishiura Y, Tanaka H, Takahashi T, Furukawa K, Kitajima K, Sato C (2010) Developmental stage-dependent expression of an  $\alpha$ 2,8-trisialic acid unit on glycoproteins in mouse brain. *Glycobiology* 20:916–928

87. Yasukawa Z, Sato C, Kitajima K (2007) Identification of an inflammation-inducible serum protein recognized by anti-disialic acid antibodies as carbonic anhydrase II. *J Biochem* 141:429–441
88. Jakobsson E, Schwarzer D, Jokilampi A, Finne J (2012) Endosialidasas – versatile tools for the study of polysialic acid. *Top Curr Chem*. doi:10.1007/128\_2012\_349
89. Hallenbeck PC, Vimer ER, Yu F, Basseler B, Troy FA (1987) Purification and properties of a bacteriophage-induced endo-*N*-acetylneuraminidase specific for poly- $\alpha$ -2,8-sialosyl carbohydrate units. *J Biol Chem* 262:3553–3561
90. Pelkonen S, Perkonen J, Finne J (1989) Common cleavage pattern of polysialic acid by bacteriophage endosialidasas of different properties and origins. *J Virol* 63:4409–4416
91. Miyake K, Muraki T, Hattori K, Machida Y, Watanabe M, Kawase M, Yoshida Y, Iijima S (1997) Screening of bacteriophages producing endo-*N*-acetylneuraminidase. *J Ferm Bioeng* 84:90–93
92. Aalto J, Pelkonen S, Kalimo H, Finne J (2001) Mutant bacteriophage with non-catalytic endosialidase binds to both bacterial and eukaryotic polysialic acid and can be used as probe for its detection. *Glycoconj J* 18:751–758
93. Martin LT, Marth JD, Varki A, Varki NM (2002) Genetically altered mice with different sialyltransferase deficiencies show tissue-specific alterations in sialylation and sialic acid 9-*O*-acetylation. *J Biol Chem* 277:32930–32982
94. Yamamoto K, Konami Y, Irimura T (1997) Sialic acid-binding motif of *Maackia amurensis* lectins. *J Biochem* 121:756–761
95. Kim BS, Oh TK, Cho DH, Kim YJ, Koo WM, Kong KH, Kom H (2004) A sialic-acid binding lectin from the legume *Maackia fauriei*: comparison with lectin from *M. amurensis*. *Plant Sci* 167:1315–1321
96. Brinkmann-van der Linden ECM, Sonnenburg JL, Varki A (2002) Effects of sialic acid substitutions on recognition by *Sambucus nigra* agglutinin and *Maackia amurensis* Hemagglutinin. *Anal Biochem* 303:98–104
97. Nicholls JM, Bourne AJ, Chen H, Guan Y, Malik Peiris JS (2007) Sialic acid receptor detection in the human respiratory tract: evidence for widespread distribution of potential binding sites for human and avian influenza viruses. *Respir Res* 8:73–83
98. Imberty A, Gautier C, Lescar J, Perez S, Wyns L, Loris R (2000) An unusual carbohydrate binding site revealed by the structures of two *Maackia amurensis* lectins complexed with sialic acid-containing oligosaccharides. *J Biol Chem* 275:17541–17548
99. Geisler C, Jarvis DL (2011) Effective glycoanalysis with *Maackia amurensis* lectins requires a clear understanding of their binding specificities. *Glycobiology* 21:988–993
100. Herrler G, Rott R, Klenk HD, Muller HP, Shukla AK, Schauer R (1985) The receptor-destroying enzyme of influenza C virus is neuraminidase O-acetyltransferase. *EMBO J* 4:1503–1506
101. Vlasak R, Krystal M, Nacht M, Palese P (1987) The influenza C virus glycoprotein (HE) exhibits receptor-binding (hemagglutinin) and receptor-destroying (esterase) activities. *Virology* 160:419–425
102. Zimmer G, Reuter G, Schauer R (1992) Use of influenza C virus for detection of 9-*O*-acetylated sialic acids on immobilized glycoconjugates by esterase activity. *Eur J Biochem* 204:209–215
103. Klein A, Krishna M, Varki NM, Varki A (1994) 9-*O*-Acetylated sialic acids have widespread but selective expression: analysis using a chimeric dual-function probe derived from influenza C hemagglutinin-esterase. *Proc Natl Acad Sci USA* 91:7782–7786
104. Shi WX, Chammas R, Varki NM, Powell L, Varki A (1996) Sialic acid 9-*O*-acetylation on murine erythroleukemia cells affects complement activation, binding to I-type lectins, and tissue homing. *J Biol Chem* 271:31526–31532
105. Muchmore E, Varki A (1987) Selective inactivation of influenza C esterase: a probe for detecting 9-*O*-acetylated sialic acids. *Science* 236:1293–1295

106. Mehansho H, Carlson DM (1983) Induction of protein and glycoprotein synthesis in rat submandibular glands by isoproterenol. *J Biol Chem* 258:6616–6620
107. Schwegmann-Webels C, Herrier G (2006) Sialic acids as receptor determinants for coronaviruses. *Glycoconj J* 23:51–58
108. Langereis MA, van Vliet ALW, Boot W, deGroot RJ (2010) Attachment of mouse hepatitis virus to *O*-acetylated sialic acid is mediated by hemagglutinin-esterase and not by the spike protein. *J Virol* 2010:8970–8974
109. Schauer R (1982) Sialic acids: chemistry, metabolism and function, cell biology monographs, vol 10. Springer, Berlin
110. Tangvoranuntakul P, Gagneux P, Diaz S, Bardor M, Varki N, Varki A, Muchmore E (2003) Human uptake and incorporation of an immunogenic nonhuman dietary sialic acid. *Proc Natl Acad Sci USA* 100:12045–12050
111. Diaz SL, Padler-Karavani V, Ghaderi D, Hurtado-Ziola N, Yu H, Chen X, Brinkman-Van der Linden EC, Varki A, Varki NM (2009) Sensitive and specific detection of the non-human sialic acid *N*-glycolyneuraminic acid in human tissues and biotherapeutic products. *PLoS One* 4:e4241